

ASSEMBLY INSTRUCTIONS
COASTER FINE FURNITURE



Fine Furniture for every stage of life

193930BLK
Dining Table

ITEM: 193930BLK

ASSEMBLY INSTRUCTIONS



ASSEMBLY TIPS:

1. Remove hardware from box and sort by size.
2. Please check to see that all hardware and parts are present prior to start of assembly.
3. Please follow attached instructions in the same sequence as numbered to assure fast & easy assembly.



WARNING!

1. Don't attempt to repair or modify parts that are broken or defective. Please contact the store immediately.
2. This product is for home use only and not intended for commercial establishments.







ASSEMBLY TIME

20 MINUTES

PARTS IDENTIFICATION

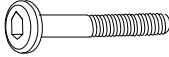
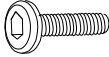
A	TOP		1PC
B	MOUNTING PLATE (PRE-ATTACHED TO TOP)		1PC
C	LEG		3PCS

HARDWARE IDENTIFICATION

1	ALLEN WRENCH (M4 x 63mm - BLK)		1PC
2	LONG BOLT (M6 x 50mm - RBW)		12PCS
3	SHORT BOLT (M6 x 35mm - RBW)		8PCS
4	LOCK WASHER (1/4" - BLK)		20PCS
5	SMALL FLAT WASHER (M6 x 13mm - RBW)		6PCS
6	BIG FLAT WASHER (1/4" - RBW)		14PCS
7	LEVELER (M6 x 14.8mm)		6PCS

ITEM: 193930BLK

ASSEMBLY INSTRUCTIONS



STEP 1

Unscrew all hardware Short Bolt, Lock Washer & Big Flat Washer.
Keep the hardware to be use in **STEP 5**.

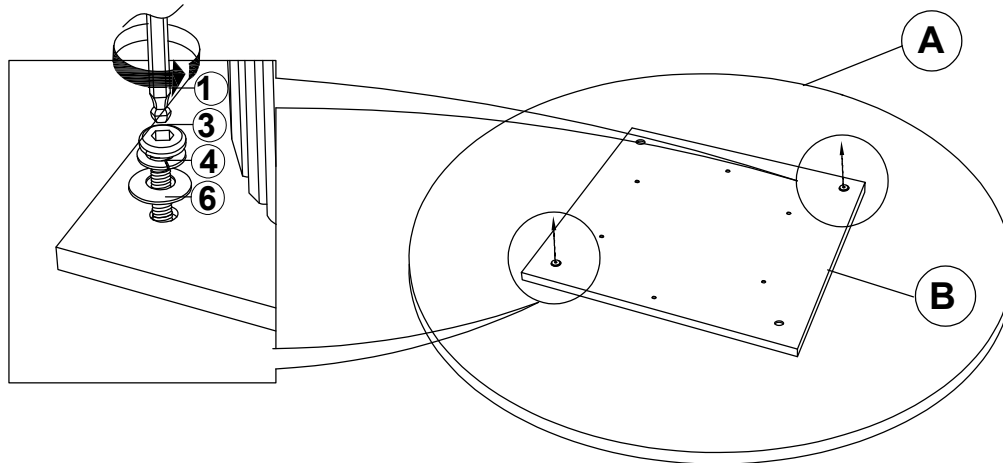

STEP 2

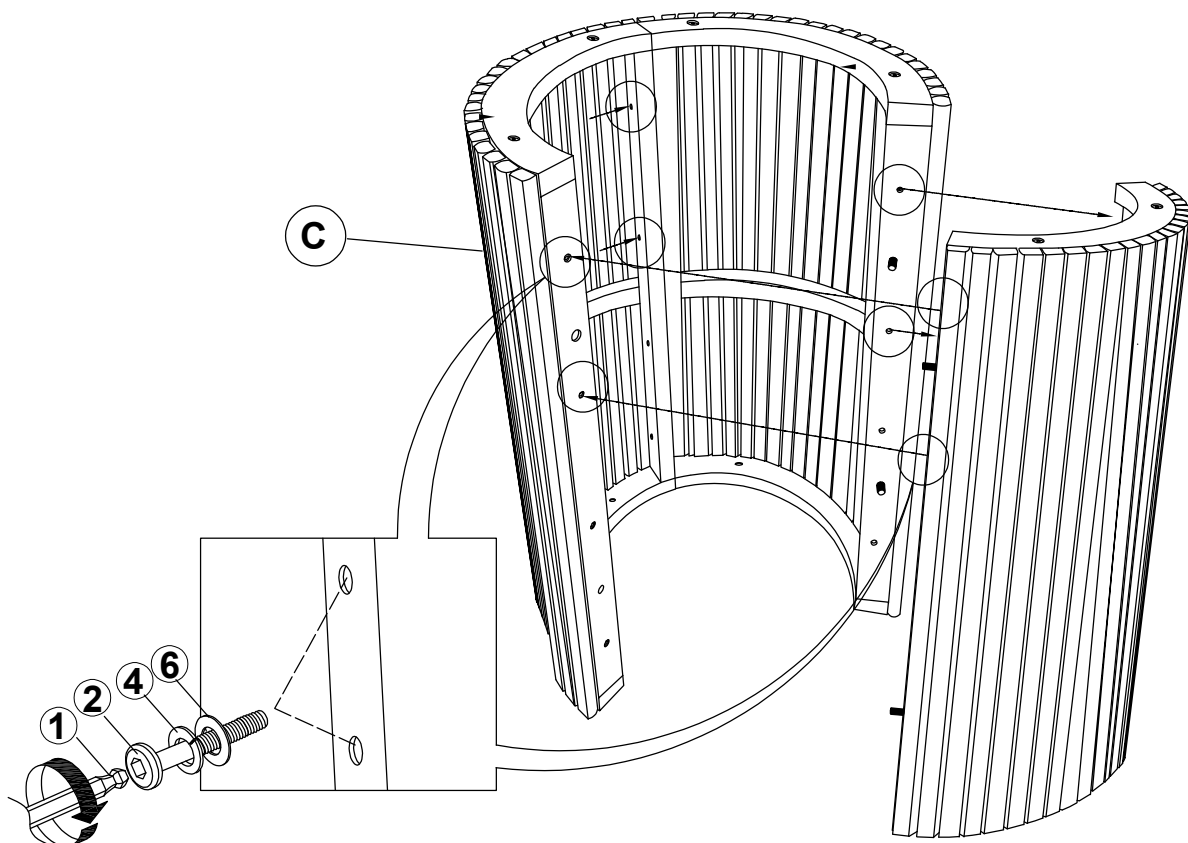

ITEM: 193930BLK

ASSEMBLY INSTRUCTIONS



STEP 3

Attention! Carefully turn the table base assembly to the other side before proceeding with the next step.

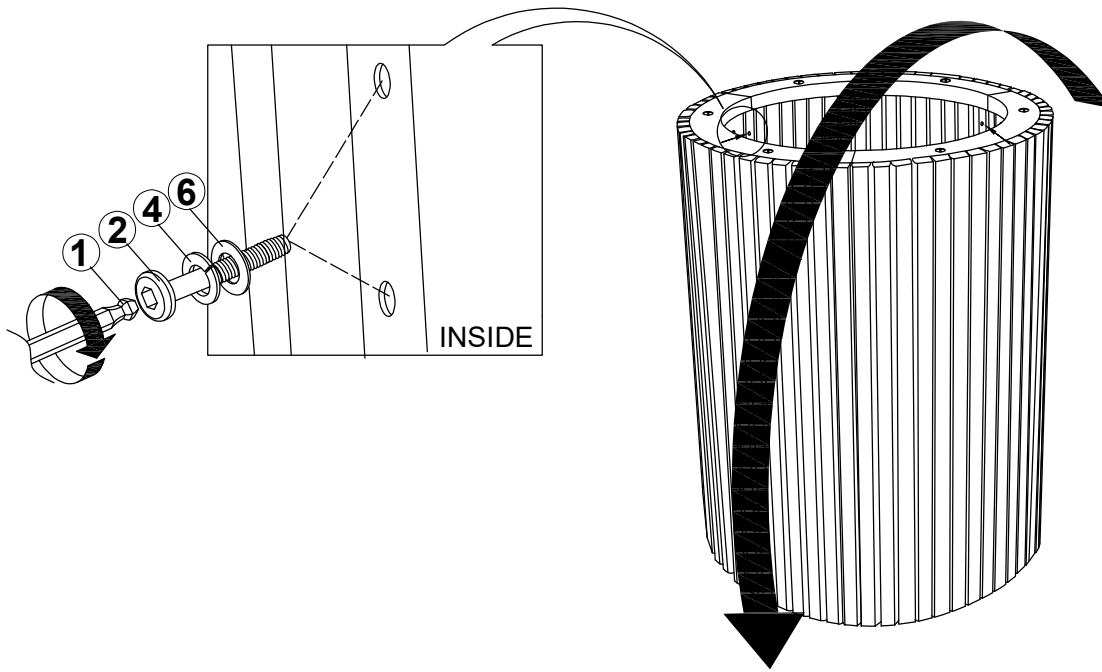

STEP 4

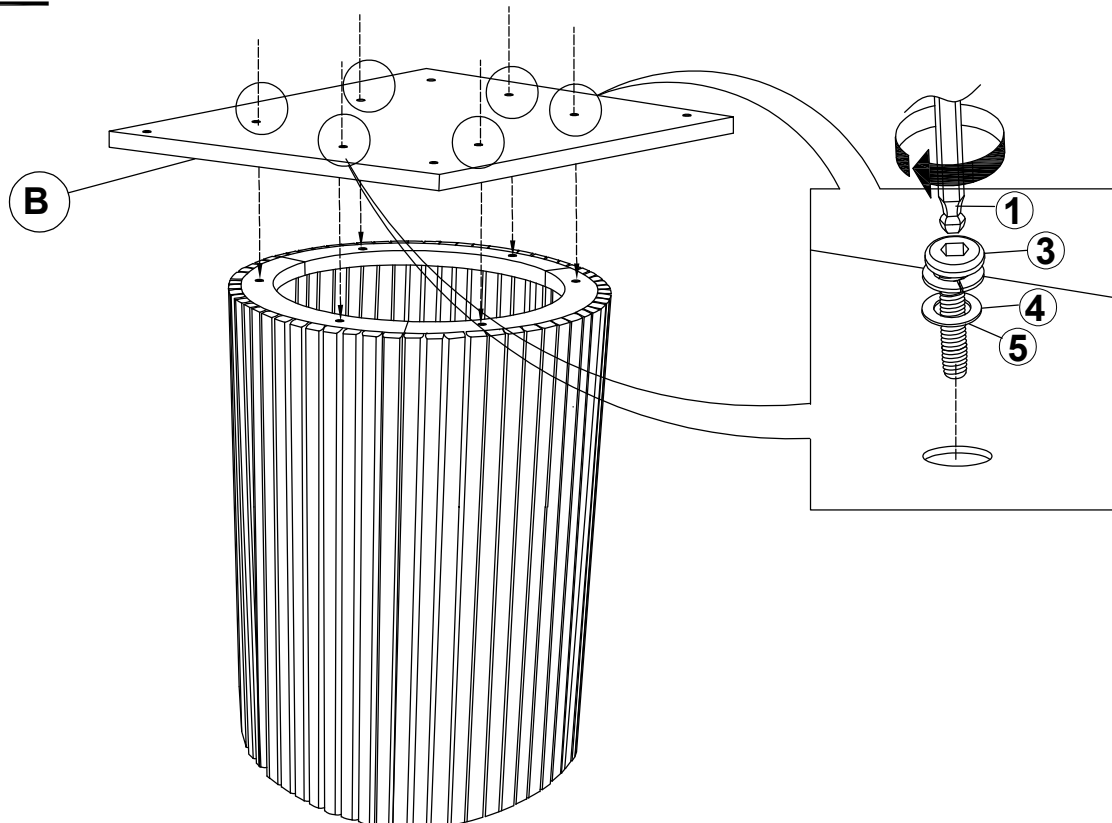

ITEM: **193930BLK**
ASSEMBLY INSTRUCTIONS



STEP 5

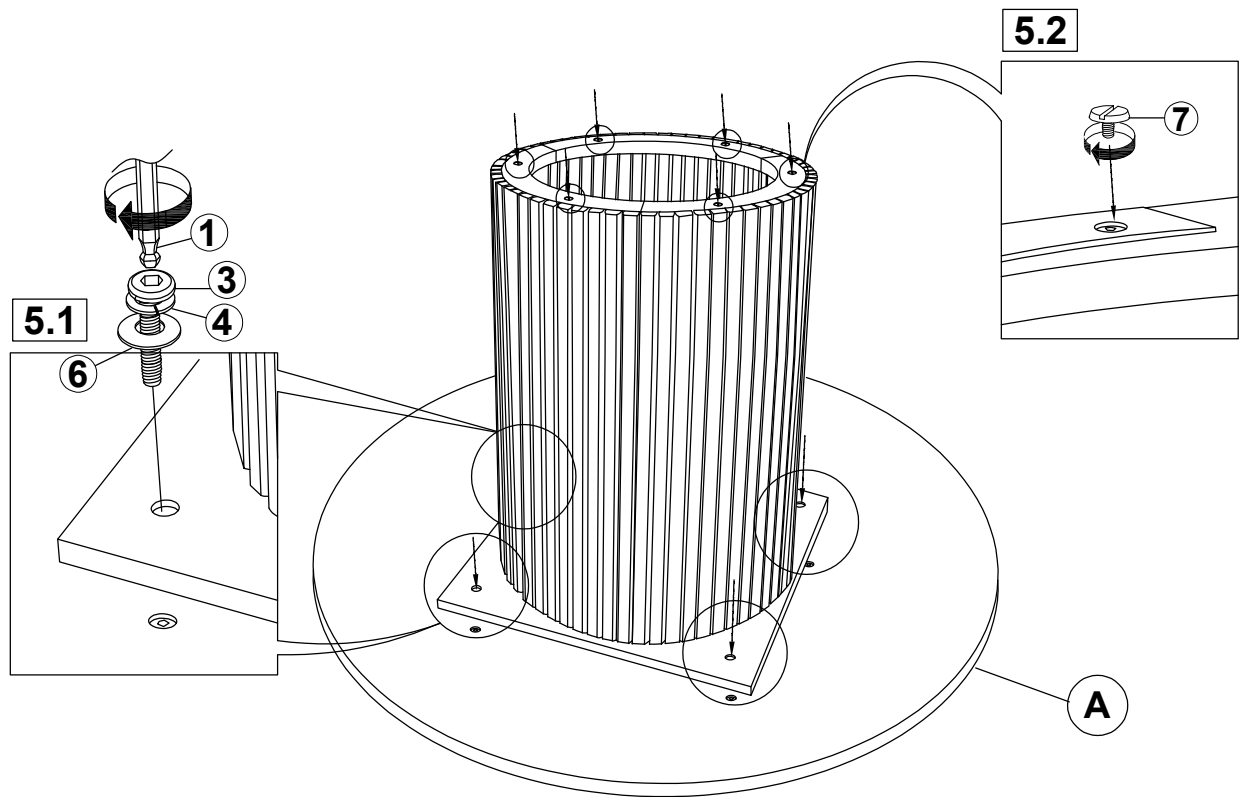

STEP 6
COMPLETE

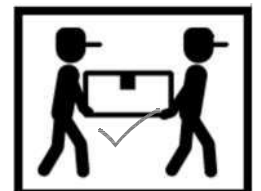
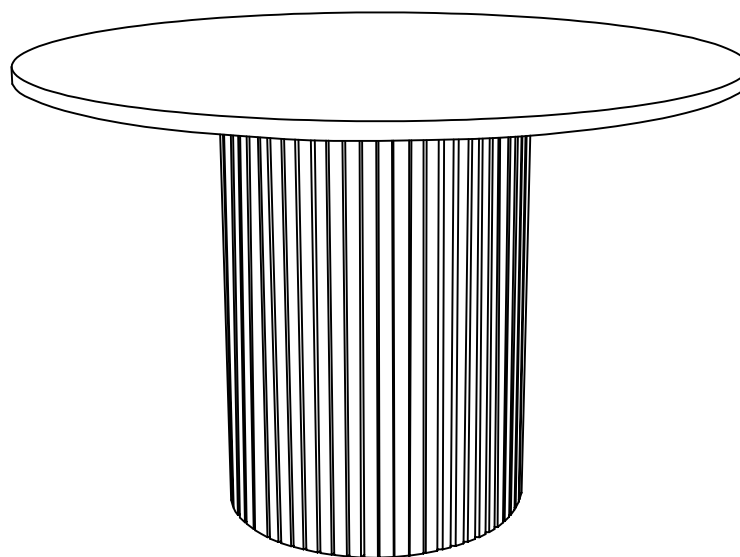

ITEM: **193930BLK**

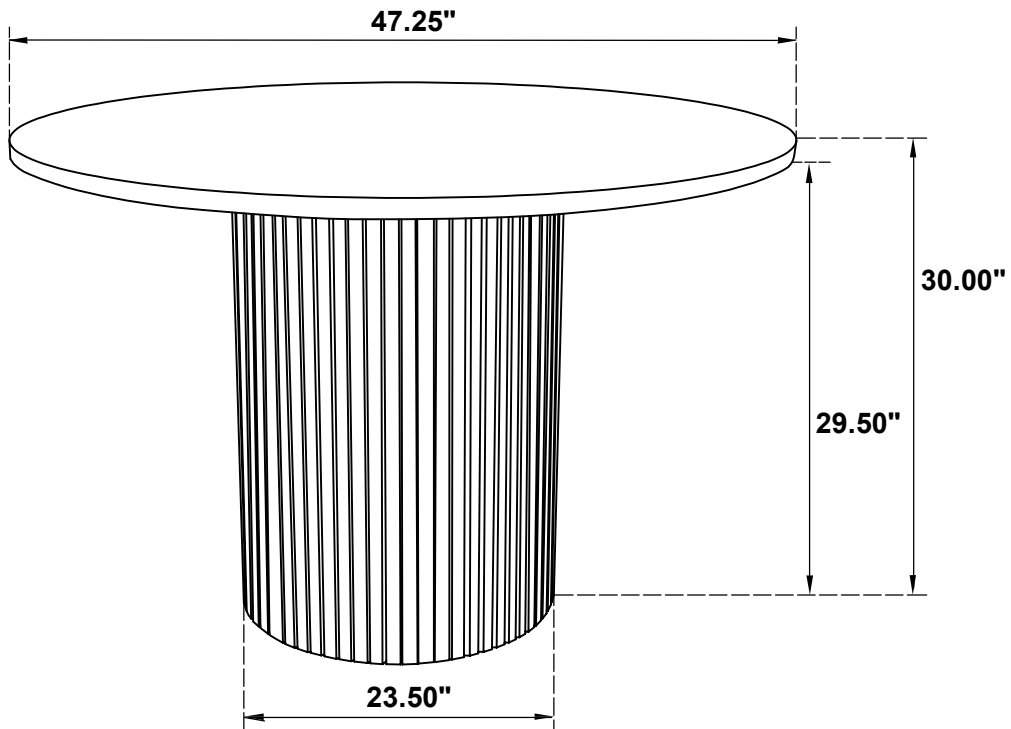

Note: Dimension tolerance $\pm 5\%$

ASSEMBLY INSTRUCTIONS
COASTER FINE FURNITURE



Fine Furniture for every stage of life

193932BLK
Side Chair

ITEM: 193932BLK



ASSEMBLY INSTRUCTIONS

ASSEMBLY TIPS:

1. Remove hardware from box and sort by size.
2. Please check to see that all hardware and parts are present prior to start of assembly.
3. Please follow attached instructions in the same sequence as numbered to assure fast & easy assembly.



WARNING!

1. Don't attempt to repair or modify parts that are broken or defective. Please contact the store immediately.
2. This product is for home use only and not intended for commercial establishments.



ASSEMBLY TIME

15 MINUTES

PARTS IDENTIFICATION

A RIGHT LEG FRAME

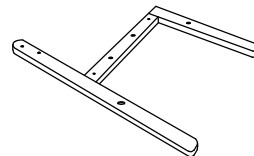

1PC

B LEFT LEG FRAME

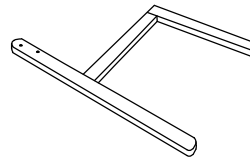

1PC

C SEAT CUSHION WITH FRAME

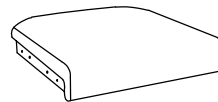

1PC

D BACKREST



1PC

E FRONT AND BACK
LOWER RAIL



2PCS

NOTE :

Quantities shown are for one chair.

ITEM: 193932BLK



ASSEMBLY INSTRUCTIONS

ASSEMBLY TIPS:







1. Remove hardware from box and sort by size.
2. Please check to see that all hardware and parts are present prior to start of assembly.
3. Please follow attached instructions in the same sequence as numbered to assure fast & easy assembly.

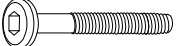
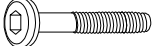

WARNING!

1. Don't attempt to repair or modify parts that are broken or defective. Please contact the store immediately.
2. This product is for home use only and not intended for commercial establishments.

HARDWARE IDENTIFICATION

1	ALLEN WRENCH (M4 x 100mm - BLK)		1PC
2	LONG BOLT (M6 x 50mm - RBW)		4PCS
3	SHORT BOLT (M6 x 40mm - RBW)		4PCS
4	LOCK WASHER (1/4" - BLK)		8PCS
5	SMALL FLAT WASHER (M6 x 13mm - RBW)		4PCS
6	BIG FLAT WASHER (1/4" - RBW)		4PCS
7	WOOD DOWEL (M10 x 30mm)		4PCS
8	PAN HEAD SCREW (#8 x 1 1/4" - BLK)		4PCS
9	WOOD PLUG (Ø14.5 x 9mm)		4PCS

NOTE :

Phillips head screw driver is required in the assembly process ; However, manufacturer does not provide this item.
Quantities shown are for one chair.

ITEM: **193932BLK**



ASSEMBLY INSTRUCTIONS

STEP 1

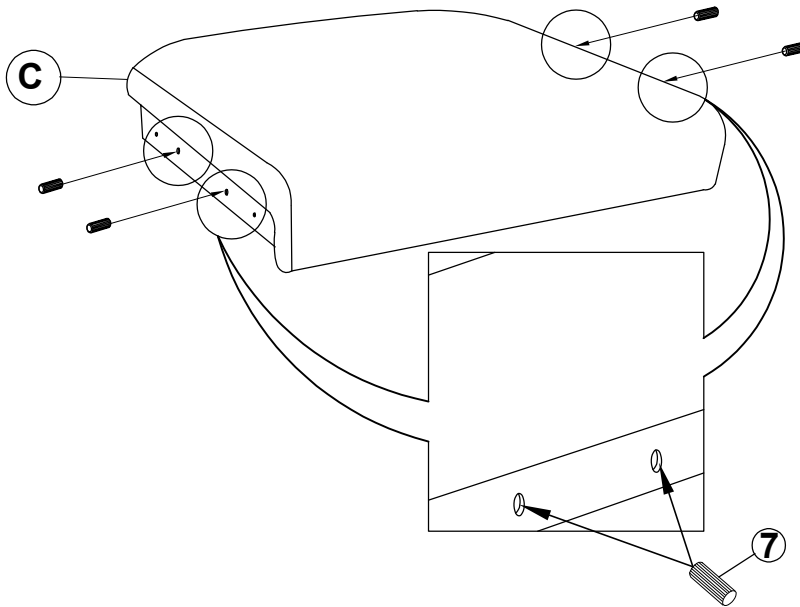

STEP 2

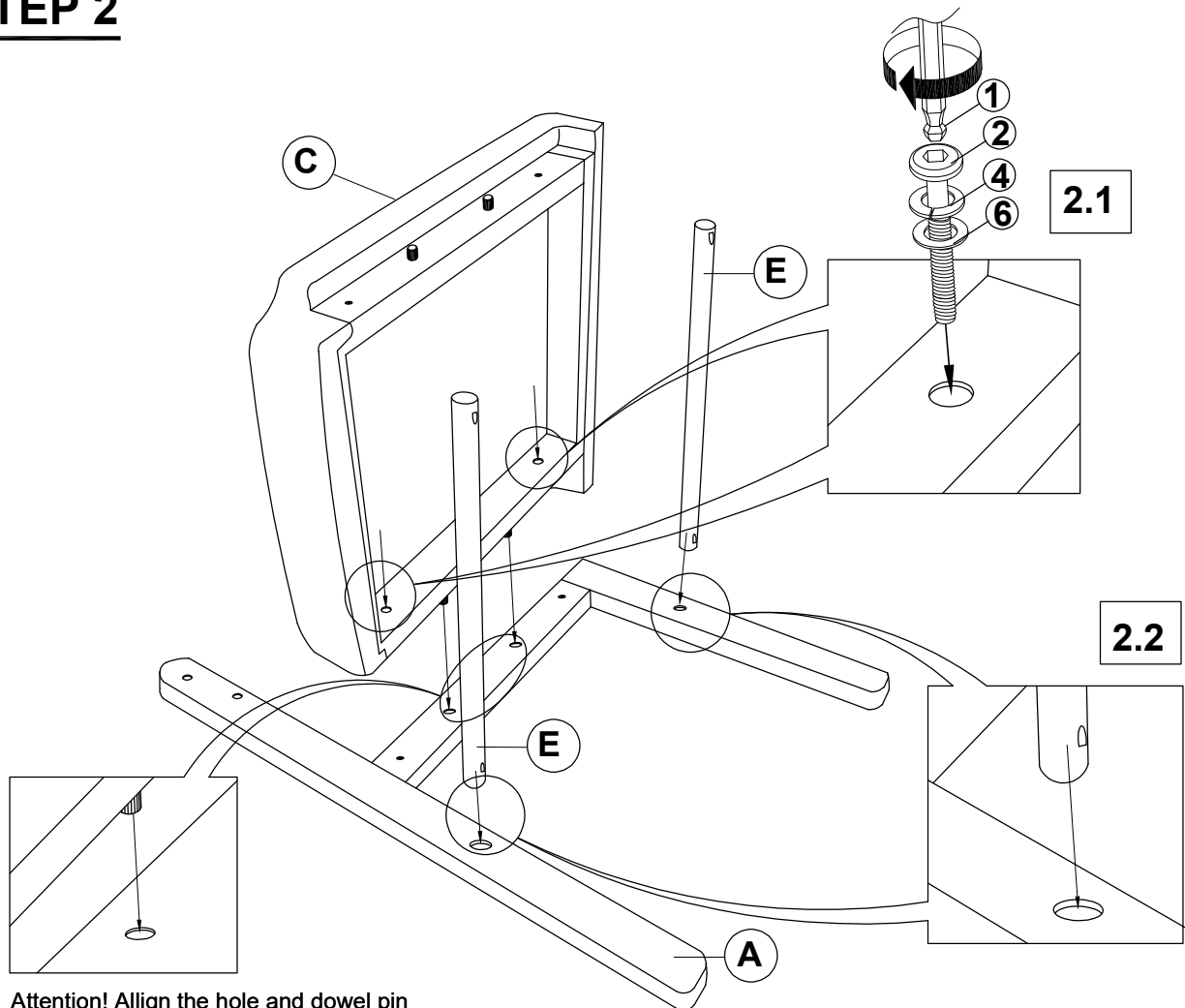

Attention! Align the hole and dowel pin before assembly

ITEM: **193932BLK**



ASSEMBLY INSTRUCTIONS

STEP 3

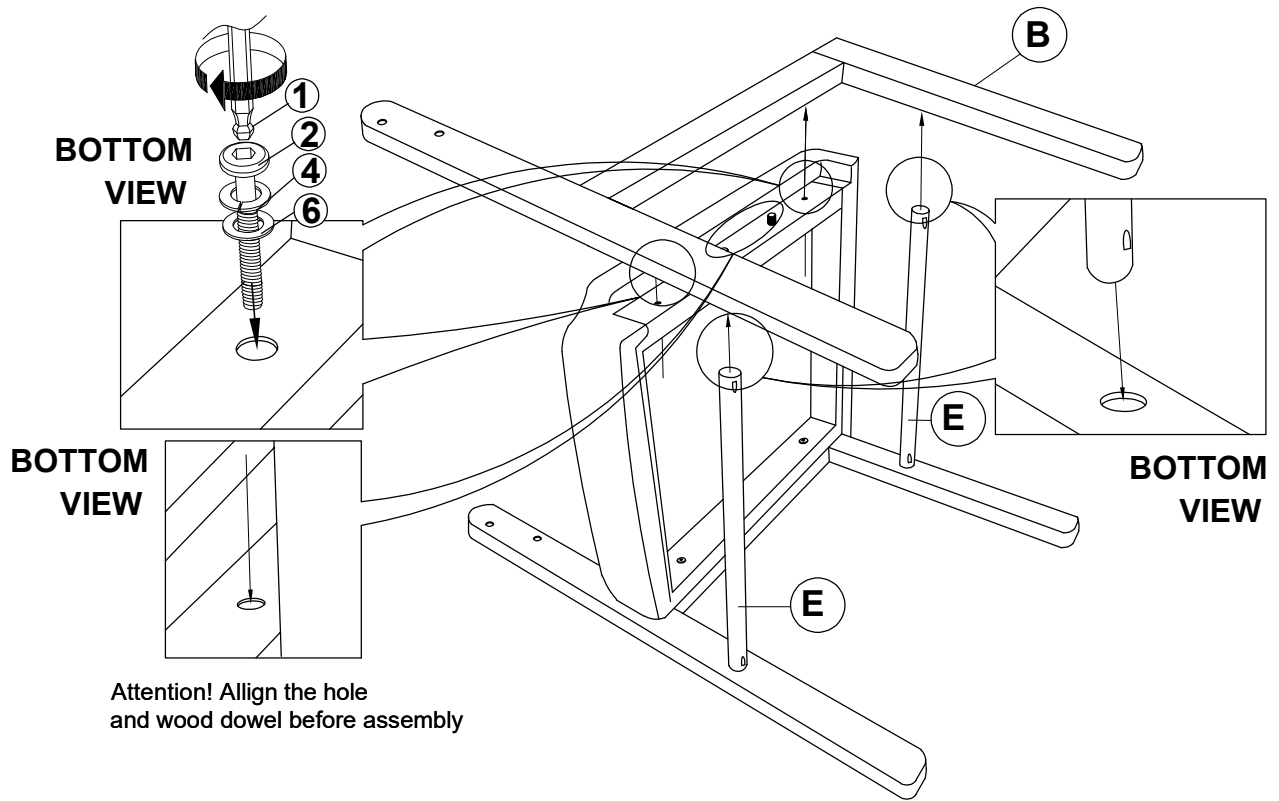

STEP 4

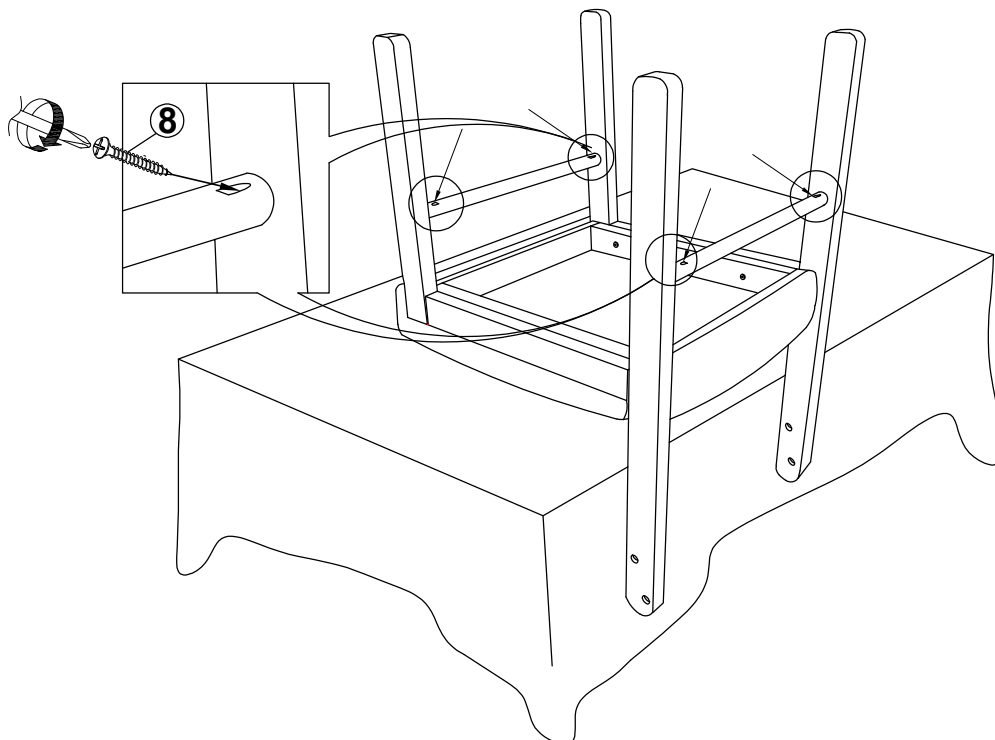

ITEM: **193932BLK**



ASSEMBLY INSTRUCTIONS

STEP 5

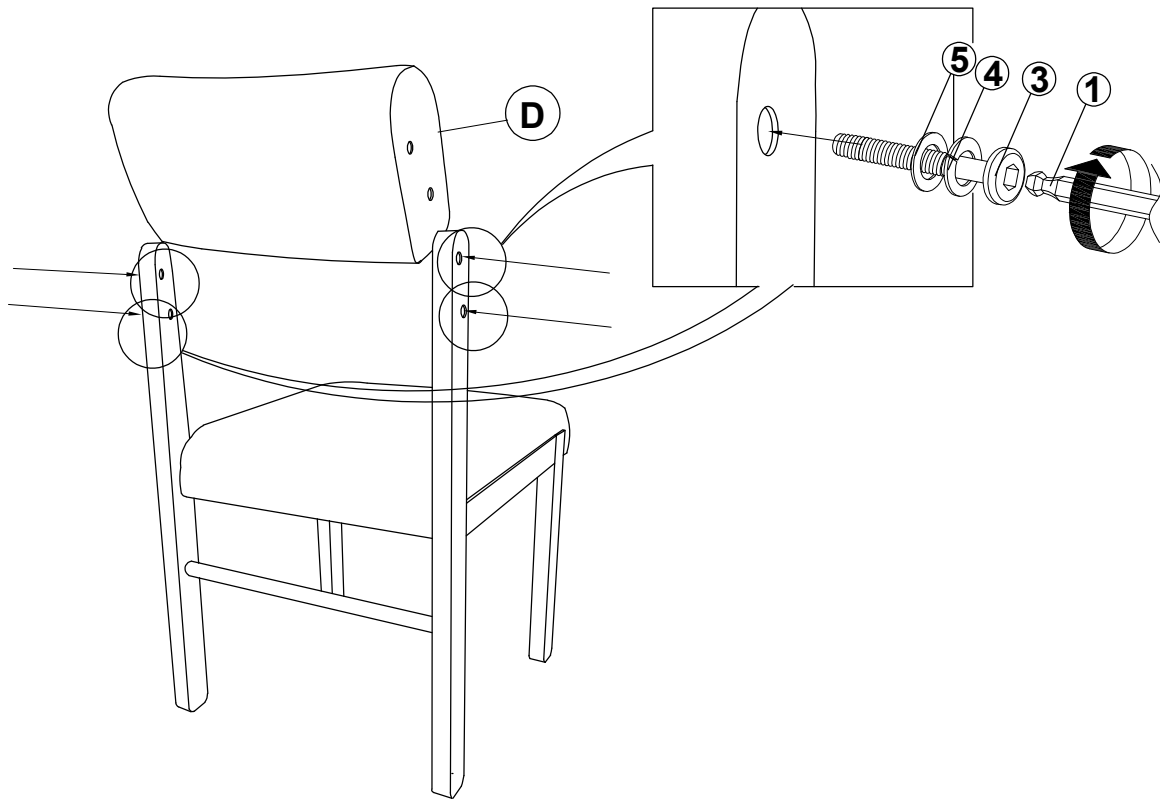

STEP 6

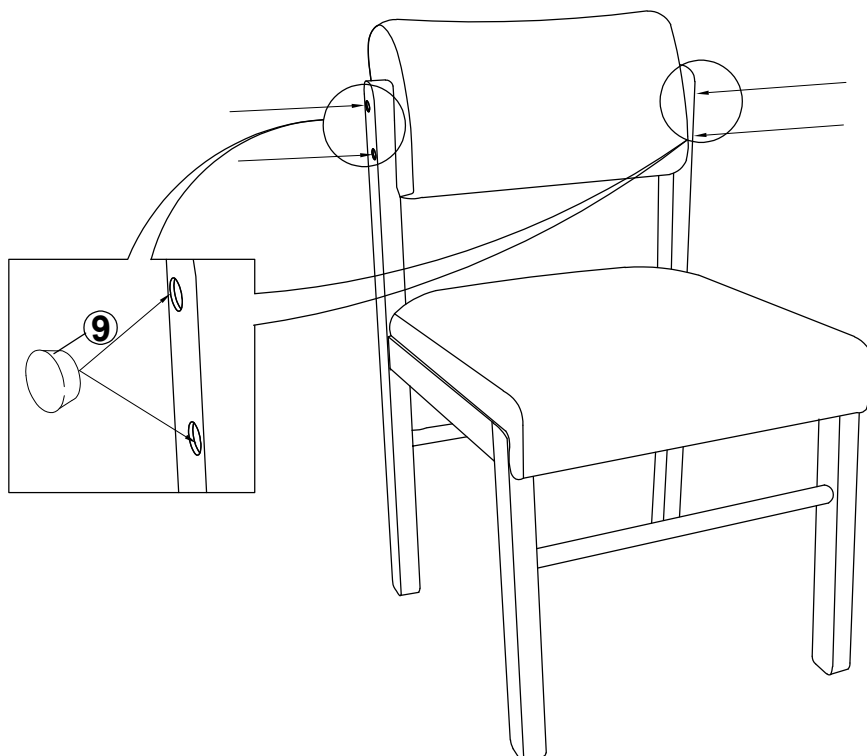

ITEM: **193932BLK**



ASSEMBLY INSTRUCTIONS

STEP 7

COMPLETE

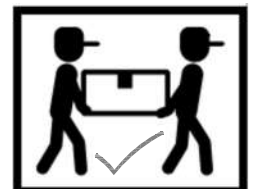
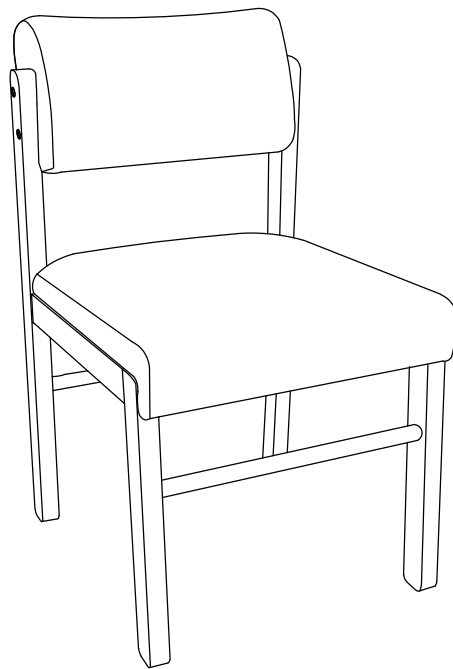

ITEM: **193932BLK**

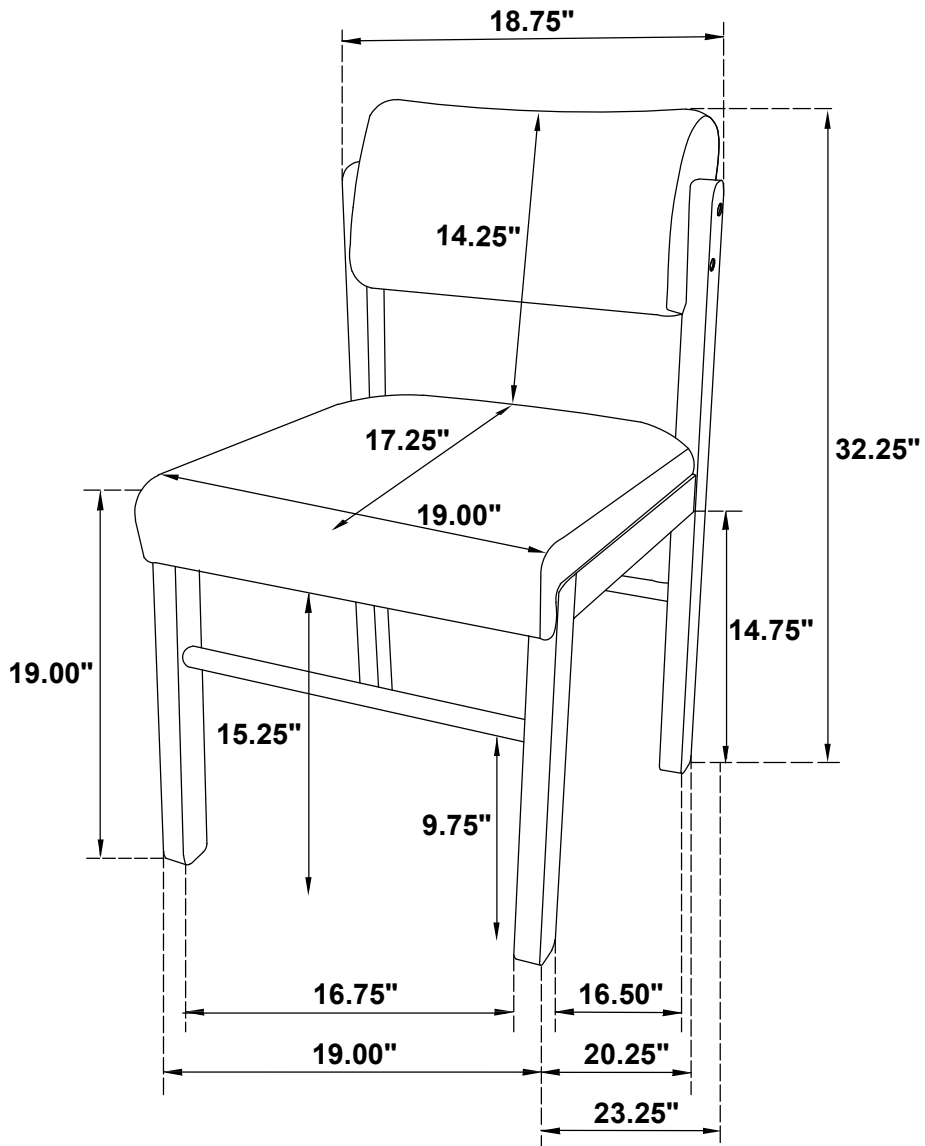

Note: Dimension tolerance $\pm 5\%$