

ASSEMBLY INSTRUCTIONS
COASTER FINE FURNITURE



Fine Furniture for every stage of life

193940NAT
Dining Table

ITEM: 193940NAT

ASSEMBLY INSTRUCTIONS



ASSEMBLY TIPS:

1. Remove hardware from box and sort by size.
2. Please check to see that all hardware and parts are present prior to start of assembly.
3. Please follow attached instructions in the same sequence as numbered to assure fast & easy assembly.



WARNING!

1. Don't attempt to repair or modify parts that are broken or defective. Please contact the store immediately.
2. This product is for home use only and not intended for commercial establishments.





ASSEMBLY TIME

15 MINUTES

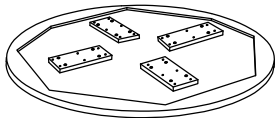
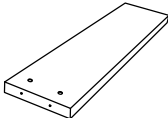
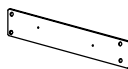
PARTS IDENTIFICATION

A	TOP		1PC
B	LEG		4PCS
C	MOUNTING BAR		4PCS

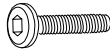
HARDWARE IDENTIFICATION

1	LONG ALLEN WRENCH (M5 x 95mm - BLK)		1PC
2	SHORT ALLEN WRENCH (M4 x 63mm - BLK)		1PC
3	HEX BOLT (M8 x 60mm - ZB)		8PCS
4	BOLT (M6 x 30mm - RBW)		16PCS
5	LOCK WASHER (1/4" - BLK)		16PCS
6	BARREL NUT (M8 x 12 x 18mm - ZB)		8PCS
7	WOOD PLUG (Ø14.5 x 9mm)		8PCS
8	LEVELER (M6 x 14.8mm)		4PCS

ITEM: 193940NAT

ASSEMBLY INSTRUCTIONS



STEP 1

Attention! Align the correction position for mounting bar before assembly

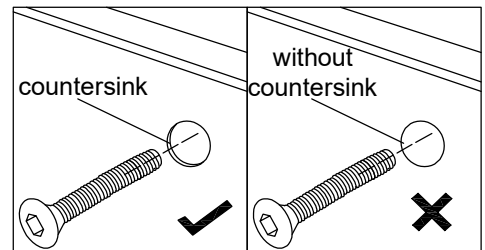
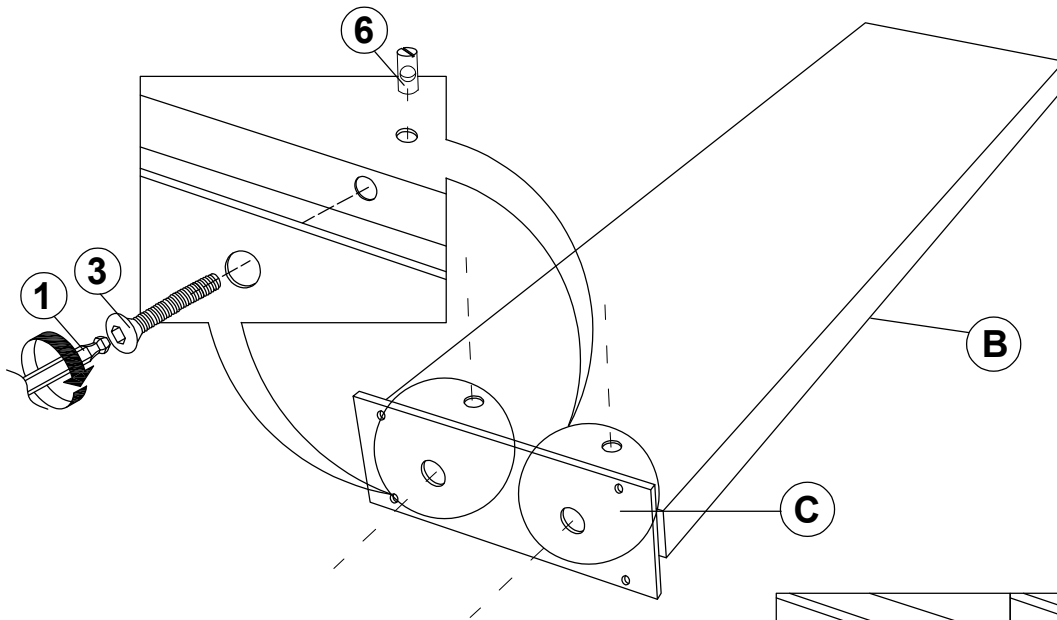

STEP 2

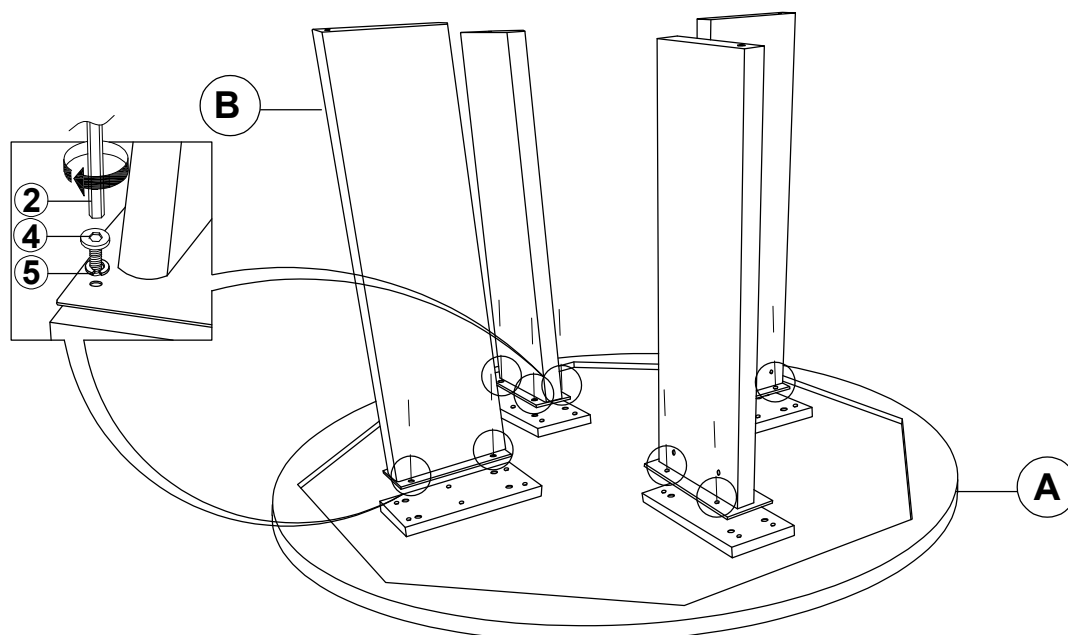

ITEM: **193940NAT**
ASSEMBLY INSTRUCTIONS



STEP 3

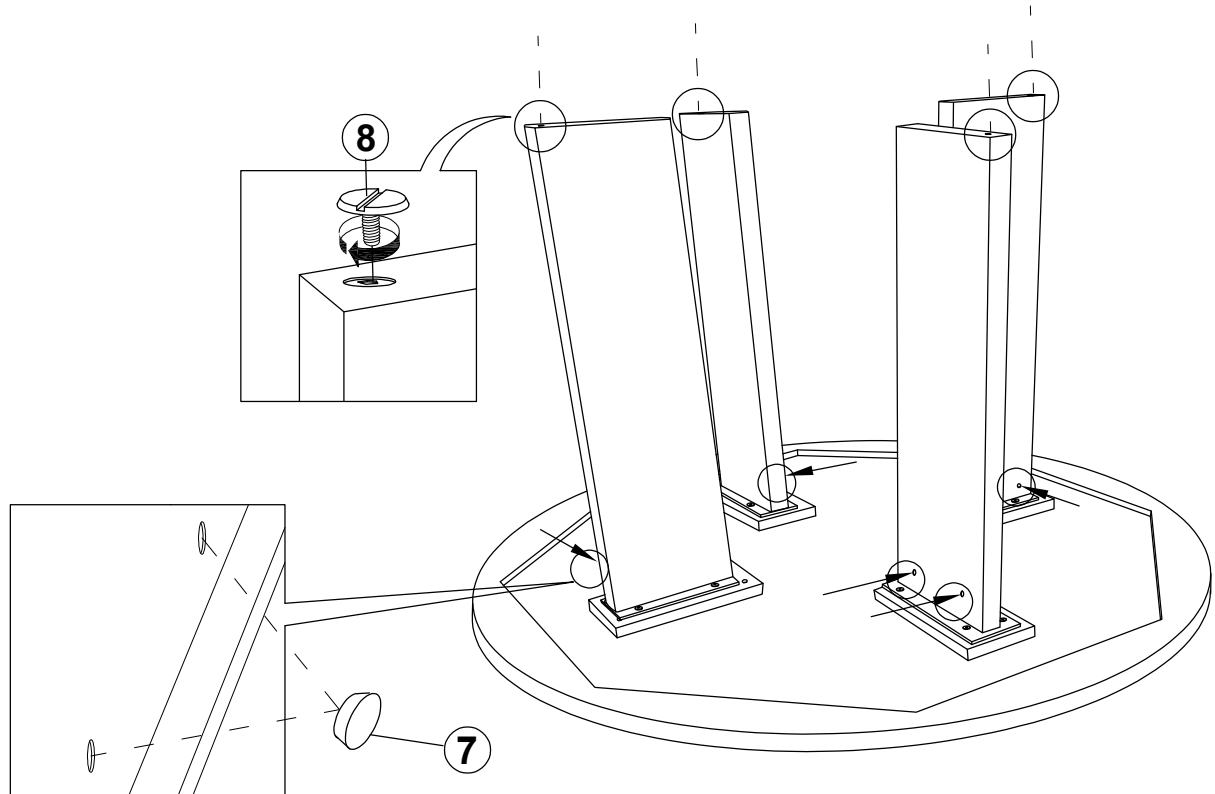

STEP 4
COMPLETE

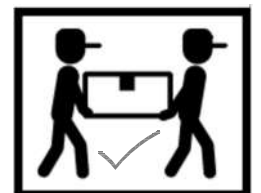
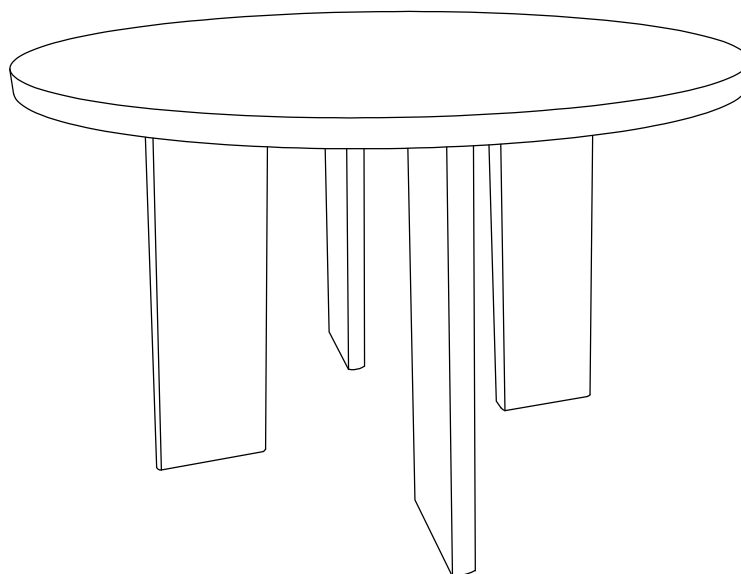

ITEM: **193940NAT**

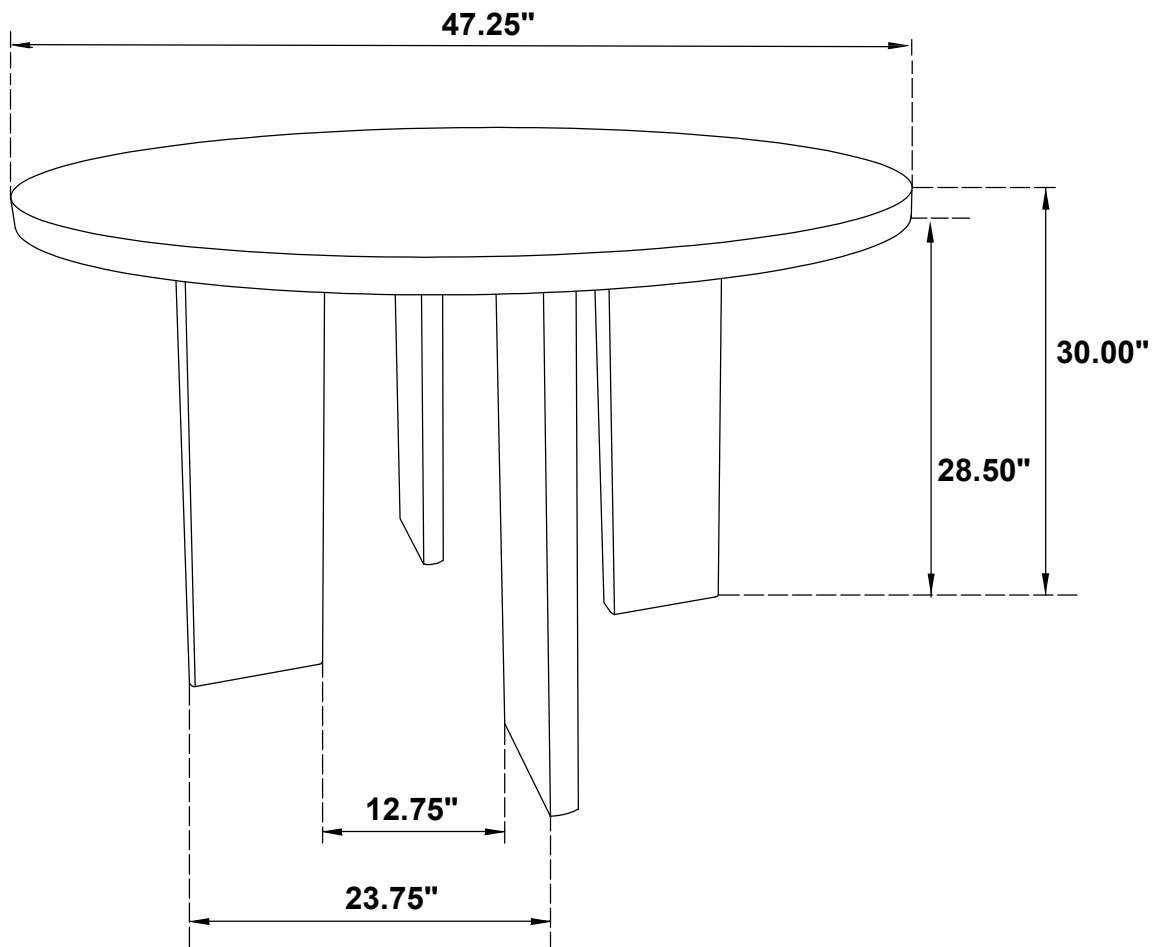

Note: Dimension tolerance $\pm 5\%$

ASSEMBLY INSTRUCTIONS
COASTER FINE FURNITURE



Fine Furniture for every stage of life

193922NAT
Side Chair

ITEM: 193922NAT



ASSEMBLY INSTRUCTIONS

ASSEMBLY TIPS:

1. Remove hardware from box and sort by size.
2. Please check to see that all hardware and parts are present prior to start of assembly.
3. Please follow attached instructions in the same sequence as numbered to assure fast & easy assembly.



WARNING!

1. Don't attempt to repair or modify parts that are broken or defective. Please contact the store immediately.
2. This product is for home use only and not intended for commercial establishments.



ASSEMBLY TIME

15 MINUTES

PARTS IDENTIFICATION

A RIGHT LEG FRAME

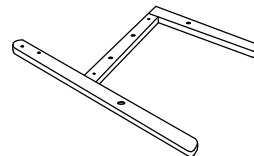

1PC

B LEFT LEG FRAME

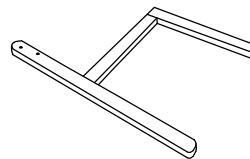

1PC

C SEAT CUSHION WITH FRAME

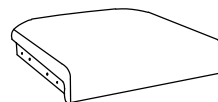

1PC

D BACKREST



1PC

E FRONT AND BACK
LOWER RAIL



2PCS

NOTE :

Quantities shown are for one chair.

ITEM : 193922NAT



ASSEMBLY INSTRUCTIONS

ASSEMBLY TIPS:







1. Remove hardware from box and sort by size.
2. Please check to see that all hardware and parts are present prior to start of assembly.
3. Please follow attached instructions in the same sequence as numbered to assure fast & easy assembly.

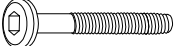
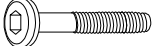

WARNING!

1. Don't attempt to repair or modify parts that are broken or defective. Please contact the store immediately.
2. This product is for home use only and not intended for commercial establishments.

HARDWARE IDENTIFICATION

1	ALLEN WRENCH (M4 x 100mm - BLK)		1PC
2	LONG BOLT (M6 x 50mm - RBW)		4PCS
3	SHORT BOLT (M6 x 40mm - RBW)		4PCS
4	LOCK WASHER (1/4" - BLK)		8PCS
5	SMALL FLAT WASHER (M6 x 13mm - RBW)		4PCS
6	BIG FLAT WASHER (1/4" - RBW)		4PCS
7	WOOD DOWEL (M10 x 30mm)		4PCS
8	PAN HEAD SCREW (#8 x 1 1/4" - BLK)		4PCS
9	WOOD PLUG (Ø14.5 x 9mm)		4PCS

NOTE :

Phillips head screw driver is required in the assembly process ; However, manufacturer does not provide this item.
Quantities shown are for one chair.

ITEM: 193922NAT

ASSEMBLY INSTRUCTIONS

STEP 1

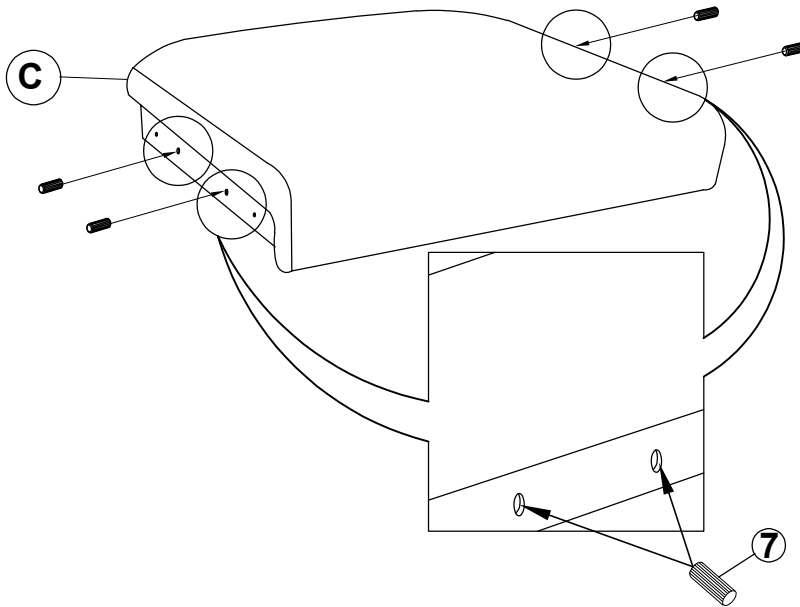

STEP 2

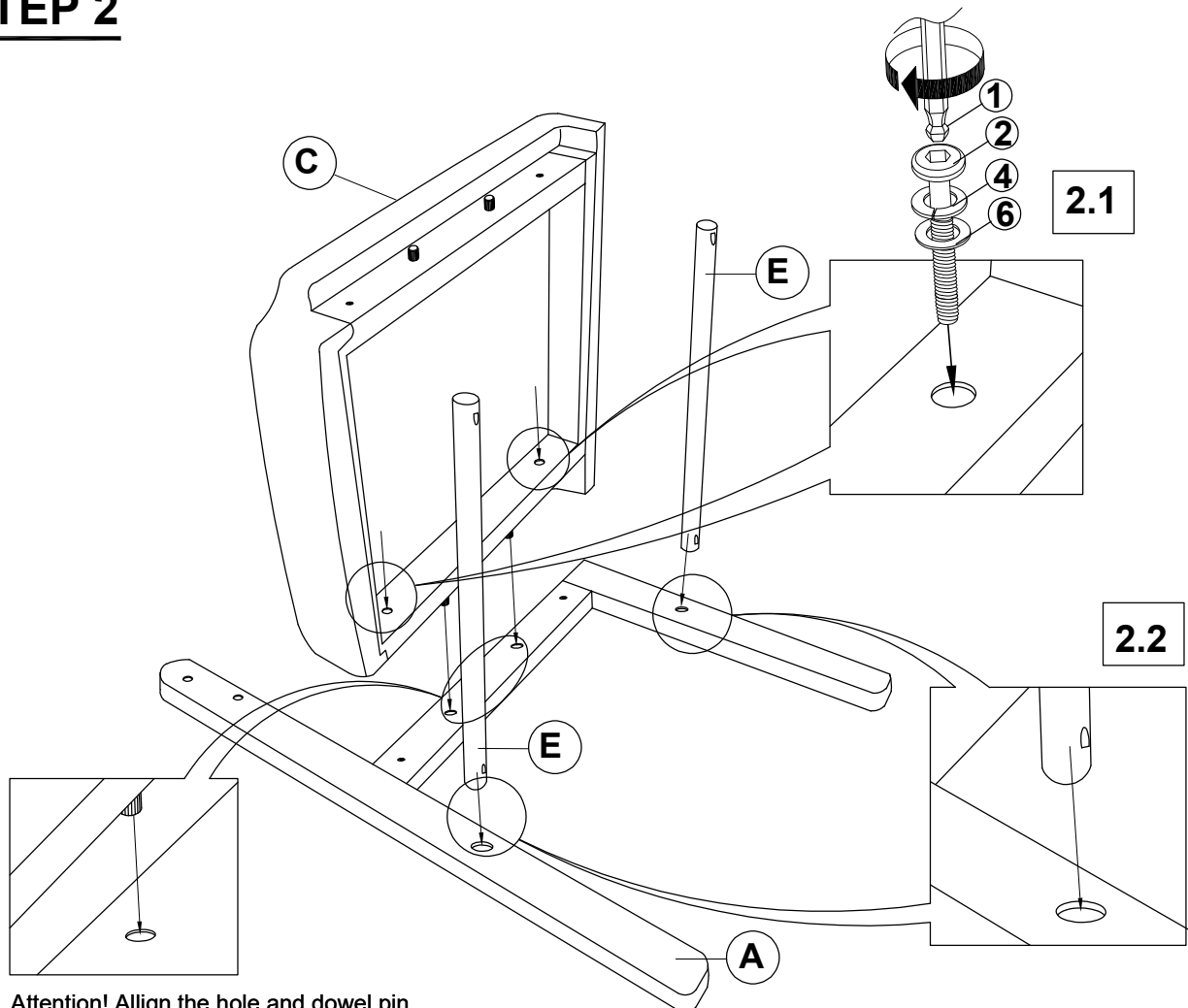

Attention! Align the hole and dowel pin before assembly

ITEM: 193922NAT



ASSEMBLY INSTRUCTIONS

STEP 3

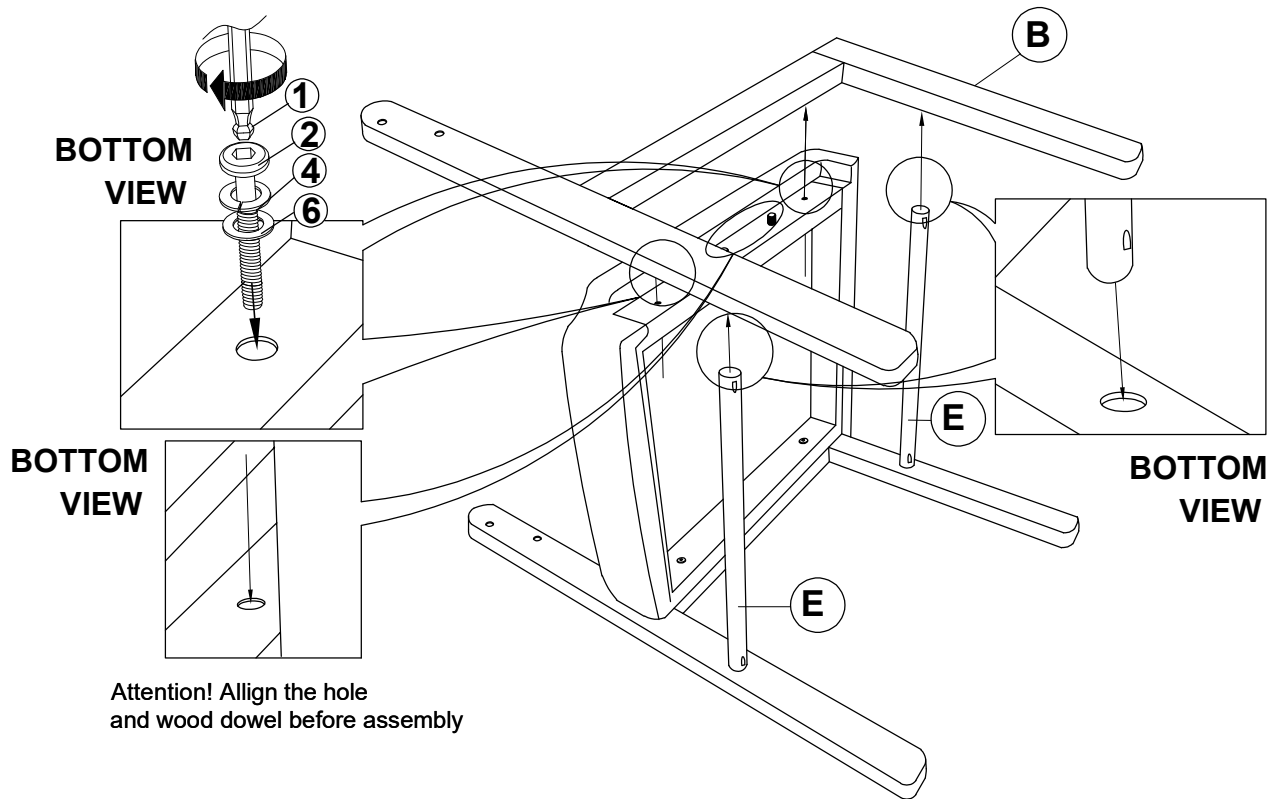

STEP 4

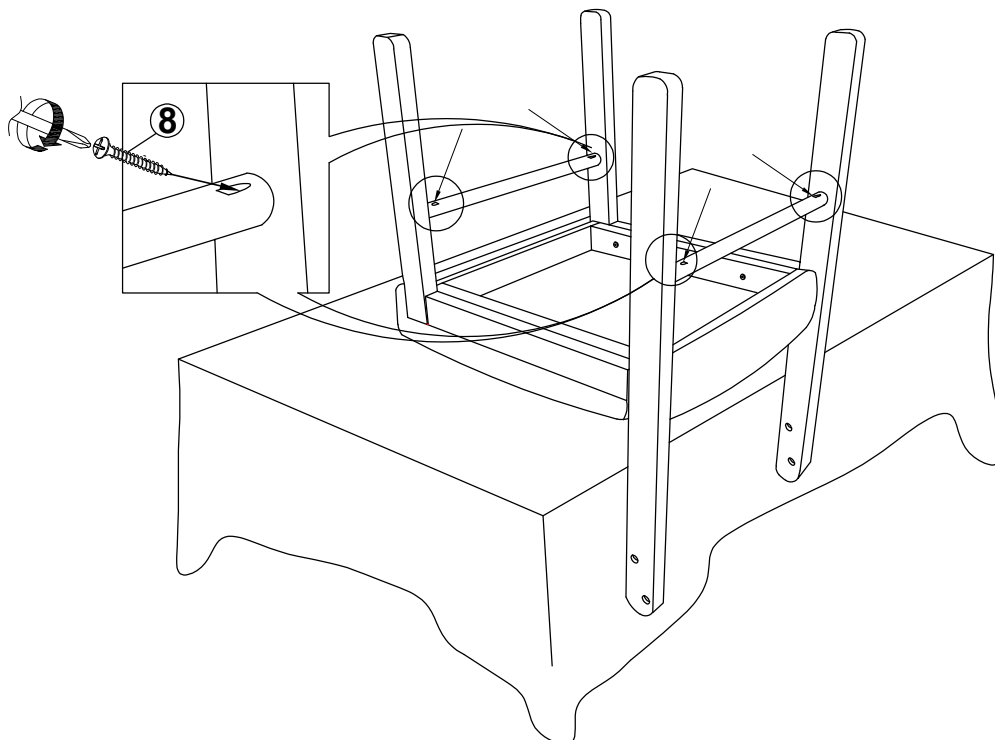

ITEM: **193922NAT**



ASSEMBLY INSTRUCTIONS

STEP 5

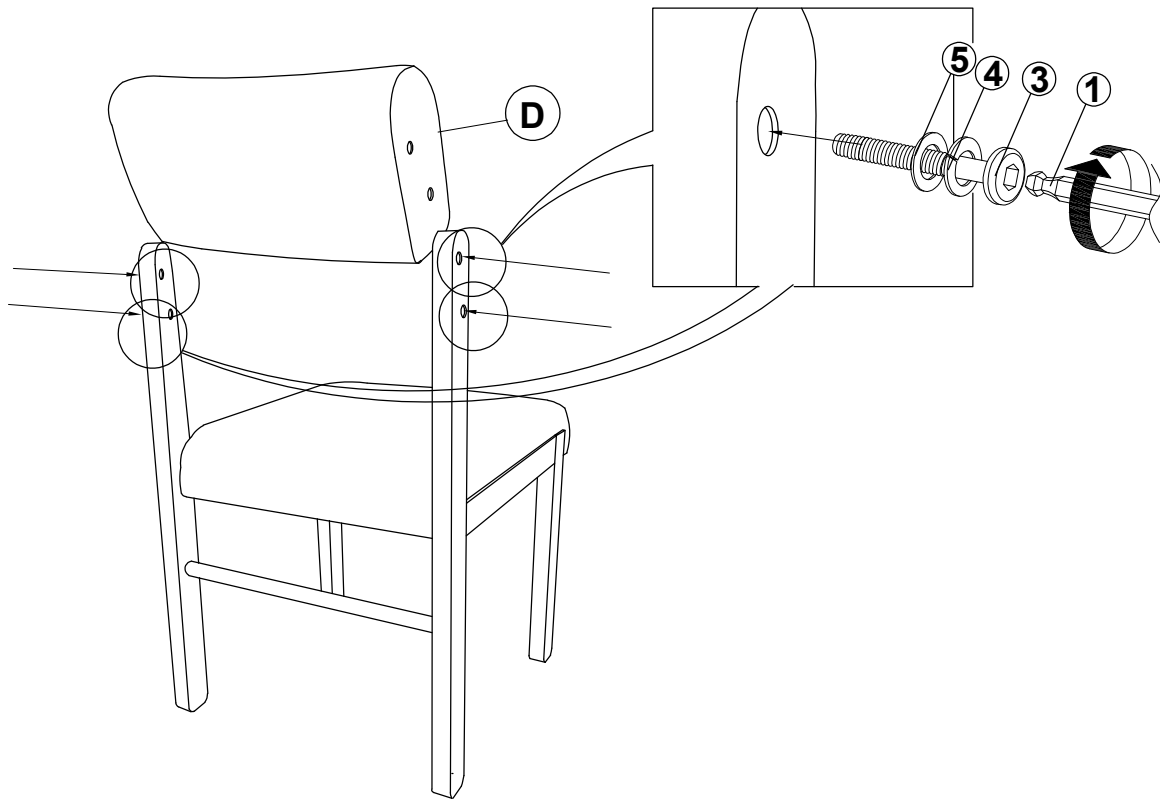

STEP 6

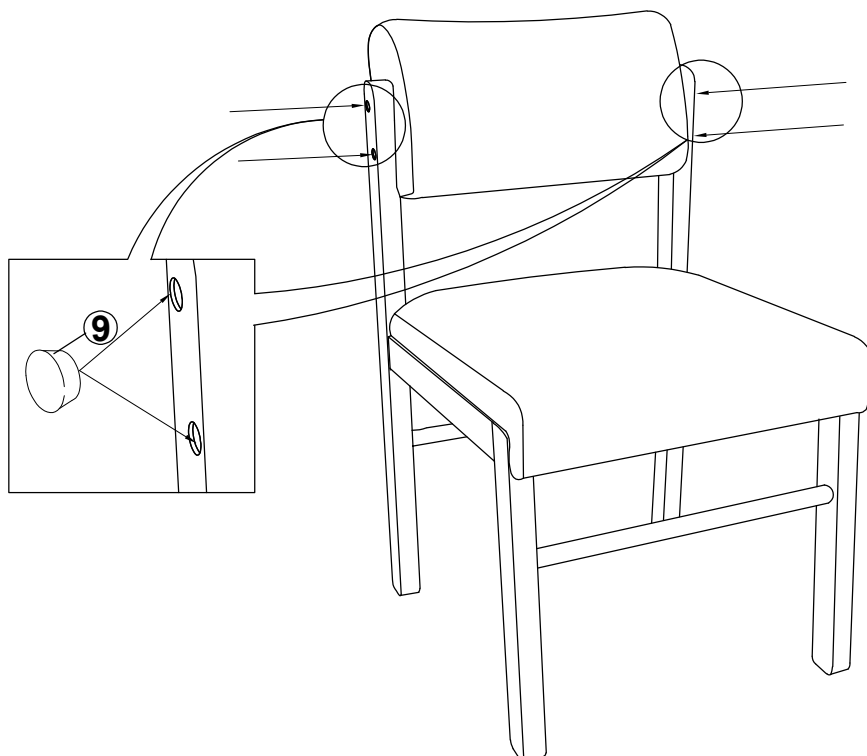

ITEM: **193922NAT**



ASSEMBLY INSTRUCTIONS

STEP 7

COMPLETE

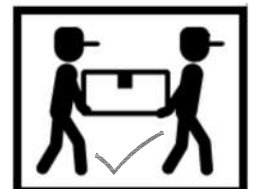
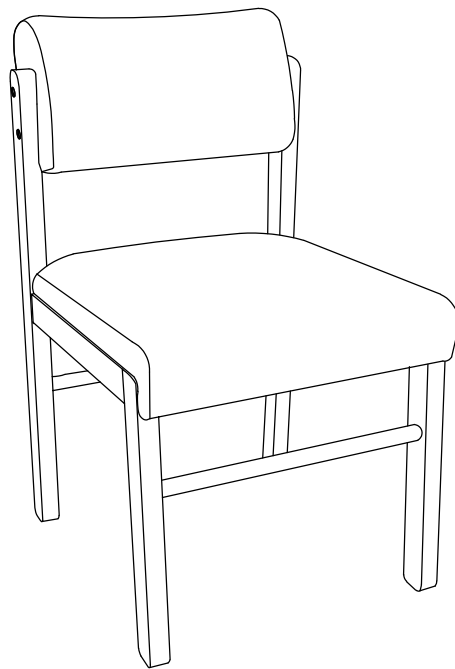

ITEM: **193922NAT**

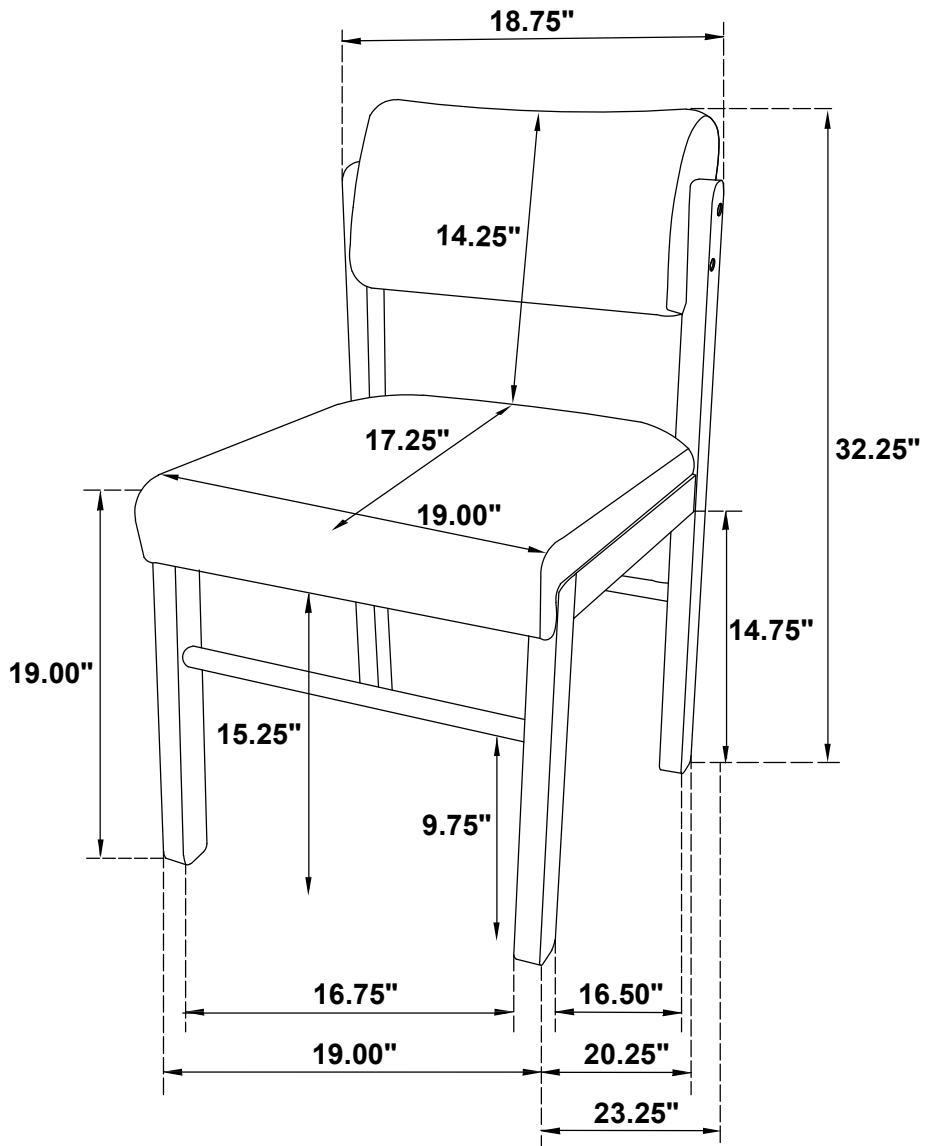

Note: Dimension tolerance $\pm 5\%$