



*ASSEMBLY INSTRUCTIONS
COASTER FINE FURNITURE*



Fine Furniture for every stage of life

509879
Sectional

ITEM: 509879B1

ASSEMBLY INSTRUCTIONS



ASSEMBLY TIPS:

1. Remove hardware from box and sort by size.
2. Please check to see that all hardware and parts are present prior to start of assembly.
3. Please follow attached instructions in the same sequence as numbered to assure fast & easy assembly.



WARNING!



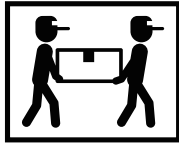



1. Don't attempt to repair or modify parts that are broken or defective. Please contact the store immediately.
2. This product is for home use only and not intended for commercial establishments.

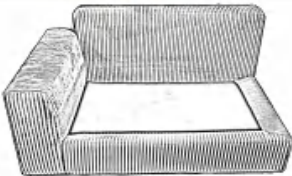

ASSEMBLY TIME

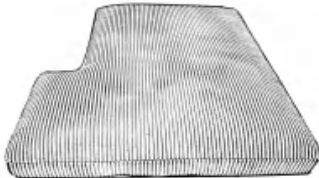
8 MINUTES

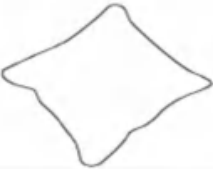
PARTS IDENTIFICATION

B1	PART NAME	FIGURE	QUANTITY
A	LAF LOVESEAT BASE		1PC
B	CHAISE BASE		1PC
C	CHAISE SEAT CUSHION		1PC
D	LOVESEAT BACK CUSHION		1PC
E	PILLOW (3pcs located in B1; 3pcs located in B2)		6PCS
F	LEG		8PCS

ITEM: 509879B1



ASSEMBLY INSTRUCTIONS

STEP 1 Turn over the item and take out the legs from zippered pouch

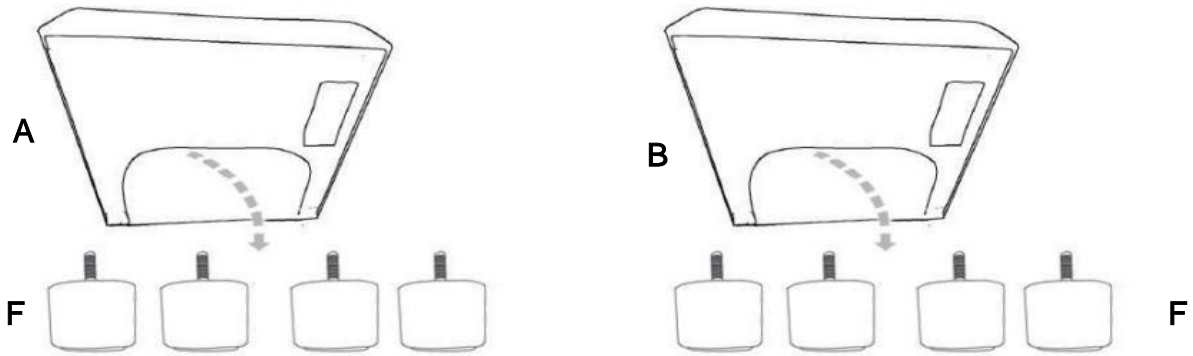

STEP 2 Install the legs as pictures show

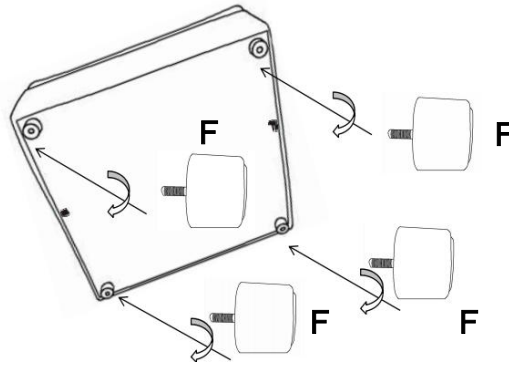

STEP 3 Please remove the wood block with screwdriver, do not use a hammer

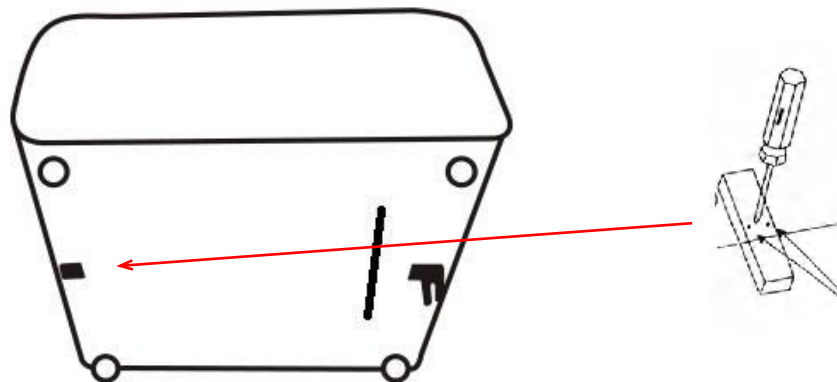

STEP 4

COMPLETE

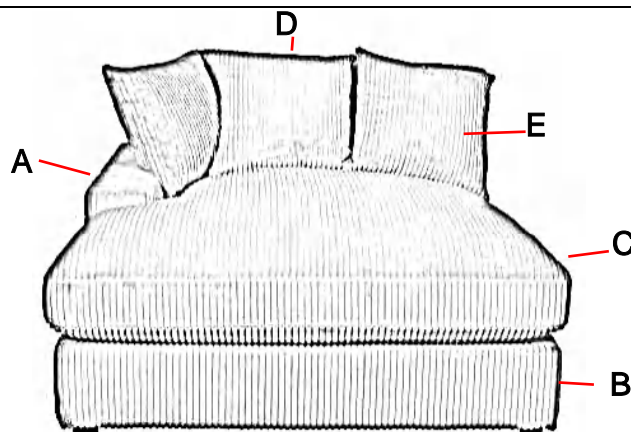

ITEM: 509879B2

ASSEMBLY INSTRUCTIONS



ASSEMBLY TIPS:

1. Remove hardware from box and sort by size.
2. Please check to see that all hardware and parts are present prior to start of assembly.
3. Please follow attached instructions in the same sequence as numbered to assure fast & easy assembly.

WARNING!



1. Don't attempt to repair or modify parts that are broken or defective. Please contact the store immediately.
2. This product is for home use only and not intended for commercial establishments.

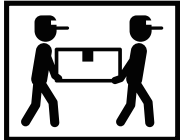

ASSEMBLY TIME

8 MINUTES

PARTS IDENTIFICATION

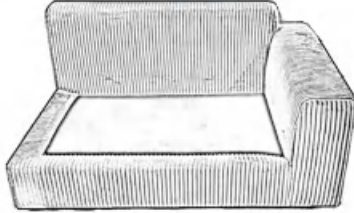
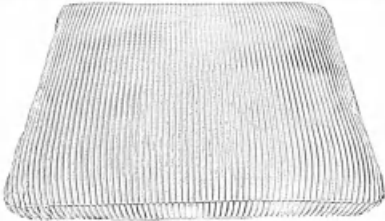
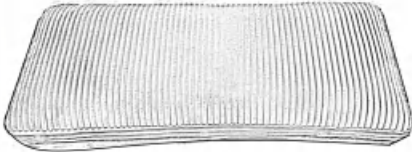
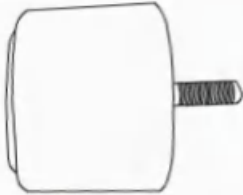
B2	PART NAME	FIGURE	QUANTITY
G	RAF LOVESEAT BASE		1PC
H	LOVESEAT SEAT CUSHION		1PC
D	LOVESEAT BACK CUSHION		1PC
F	LEG		4PCS

ITEM: 509879B2



ASSEMBLY INSTRUCTIONS

STEP 5 Turn over the item and take out the legs from zippered pouch

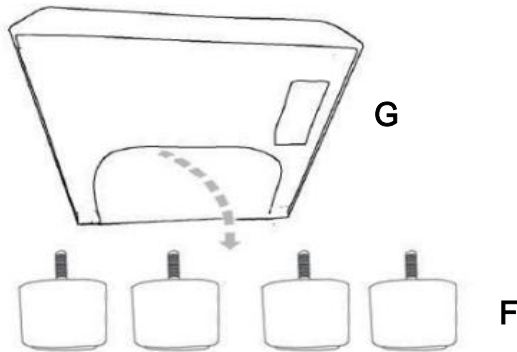

STEP 6 Install the legs as pictures show

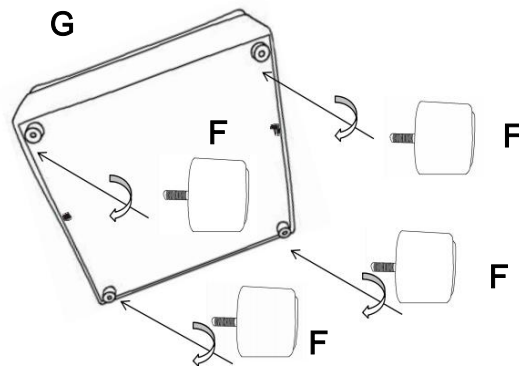

STEP 7 Please remove the wood block with screwdriver, do not use a hammer

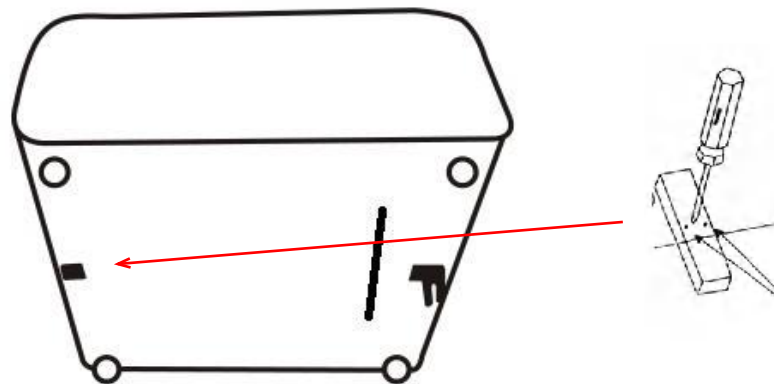

STEP 8

COMPLETE

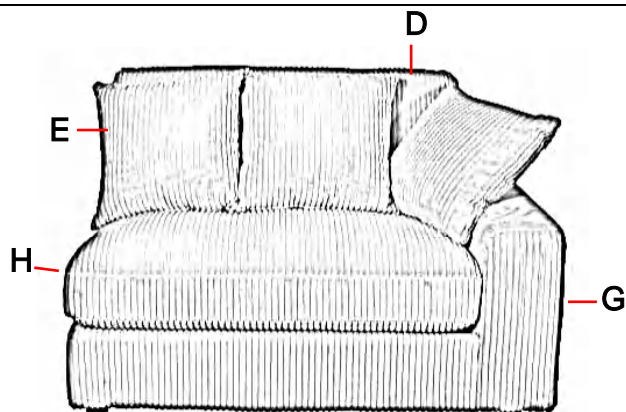

ITEM: 509879

ASSEMBLY INSTRUCTIONS



STEP 9 Rotate the metal clips

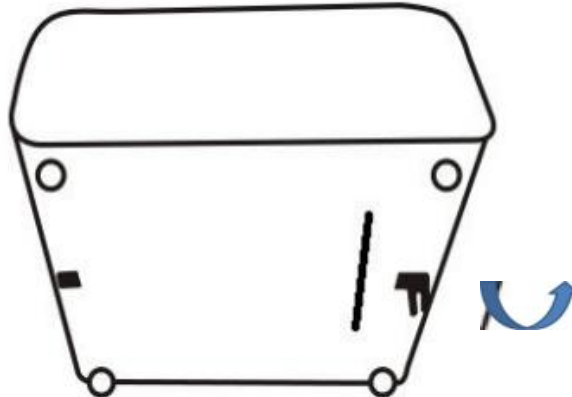

STEP 10 Put the chaise and loveseat closer
509879B1

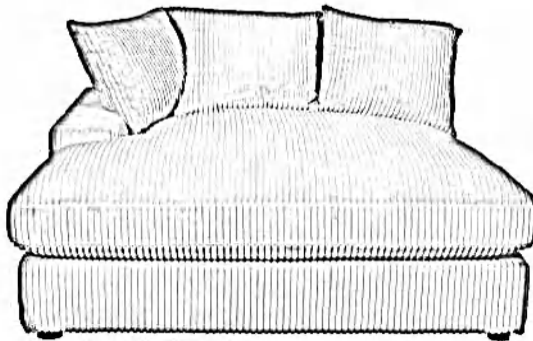

509879B2

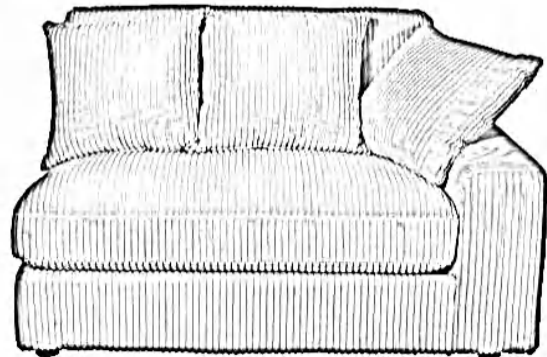

STEP 11 Insert the metal clips to connect other units as pictures show

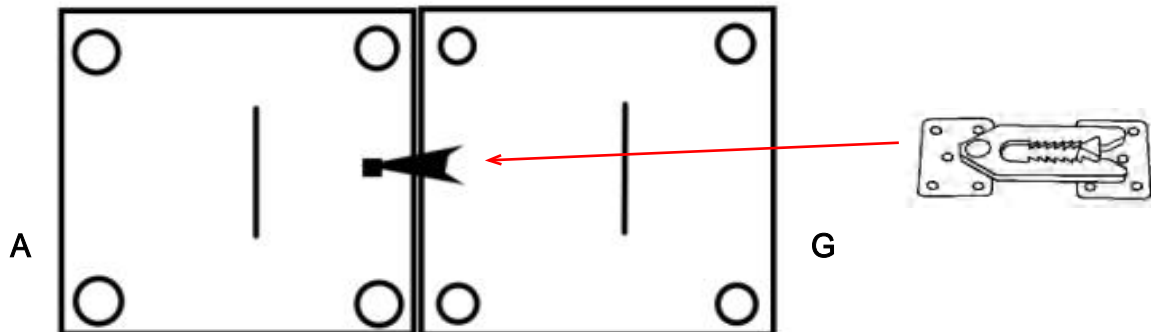

STEP 12

COMPLETE

OPTION1

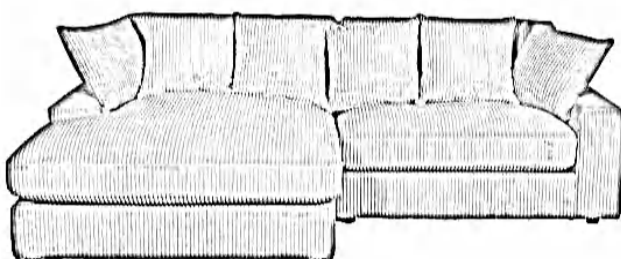

OPTION2

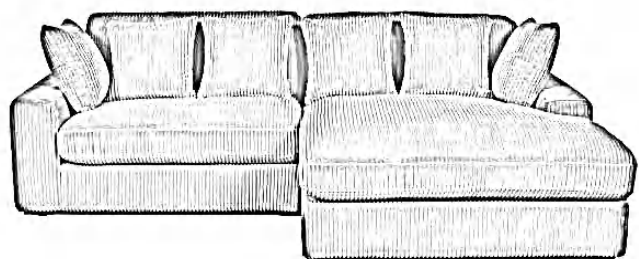

ITEM: 509879

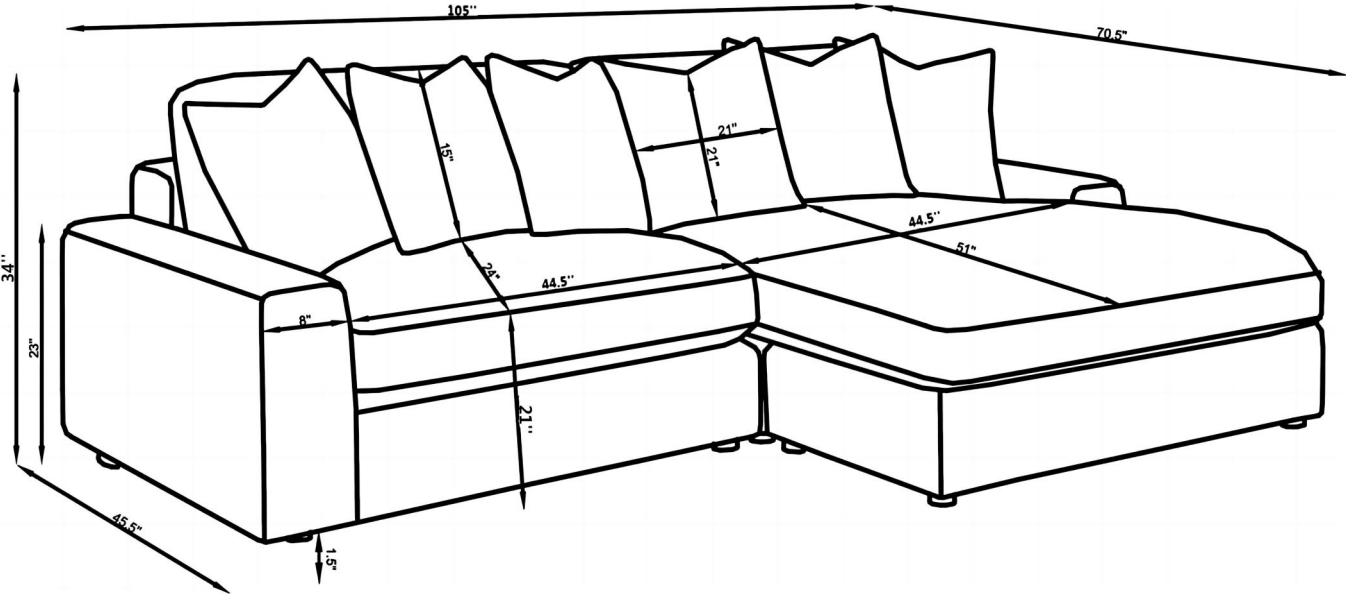

Note : Dimension tolerance $\pm 5\%$

