

ASSEMBLY INSTRUCTIONS
COASTER FINE FURNITURE



Fine Furniture for every stage of life

706477
End Table

ITEM: 706477



ASSEMBLY INSTRUCTIONS

ASSEMBLY TIPS:

1. Remove hardware from box and sort by size.
2. Please check to see that all hardware and parts are present prior to start of assembly.
3. Please follow attached instructions in the same sequence as numbered to assure fast & easy assembly.



WARNING!

1. Don't attempt to repair or modify parts that are broken or defective. Please contact the store immediately.
2. This product is for home use only and not intended for commercial establishments.



ASSEMBLY TIME

15 MINUTES

PARTS IDENTIFICATION

A	TOP		1PC
B	LEG		2PCS
C	MOUNTING BOARD		2PCS
D	CENTER SUPPORT		1PC

HARDWARE IDENTIFICATION

1	ALLEN WRENCH (M4 x 63MM - BLK)		1PC
2	LONG HEX HEAD SCREW (M7 x 50MM - RBW)		4PCS
3	SHORT HEX HEAD SCREW (M7 x 35MM - RBW)		8PCS
4	BOLT (M6 x 30MM - RBW)		8PCS
5	LOCK WASHER (1/4" - BLK)		8PCS
6	FLAT WASHER (M6 x 13MM - RBW)		8PCS
7	WOOD DOWEL (M10 x 30MM)		2PCS
8	WOOD PLUG (Ø14.5 x 9MM)		4PCS
9	LEVELER (M6 x 14.8MM)		4PCS

ITEM: **706477**

ASSEMBLY INSTRUCTIONS



STEP 1

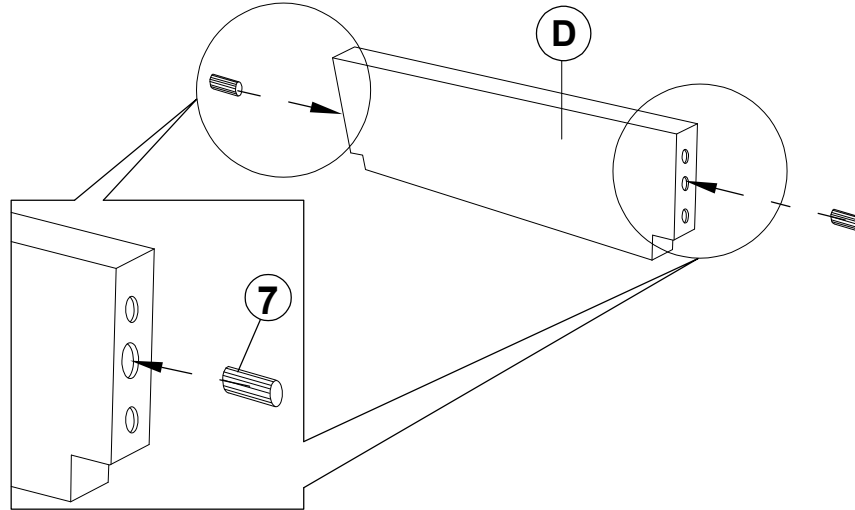

STEP 2

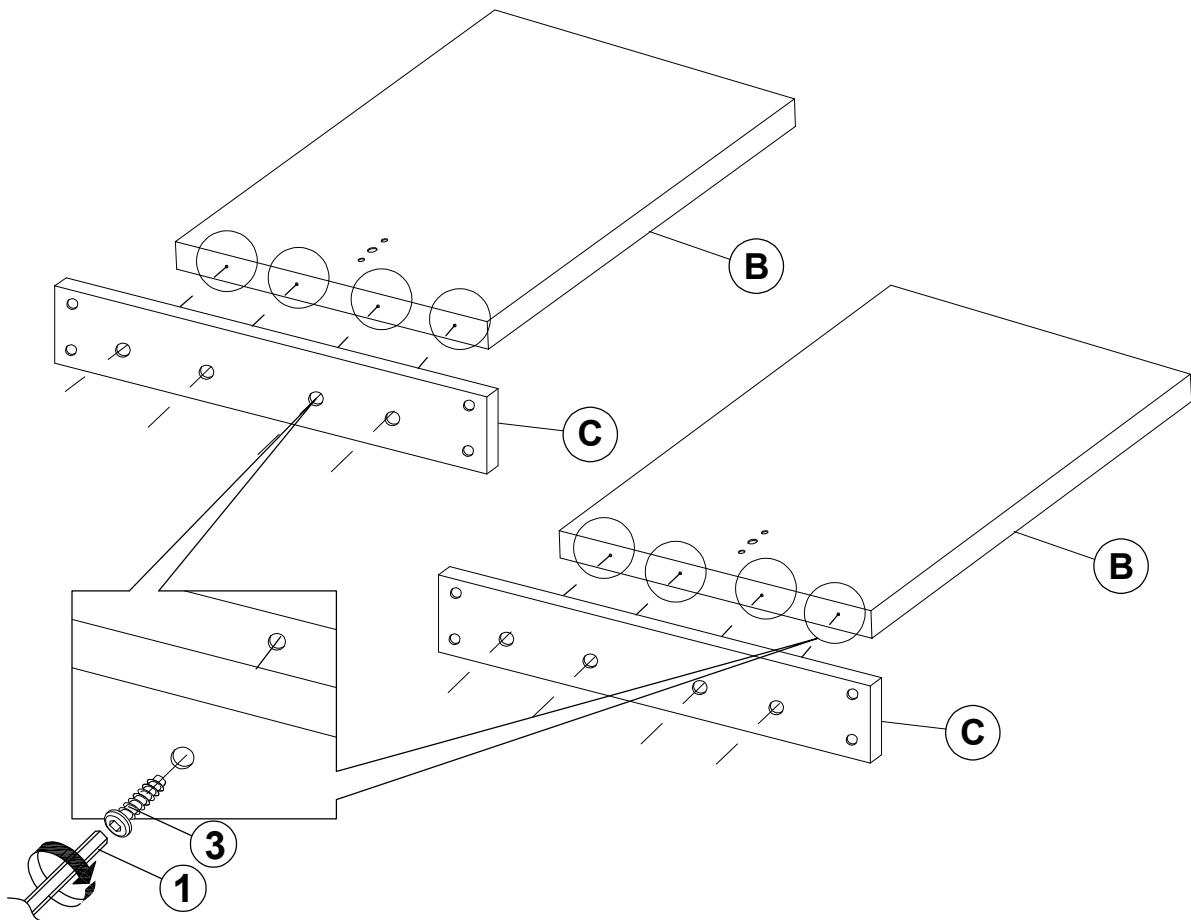

ITEM: **706477**
ASSEMBLY INSTRUCTIONS

STEP 3

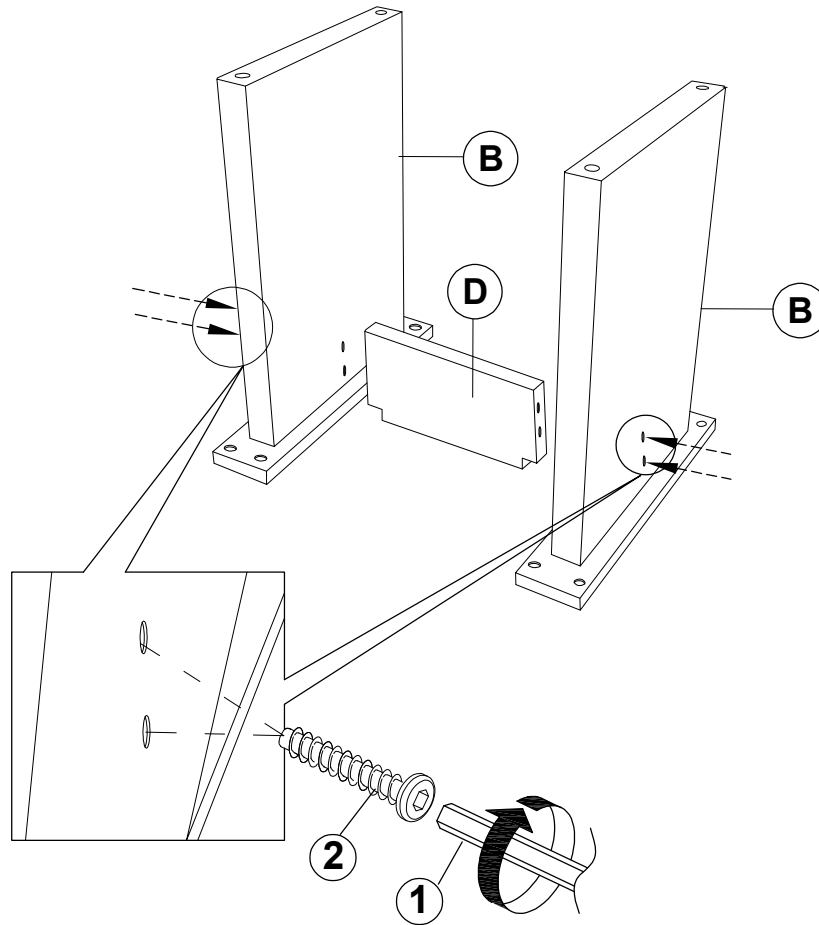

STEP 4

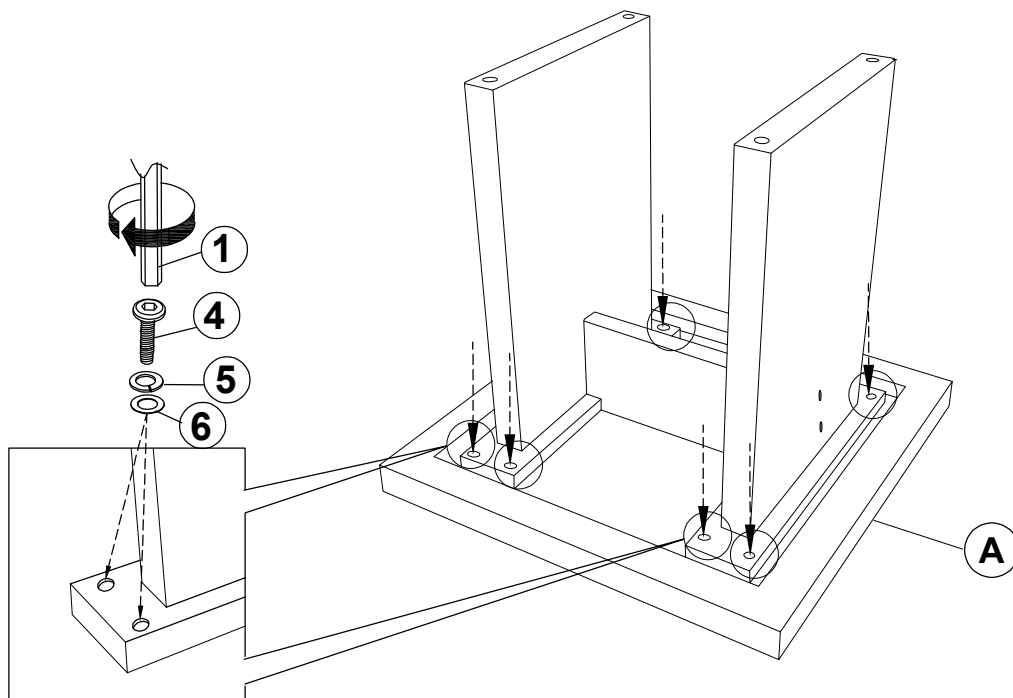

ITEM: **706477**

ASSEMBLY INSTRUCTIONS



STEP 5

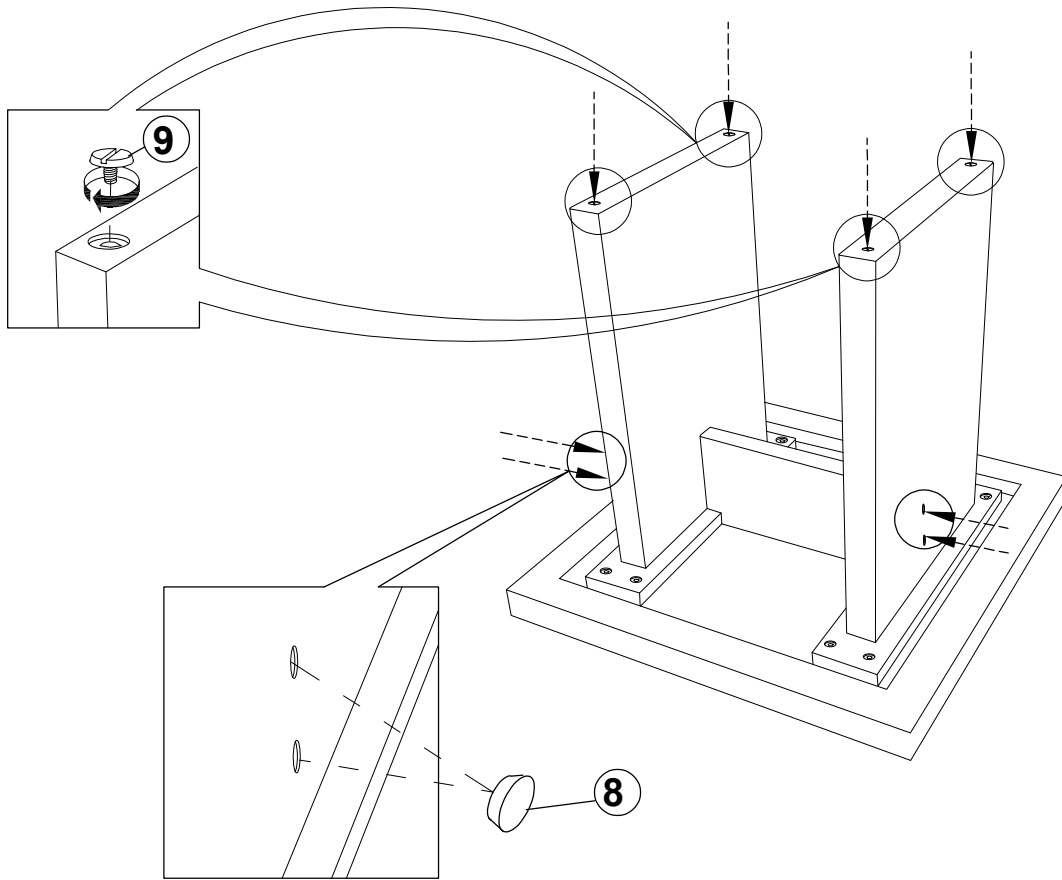

STEP 6
COMPLETE

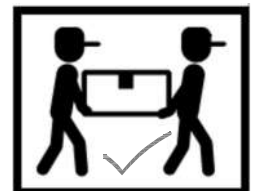
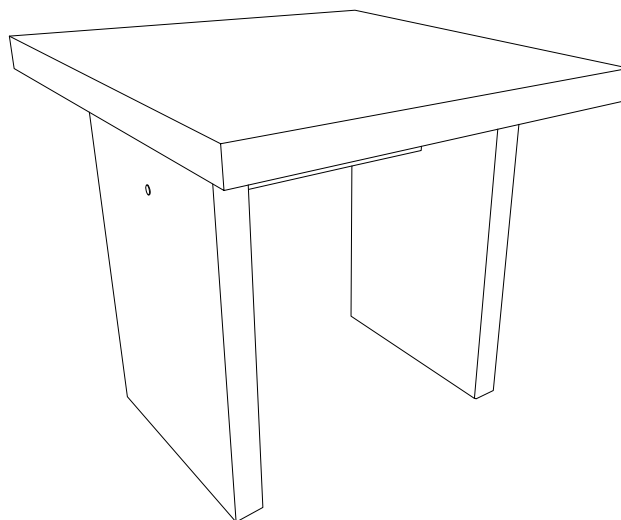

ITEM: 706477

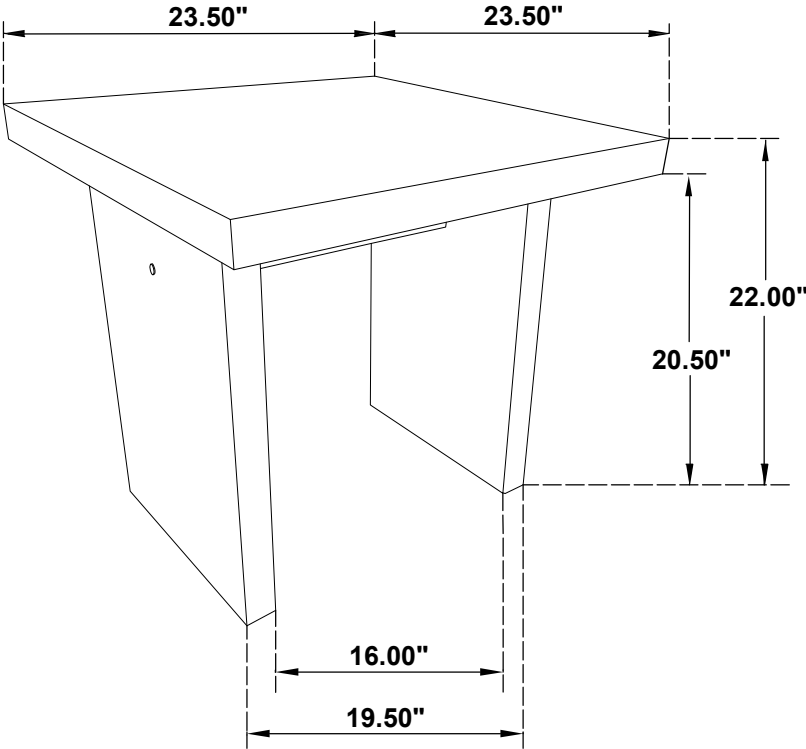

Note: Dimension tolerance $\pm 5\%$

ASSEMBLY INSTRUCTIONS
COASTER FINE FURNITURE



Fine Furniture for every stage of life

706478
Coffee Table

ITEM: 706478



ASSEMBLY INSTRUCTIONS

ASSEMBLY TIPS:

1. Remove hardware from box and sort by size.
2. Please check to see that all hardware and parts are present prior to start of assembly.
3. Please follow attached instructions in the same sequence as numbered to assure fast & easy assembly.



WARNING!

1. Don't attempt to repair or modify parts that are broken or defective. Please contact the store immediately.
2. This product is for home use only and not intended for commercial establishments.



ASSEMBLY TIME

15 MINUTES

PARTS IDENTIFICATION

A	TOP		1PC
B	LEG		2PCS
C	MOUNTING BOARD		2PCS
D	CENTER SUPPORT		1PC

HARDWARE IDENTIFICATION

1	ALLEN WRENCH (M4 x 63MM - BLK)		1PC
2	LONG HEX HEAD SCREW (M7 x 50MM - RBW)		4PCS
3	SHORT HEX HEAD SCREW (M7 x 35MM - RBW)		8PCS
4	BOLT (M6 x 30MM - RBW)		8PCS
5	LOCK WASHER (1/4" - BLK)		8PCS
6	FLAT WASHER (M6 x 13MM - RBW)		8PCS
7	WOOD DOWEL (M10 x 30MM)		2PCS
8	WOOD PLUG (Ø14.5 x 9MM)		4PCS
9	LEVELER (M6 x 14.8MM)		4PCS

ITEM: **706478**

ASSEMBLY INSTRUCTIONS



STEP 1

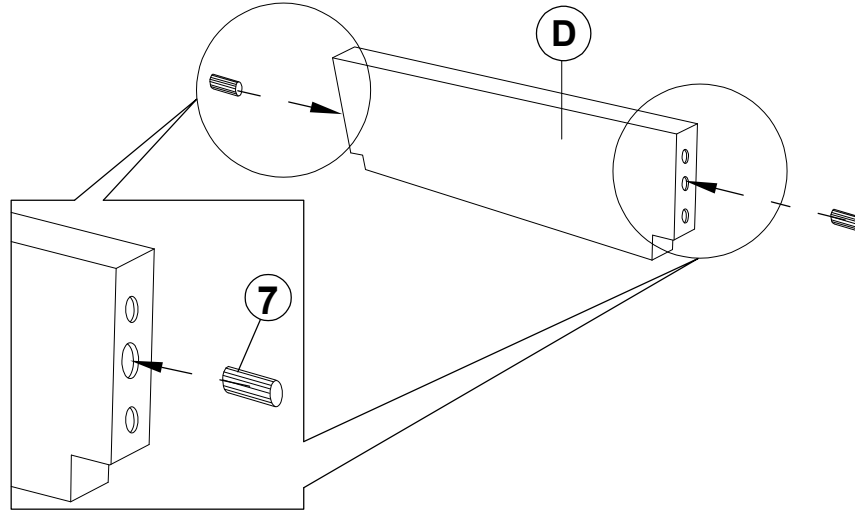

STEP 2

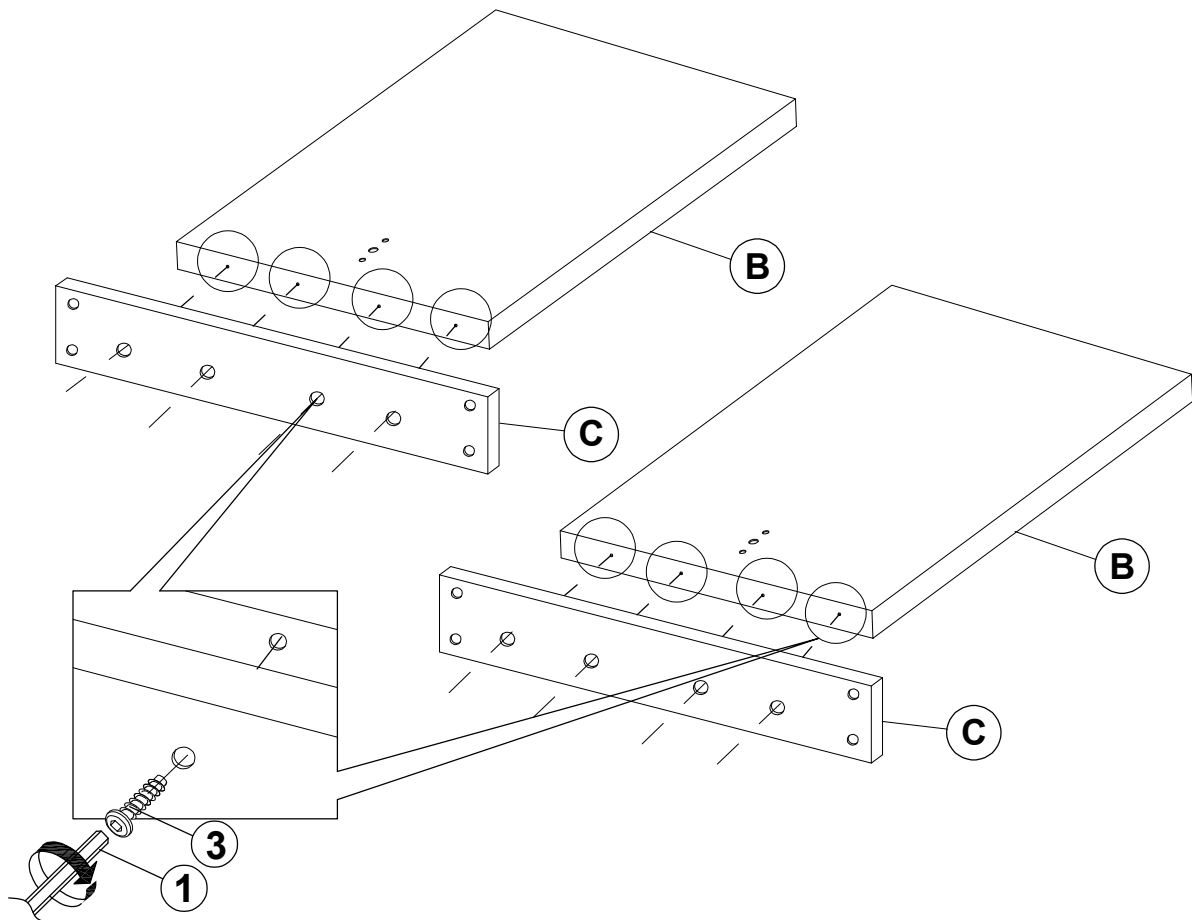

ITEM: **706478**

ASSEMBLY INSTRUCTIONS



STEP 3

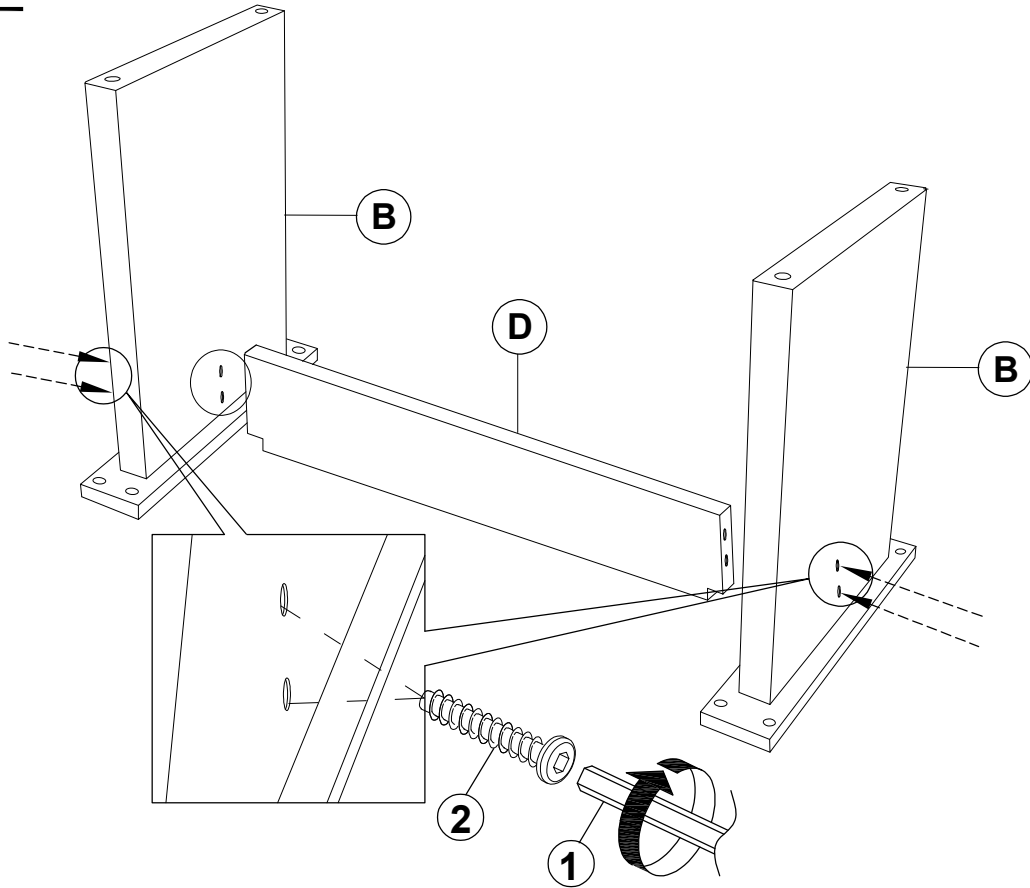

STEP 4

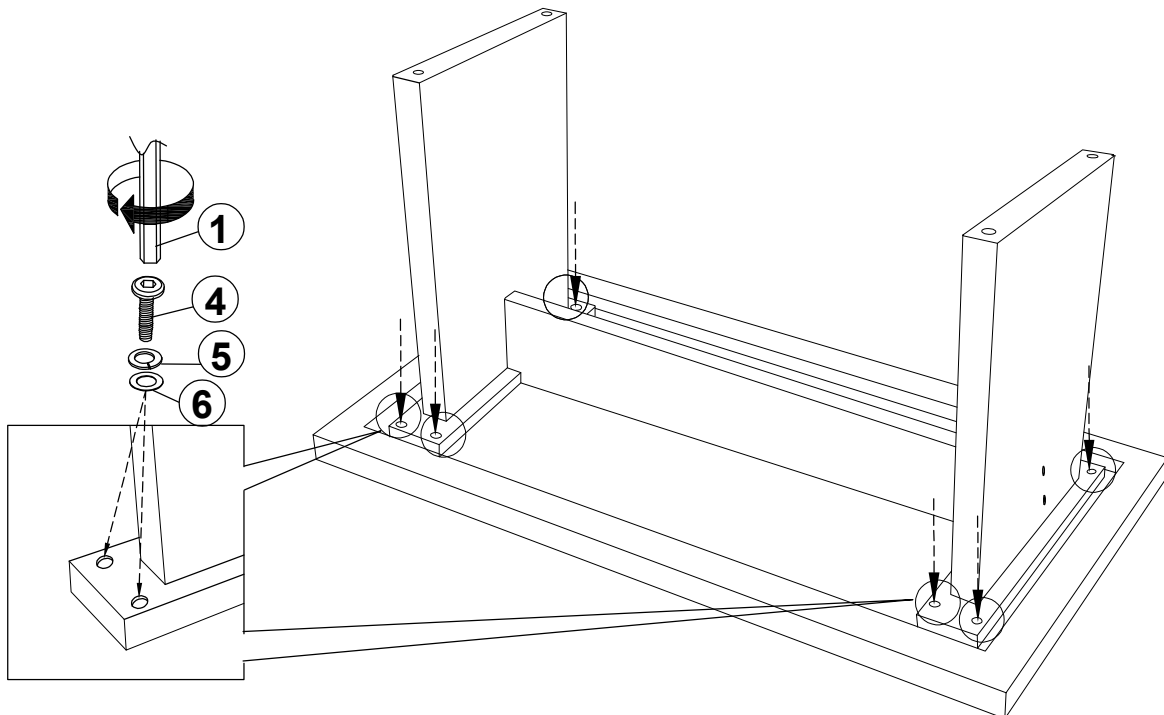

ITEM: **706478**

ASSEMBLY INSTRUCTIONS



STEP 5

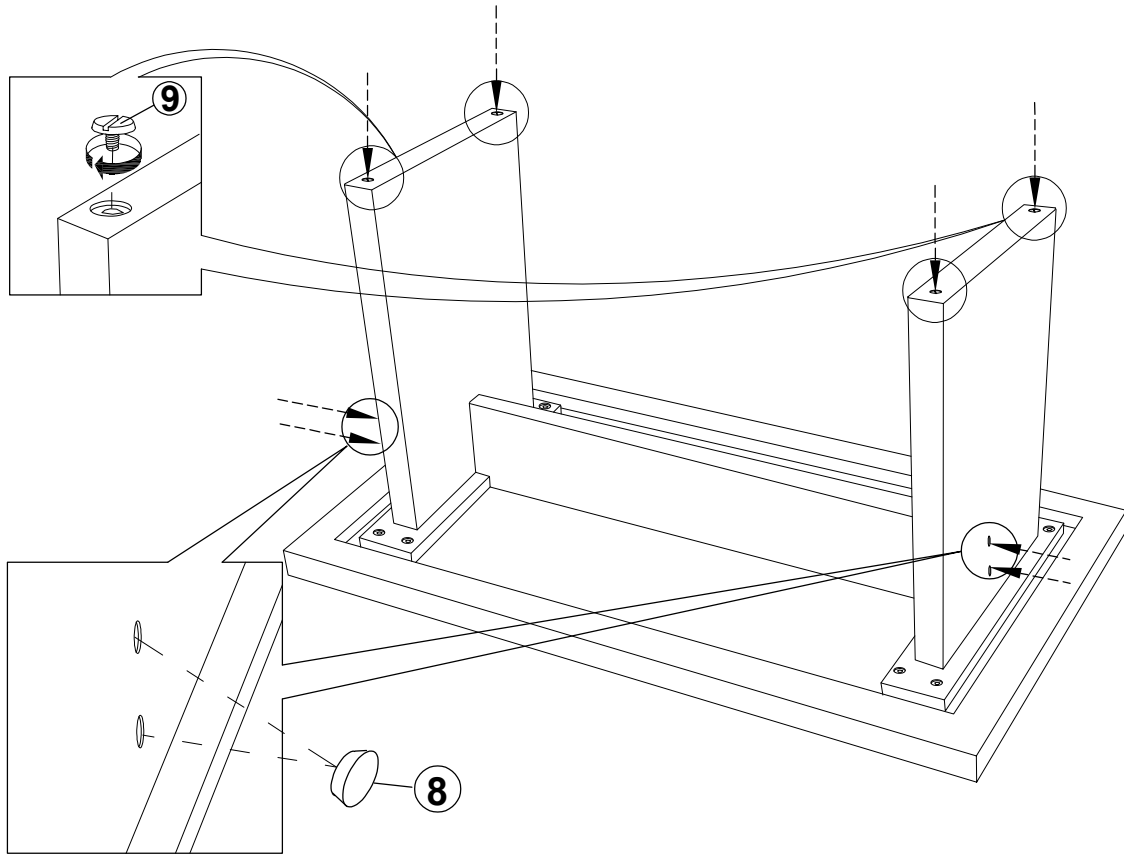

STEP 6
COMPLETE

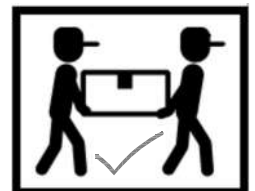
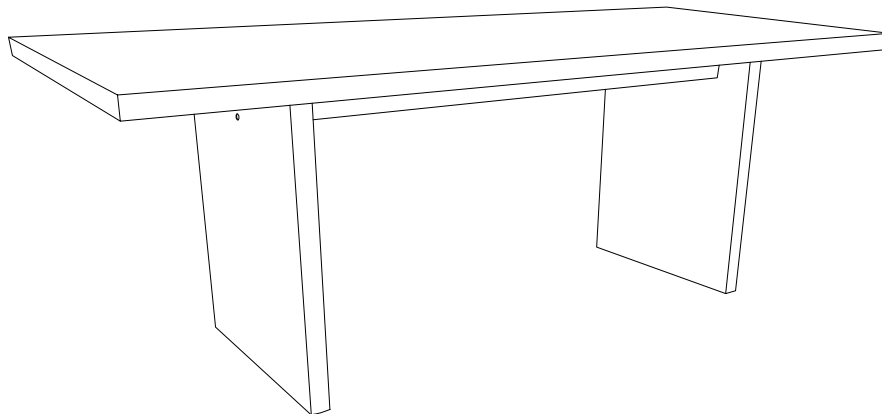

ITEM: **706478**

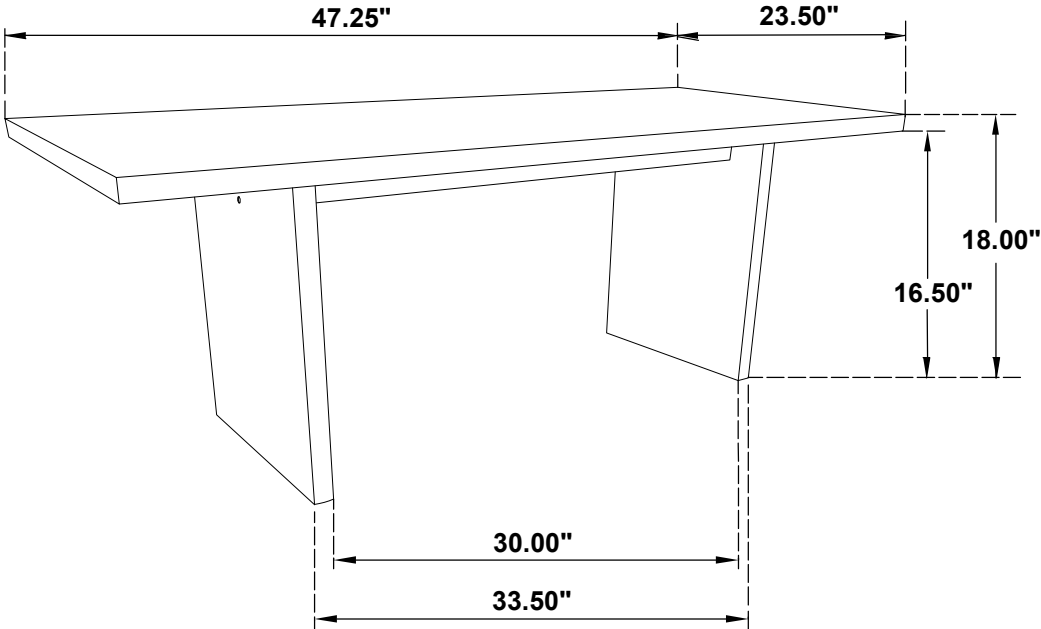

Note: Dimension tolerance $\pm 5\%$