

ASSEMBLY INSTRUCTIONS
COASTER FINE FURNITURE



Fine Furniture for every stage of life

706517
End Table

ITEM: 706517

ASSEMBLY INSTRUCTIONS



ASSEMBLY TIPS:

1. Remove hardware from box and sort by size.
2. Please check to see that all hardware and parts are present prior to start of assembly.
3. Please follow attached instructions in the same sequence as numbered to assure fast & easy assembly.



WARNING!

1. Don't attempt to repair or modify parts that are broken or defective. Please contact the store immediately.
2. This product is for home use only and not intended for commercial establishments.



ASSEMBLY TIME

15 MINUTES

PARTS IDENTIFICATION

A	TOP		1PC
B	MOUNTING PLATE (PRE-ATTACHED TO TOP)		1PC
C	LEG		3PCS

HARDWARE IDENTIFICATION

1	ALLEN WRENCH (M4 x 63MM - BLK)		1PC
2	LONG BOLT (M7 x 50MM - RBW)		6PCS
3	SHORT BOLT (M7 x 35MM - RBW)		8PCS
4	LOCK WASHER (1/4" - BLK)		14PCS
5	SMALL FLAT WASHER (M6 x 13MM - RBW)		6PCS
6	BIG FLAT WASHER (M6 x 13MM - RBW)		8PCS
7	LEVELER (M6 x 24MM)		6PCS

ITEM: **706517**



ASSEMBLY INSTRUCTIONS

STEP 1

Unscrew all hardware Short Bolt, Lock Washer & Big Flat Washer.
Keep the hardware to be use in **STEP 5**.

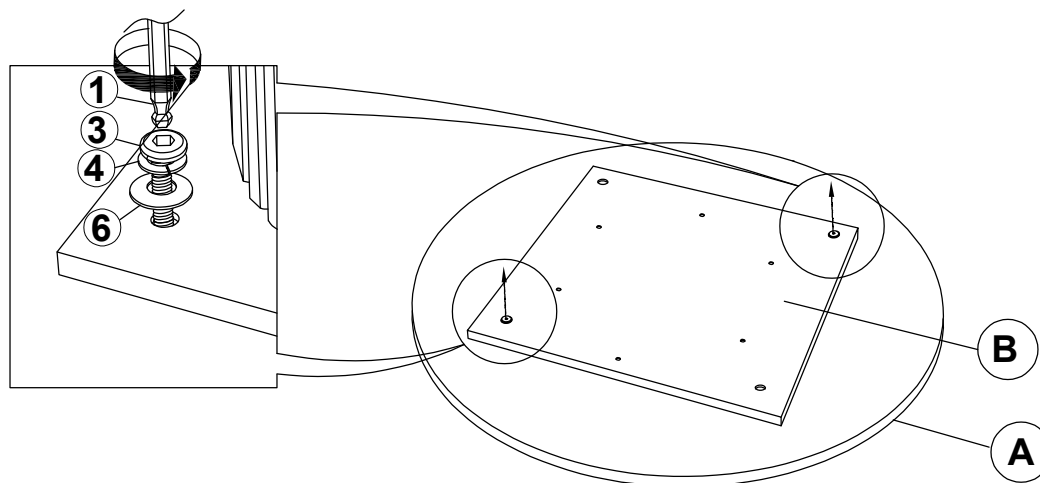

STEP 2

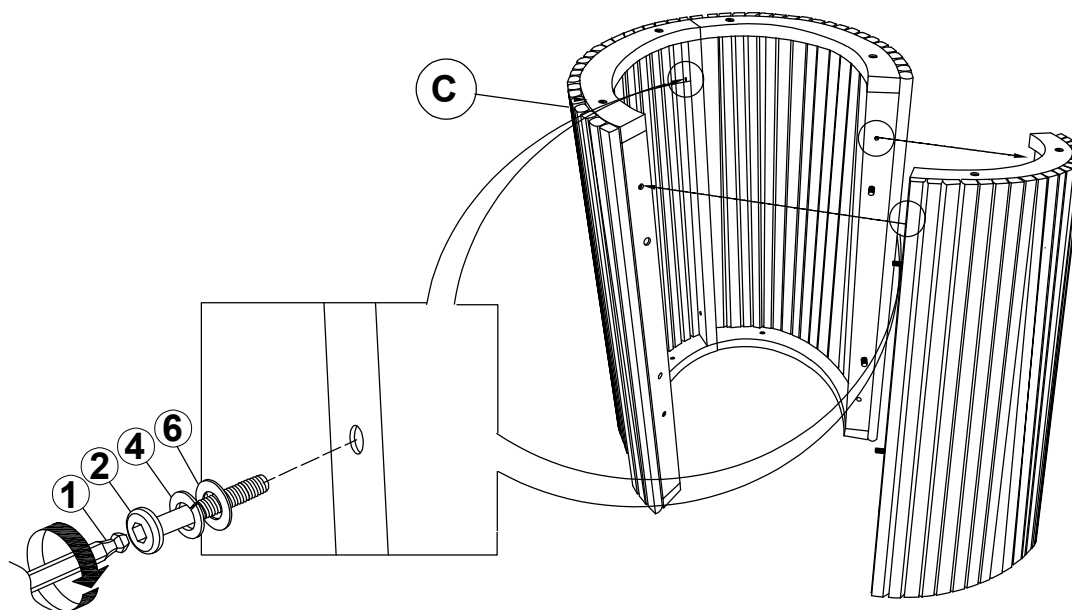

ITEM: 706517

ASSEMBLY INSTRUCTIONS



STEP 3

Attention! Carefully turn the table base assembly to the other side before proceeding with the next step.

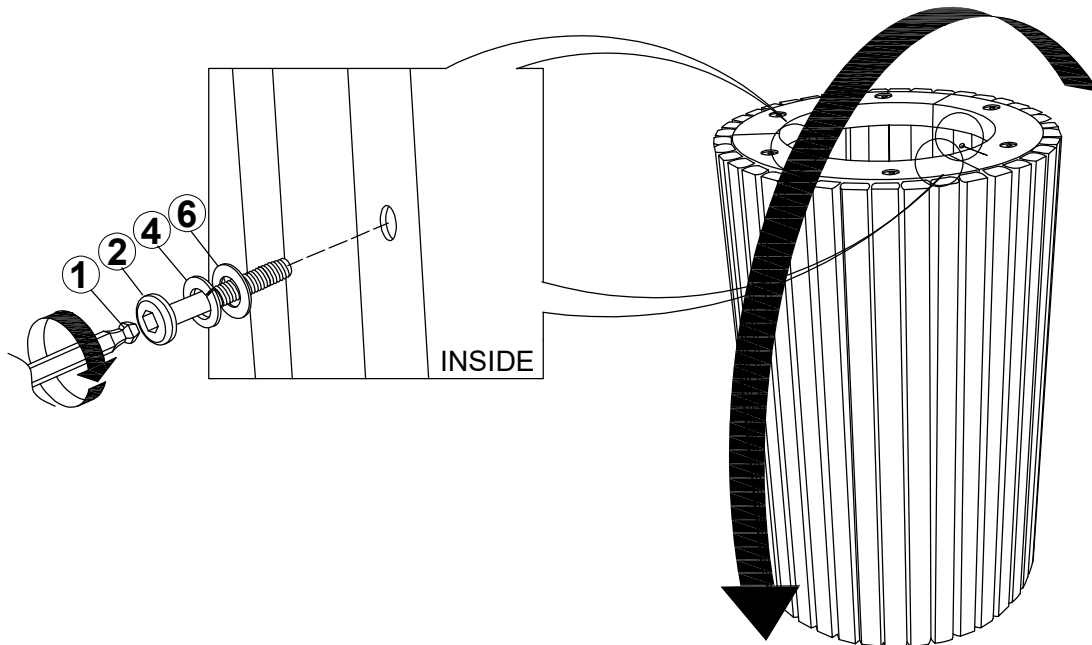

STEP 4

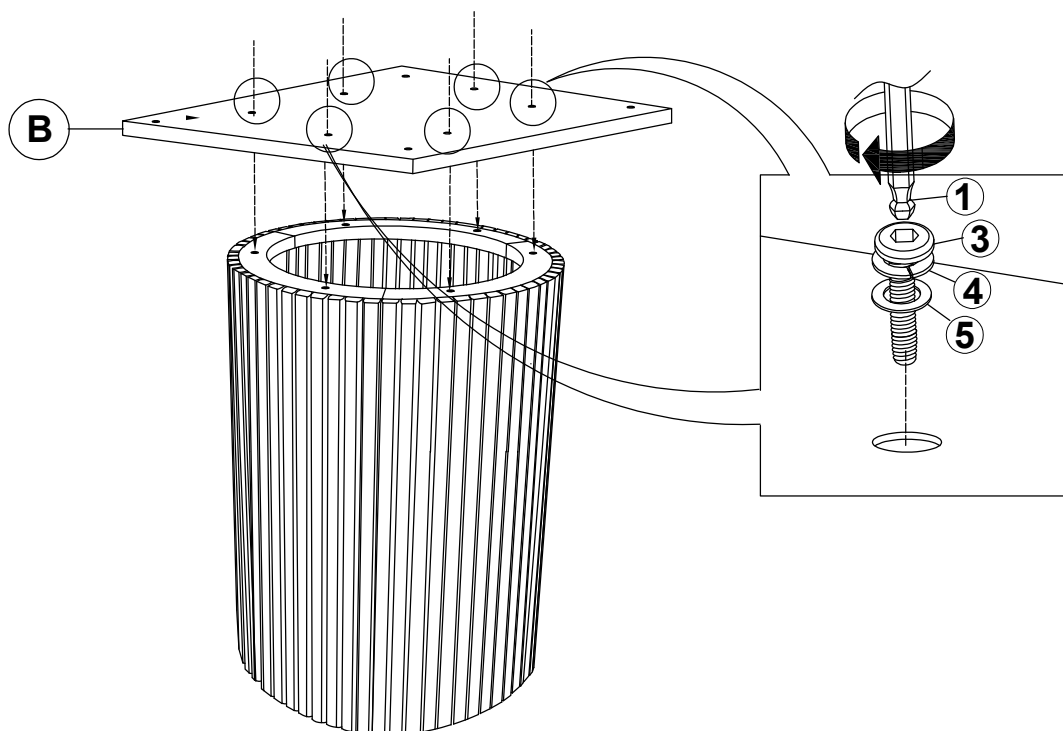

ITEM: **706517**
ASSEMBLY INSTRUCTIONS



STEP 5

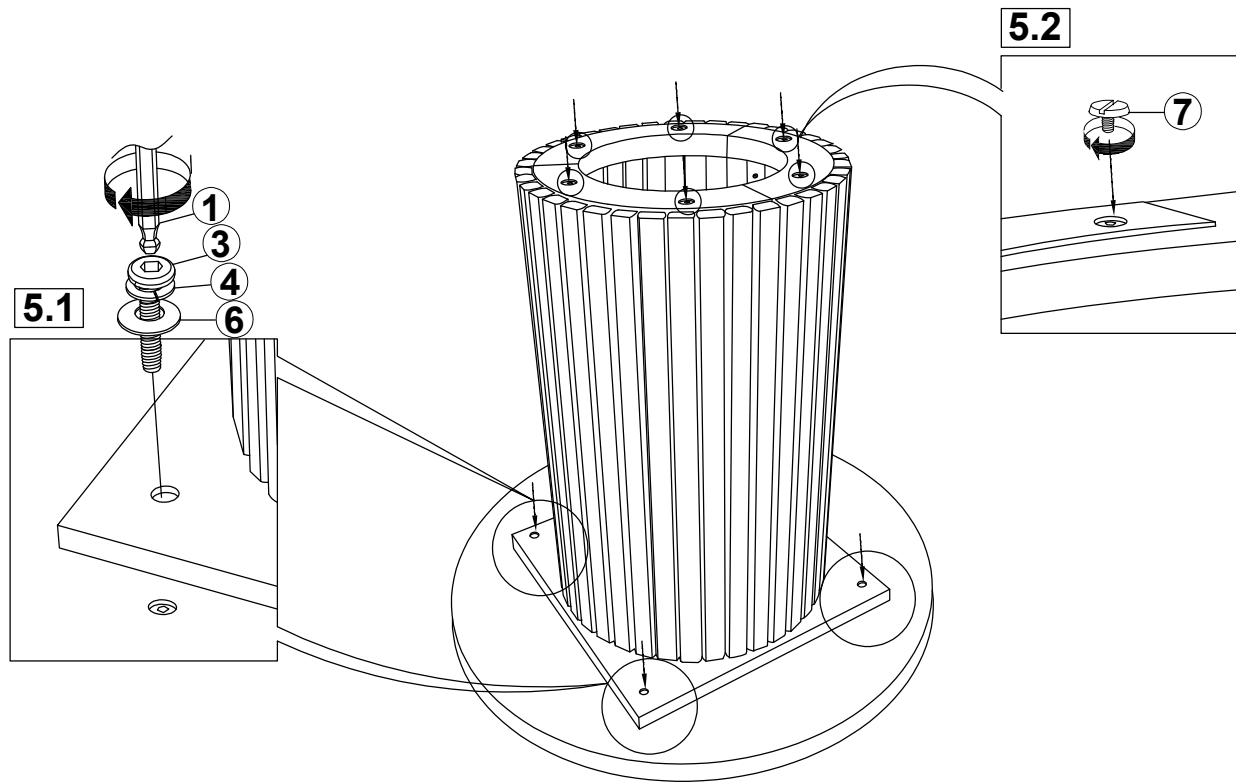

STEP 6
COMPLETE

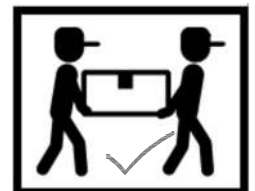
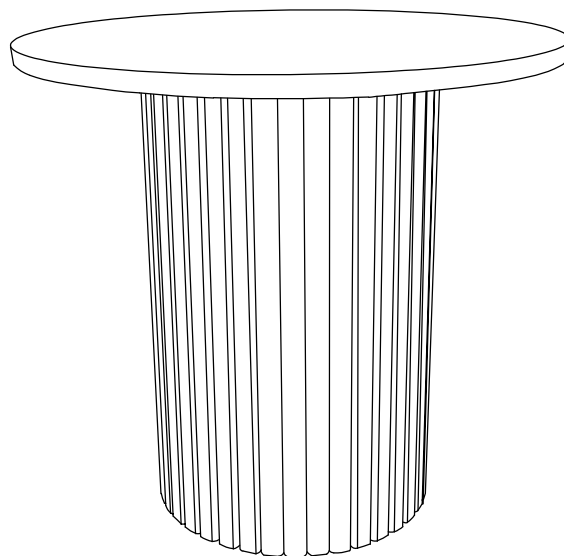

ITEM: **706517**

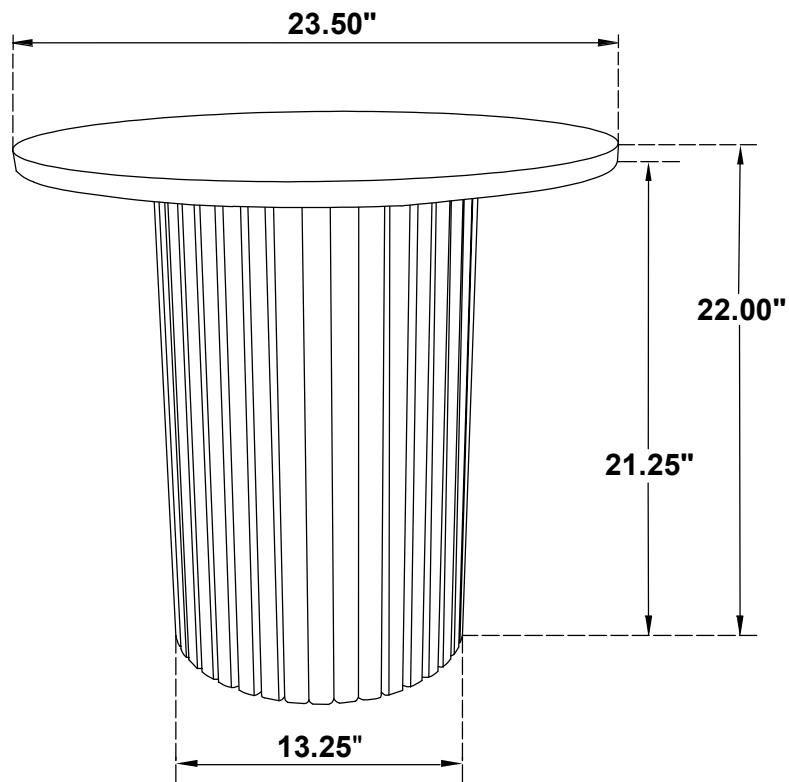

Note: Dimension tolerance $\pm 5\%$