

ASSEMBLY INSTRUCTIONS
COASTER FINE FURNITURE



Fine Furniture for every stage of life

722828
Coffee Table

ITEM: 722828



ASSEMBLY INSTRUCTIONS

ASSEMBLY TIPS:

1. Remove hardware from box and sort by size.
2. Please check to see that all hardware and parts are present prior to start of assembly.
3. Please follow attached instructions in the same sequence as numbered to assure fast & easy assembly.



WARNING!

1. Don't attempt to repair or modify parts that are broken or defective. Please contact the store immediately.
2. This product is for home use only and not intended for commercial establishments.



ASSEMBLY TIME

15 MINUTES

PARTS IDENTIFICATION

A	TOP		1PC
B	LEG		2PCS

HARDWARE IDENTIFICATION

1	CAM BOLT (5534-885-300 - ZB)		8PCS
2	CAM NUT (5656-885-300 - ZB)		8PCS
3	LEVELER (M6 x 14.8mm)		4PCS

ITEM: **722828**

ASSEMBLY INSTRUCTIONS



STEP 1

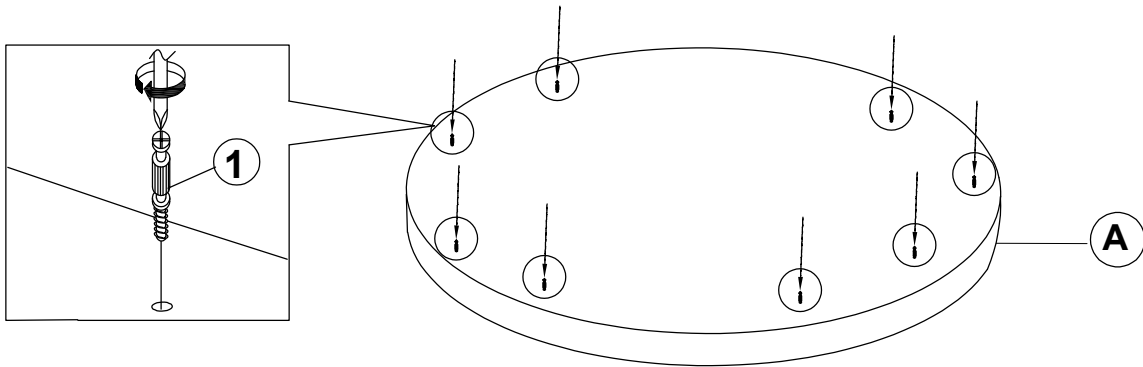
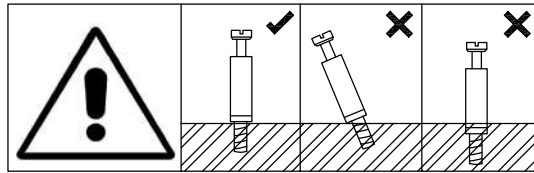

STEP 2

Make sure the arrow on each cam nut points toward the cam bolt it will secure.

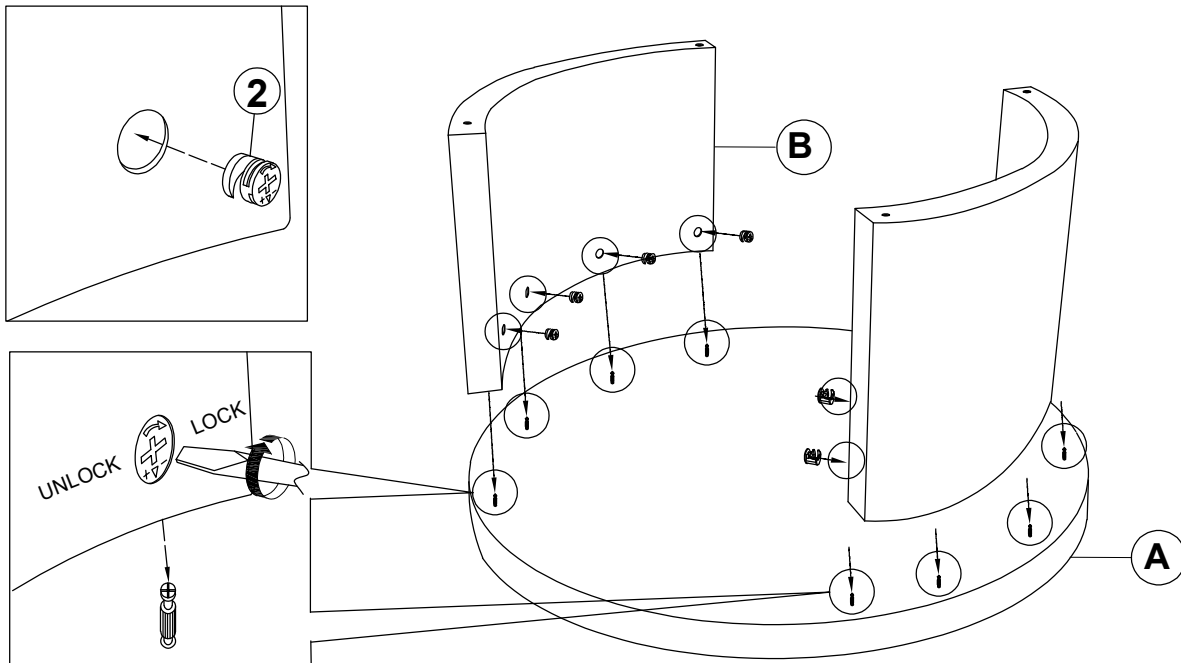

ITEM: **722828**

ASSEMBLY INSTRUCTIONS



STEP 3

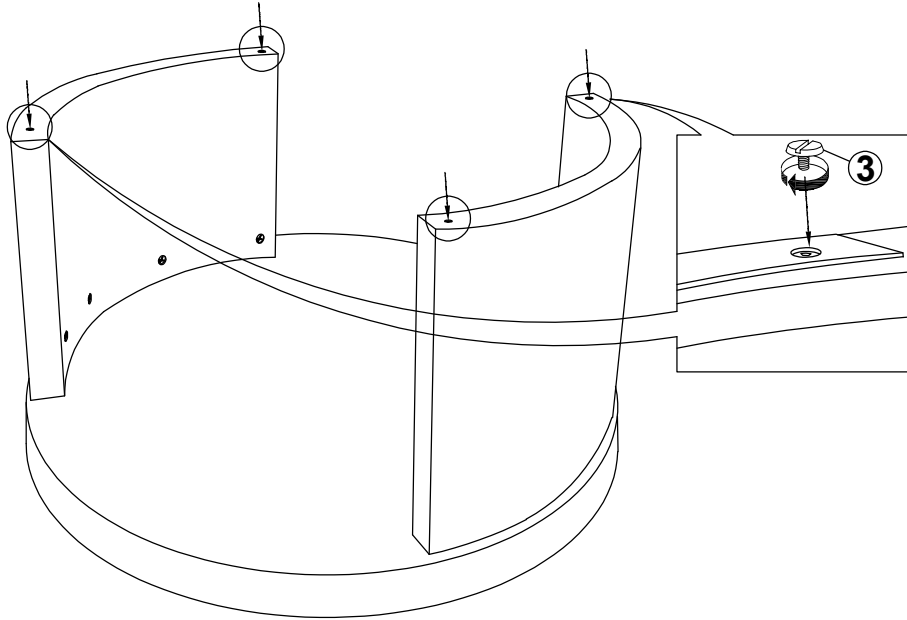

STEP 4
COMPLETE

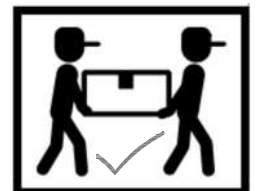
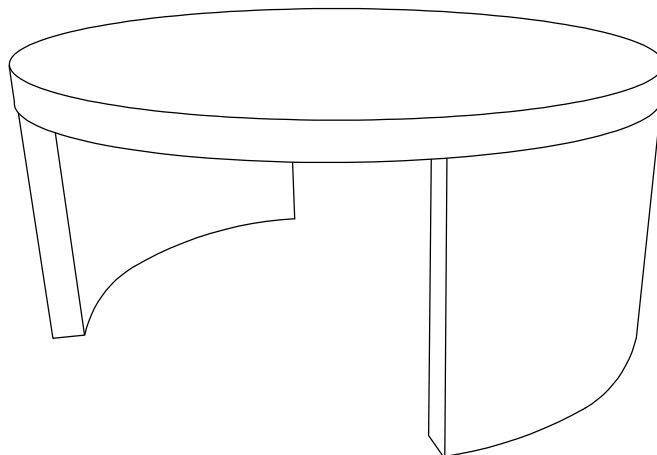

ITEM: **722828**

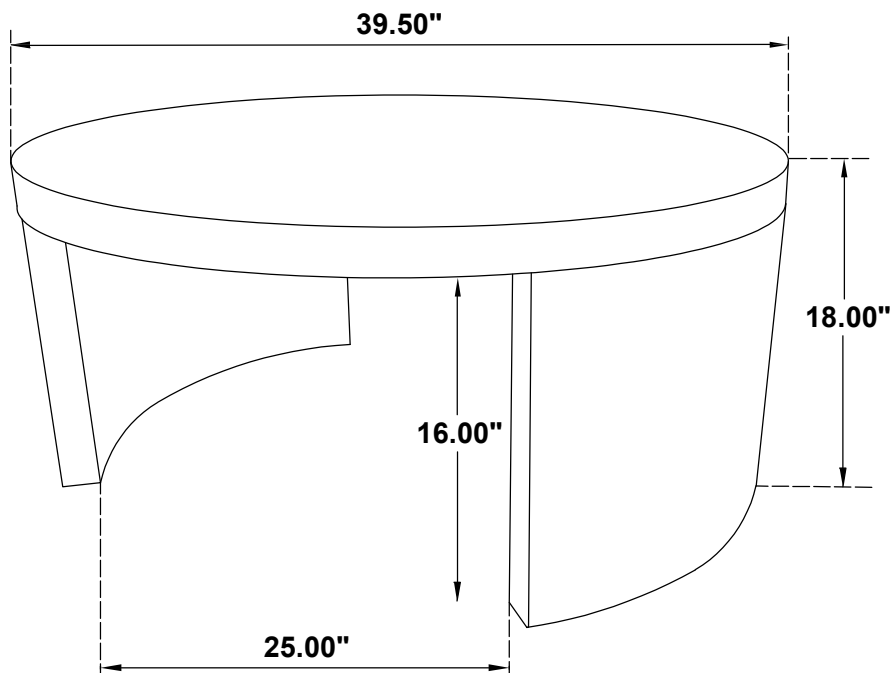

Note: Dimension tolerance $\pm 5\%$