

ASSEMBLY INSTRUCTIONS
COASTER FINE FURNITURE



Fine Furniture for every stage of life

722830
2Pc Nesting Table

ITEM: 722830



ASSEMBLY INSTRUCTIONS

ASSEMBLY TIPS:

1. Remove hardware from box and sort by size.
2. Please check to see that all hardware and parts are present prior to start of assembly.
3. Please follow attached instructions in the same sequence as numbered to assure fast & easy assembly.



WARNING!

1. Don't attempt to repair or modify parts that are broken or defective. Please contact the store immediately.
2. This product is for home use only and not intended for commercial establishments.



ASSEMBLY TIME

20 MINUTES

PARTS IDENTIFICATION

A COFFEE TABLE TOP

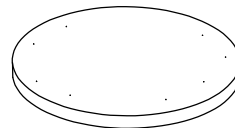

1PC

B COFFEE TABLE LEG

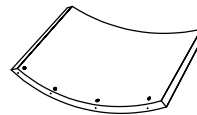

2PCS

C END TABLE TOP

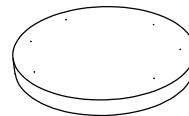

1PC

D END TABLE LEG

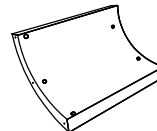

2PCS

E END TABLE BASE



1PC

ITEM: 722830



ASSEMBLY INSTRUCTIONS

ASSEMBLY TIPS:







1. Remove hardware from box and sort by size.
2. Please check to see that all hardware and parts are present prior to start of assembly.
3. Please follow attached instructions in the same sequence as numbered to assure fast & easy assembly.



WARNING!

1. Don't attempt to repair or modify parts that are broken or defective. Please contact the store immediately.
2. This product is for home use only and not intended for commercial establishments.

HARDWARE IDENTIFICATION

1	ALLEN WRENCH (M4 x 63mm - BLK)		1PC
2	BOLT (M6 x 30mm - RBW)		4PCS
3	LOCK WASHER (1/4" - BLK)		4PCS
4	FLAT WASHER (1/4" - RBW)		4PCS
5	CAM BOLT (5534-885-300 - ZB)		14PCS
6	CAM NUT (5656-885-300 - ZB)		14PCS
7	LEVELER (M6 x 14.8mm)		8PCS

ITEM: **722830**

ASSEMBLY INSTRUCTIONS



STEP 1

COFFEE TABLE

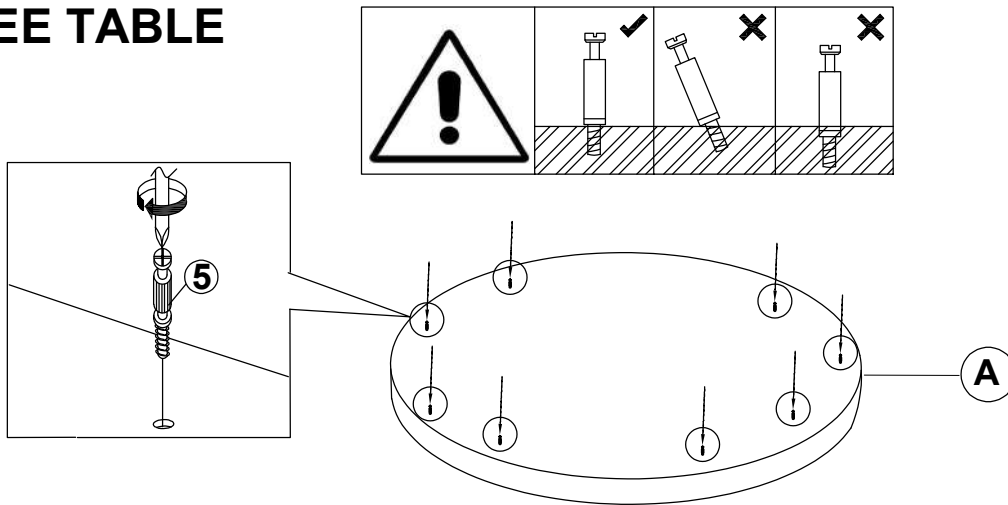

STEP 2

Make sure the arrow on each cam nut points toward the cam bolt it will secure.

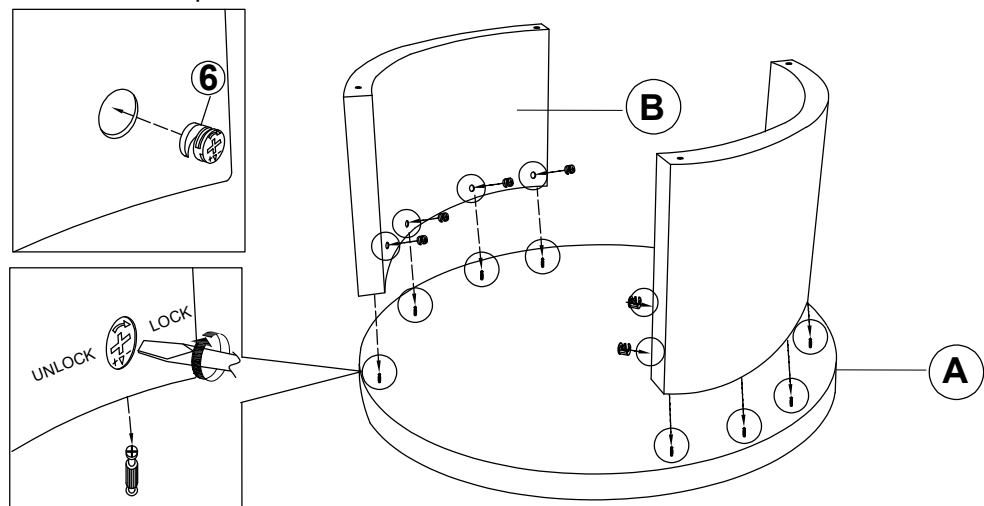

STEP 3

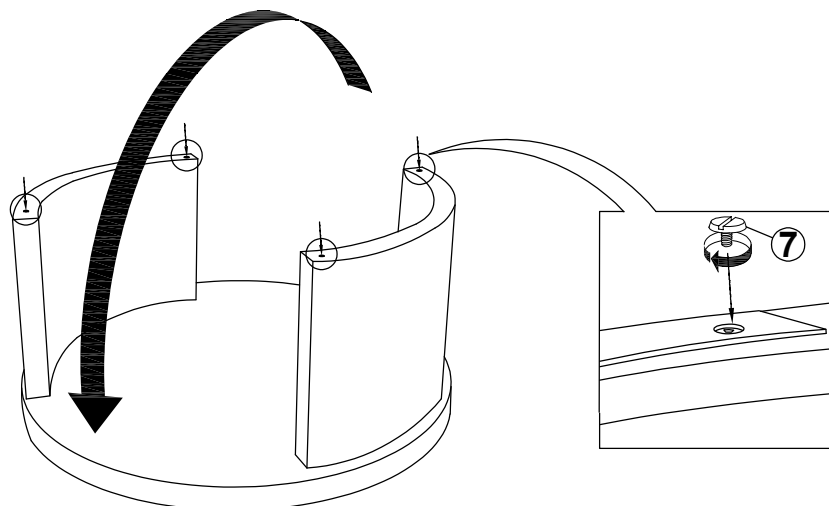

ITEM: **722830**

ASSEMBLY INSTRUCTIONS



STEP 4

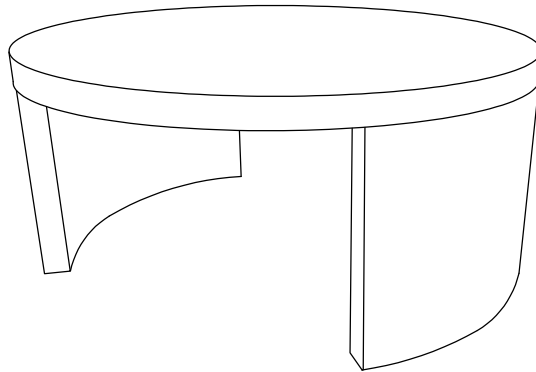

STEP 5

END TABLE

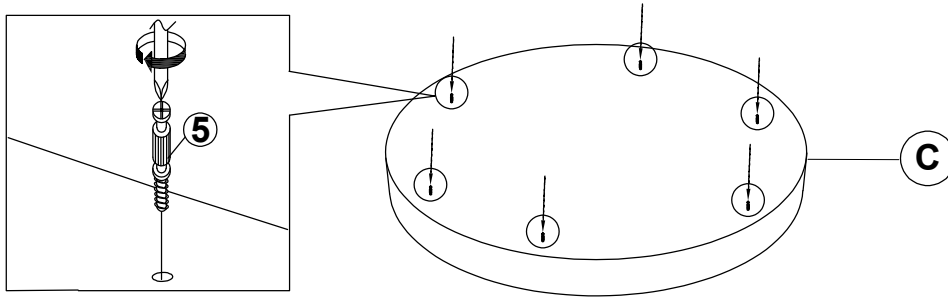

STEP 6

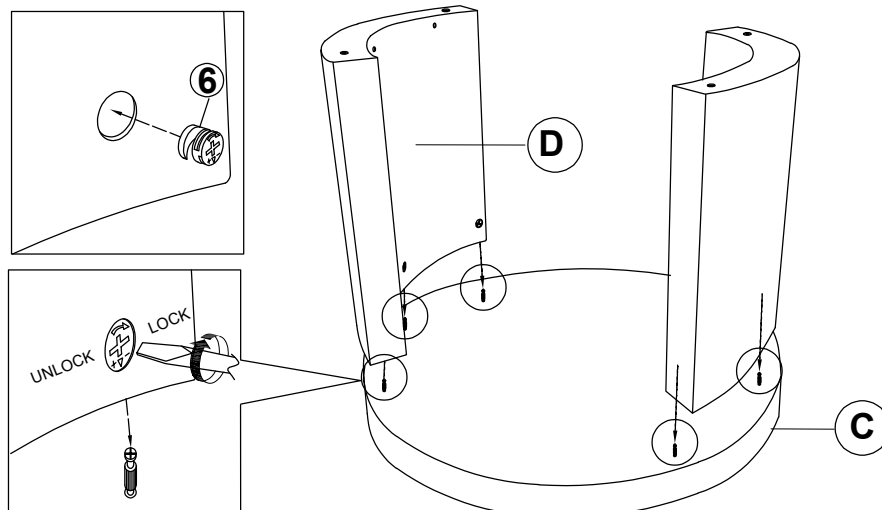

ITEM: **722830**

ASSEMBLY INSTRUCTIONS



STEP 7

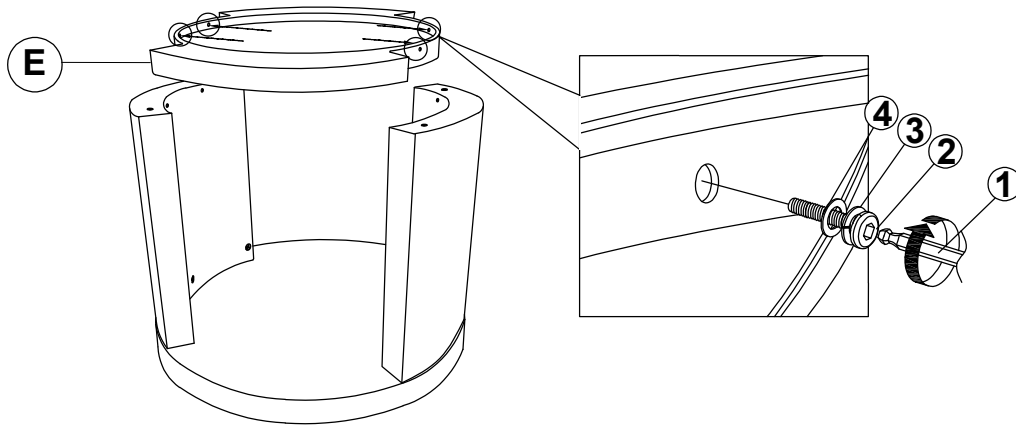

STEP 8

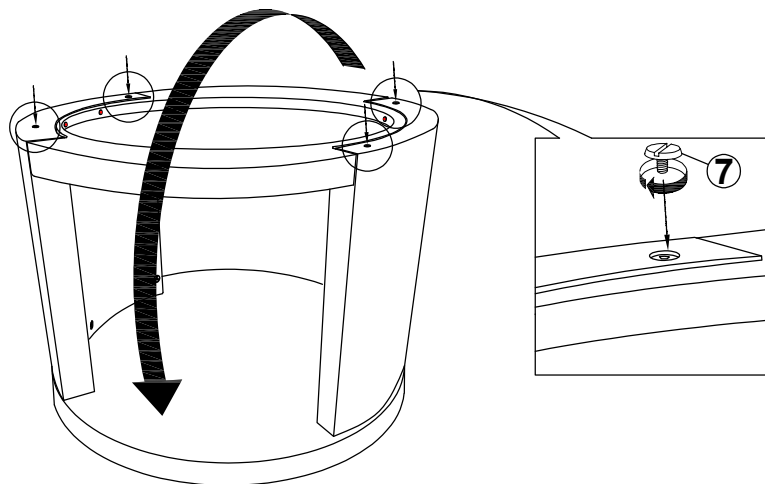

STEP 9
COMPLETE

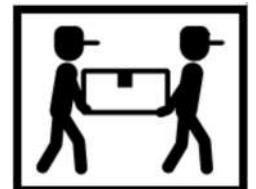
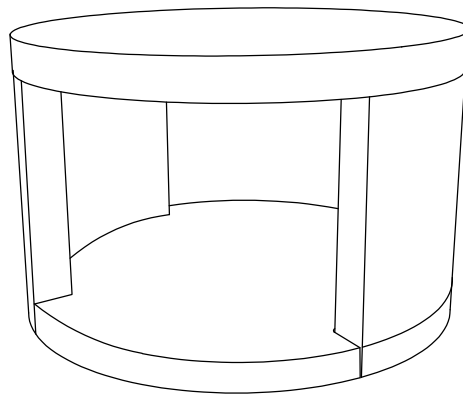

ITEM: 722830

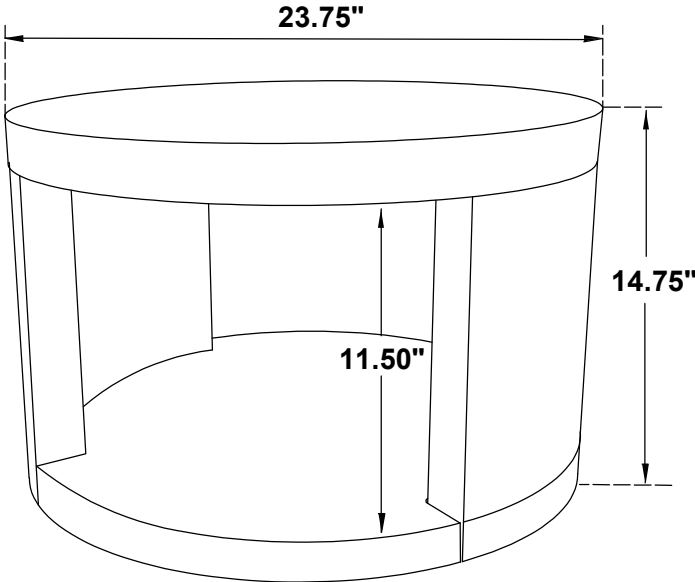
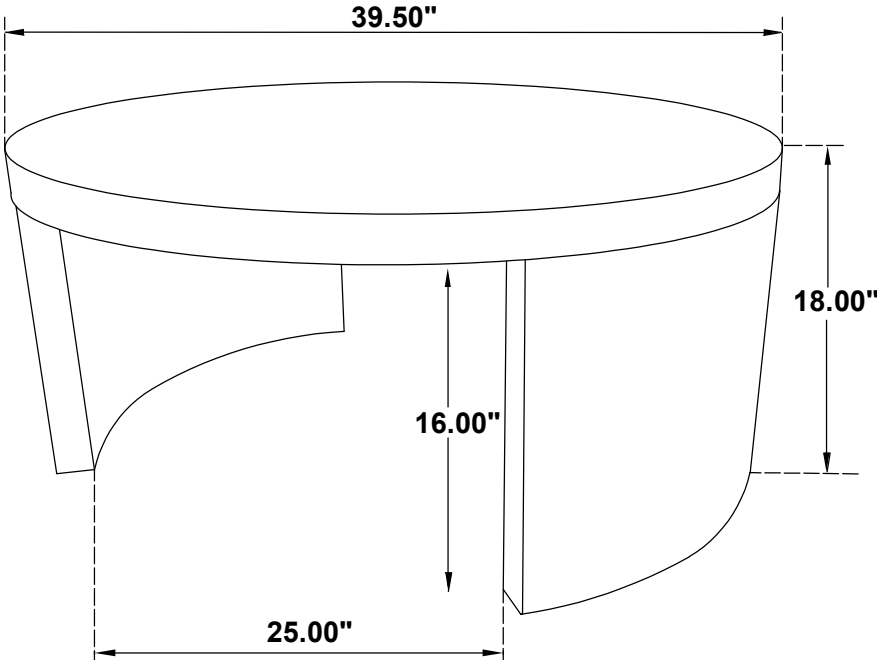

Note: Dimension tolerance $\pm 5\%$