

HEADBOARD ONLY

**ASSEMBLY INSTRUCTION
COASTER FINE FURNITURE**



www.coasterfurniture.com

ASSEMBLY TIPS:

1. Remove hardware from box and sort by size.
2. Please check to see that all hardware and parts are present prior to start of assembly.
3. Please follow attached instructions in the same sequence as numbered to assure fast & easy assembly.



Warning!

1. Don't attempt to repair or modify parts that are broken or defective. Please contact the store immediately.
2. This product is for home use only and not intended for commercial establishments.



ASSEMBLY TIME PER UNIT: 20 MINUTES

PARTS IDENTIFICATION

A

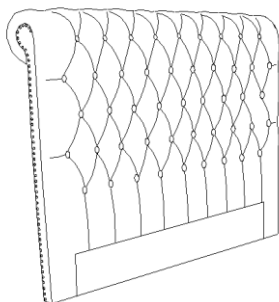





HEADBOARD 1 PC

B



LEG 2 PCS

HARDWARE PACKAGE

1	ALLEN WRENCH 5*23*73mm		1 PC
7	HEXAGON SOCKET SCREW 4cm		8 PCS
8	PLASTIC WASHER		2 PCS
9	WASHER M8		8 PCS

ALL ABOVE HARDWARE PACK IS LOCATED IN 300525KW B1

STEP 1

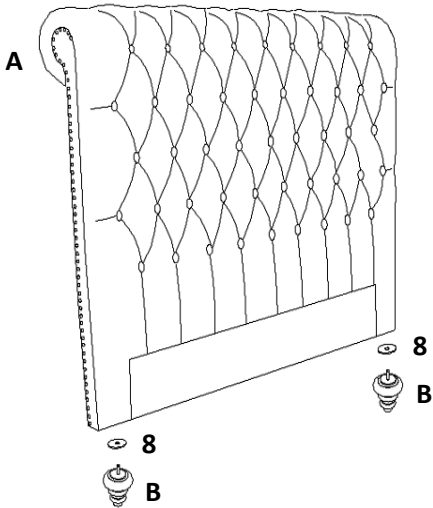

STEP 2

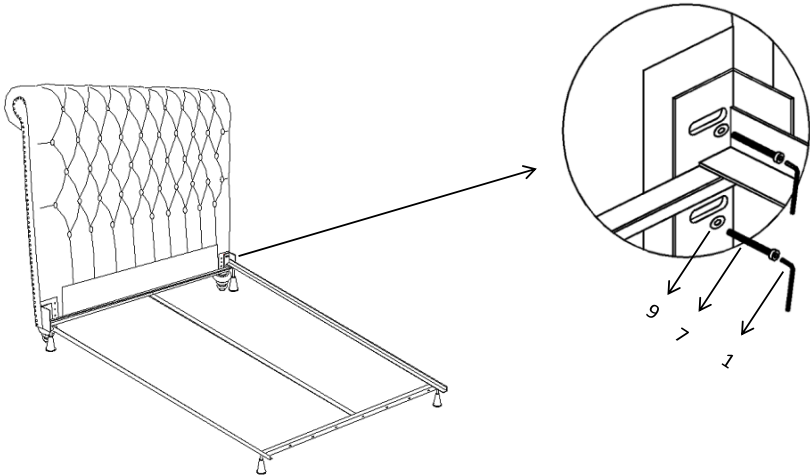

STEP 3

