

ASSEMBLY INSTRUCTIONS
COASTER FINE FURNITURE



Fine Furniture for every stage of life

900578
ACCENT TABLE

REVISION 0 : 09/25/2017
REVISION 1 : 07/29/2019

ITEM:900578



ASSEMBLY INSTRUCTIONS

ASSEMBLY TIPS:

1. Remove hardware from box and sort by size.
2. Please check to see that all hardware and parts are present prior to start of assembly.
3. Please follow attached instructions in the same sequence as numbered to assure fast & easy assembly.





WARNING!



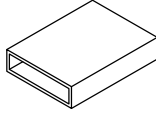
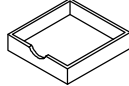

1. Don't attempt to repair or modify parts that are broken or defective. Please contact the store immediately.
2. This product is for home use only and not intended for commercial establishments.

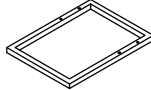
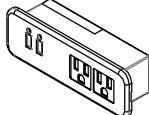
ASSEMBLY TIME 25 MINUTES

PARTS IDENTIFICATION

A	BOX		1PC
B	DRAWER		1PC
C	SIDE FRAME		2PCS
D	BOTTOM FRAME		1PC
E	POWERSOCKET		1PC

HARDWARE IDENTIFICATION

1	SHORT BOLT (1/4" x 12mm BLK)		4PCS	4	LEVELER (1/4" x 12mm BLK)		4PCS
2	LONG BOLT (1/4" x 28mm BLK)		4PCS	5	ALLEN WRENCH (4mm)		1PC
3	SCREW (8# x 3/4")		2PCS				

ITEM: 900578 ASSEMBLY INSTRUCTIONS



STEP 1 Do not tighten until each step is completed or instructed.

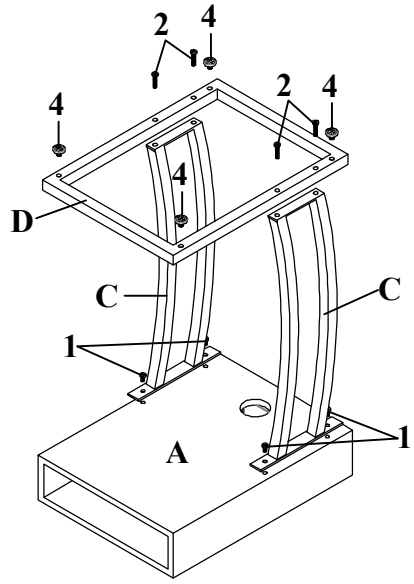

STEP 2

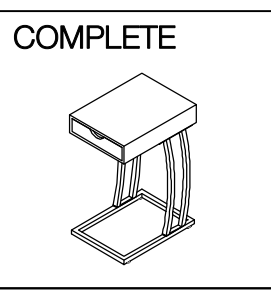
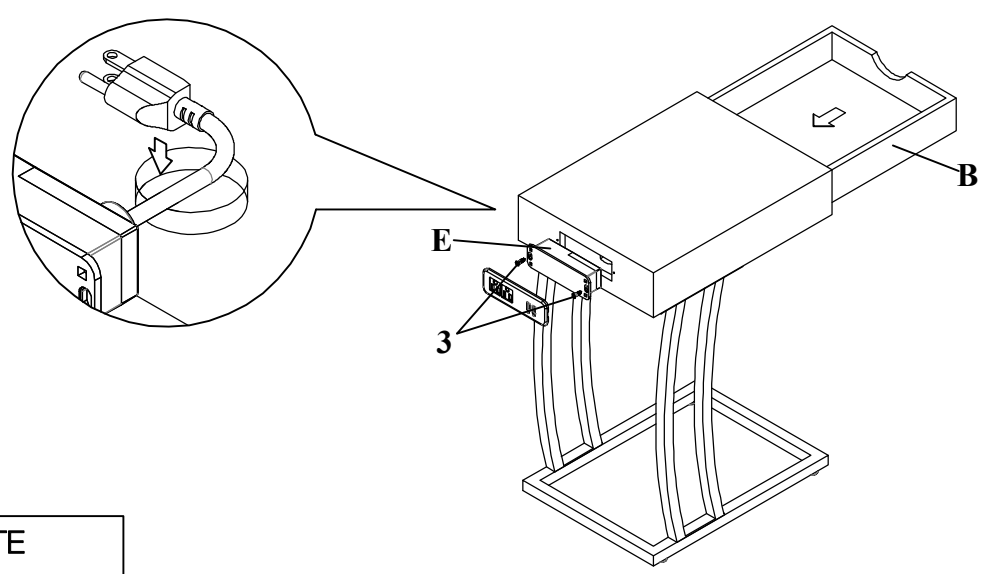

ITEM:900578 ASSEMBLY INSTRUCTIONS



Product Size : 298 X 400 X 616 H (MM)
Product Size : 11 $\frac{3}{4}$" X 15 $\frac{3}{4}$" X 24 $\frac{1}{4}$"

