

ASSEMBLY INSTRUCTIONS
COASTER FINE FURNITURE

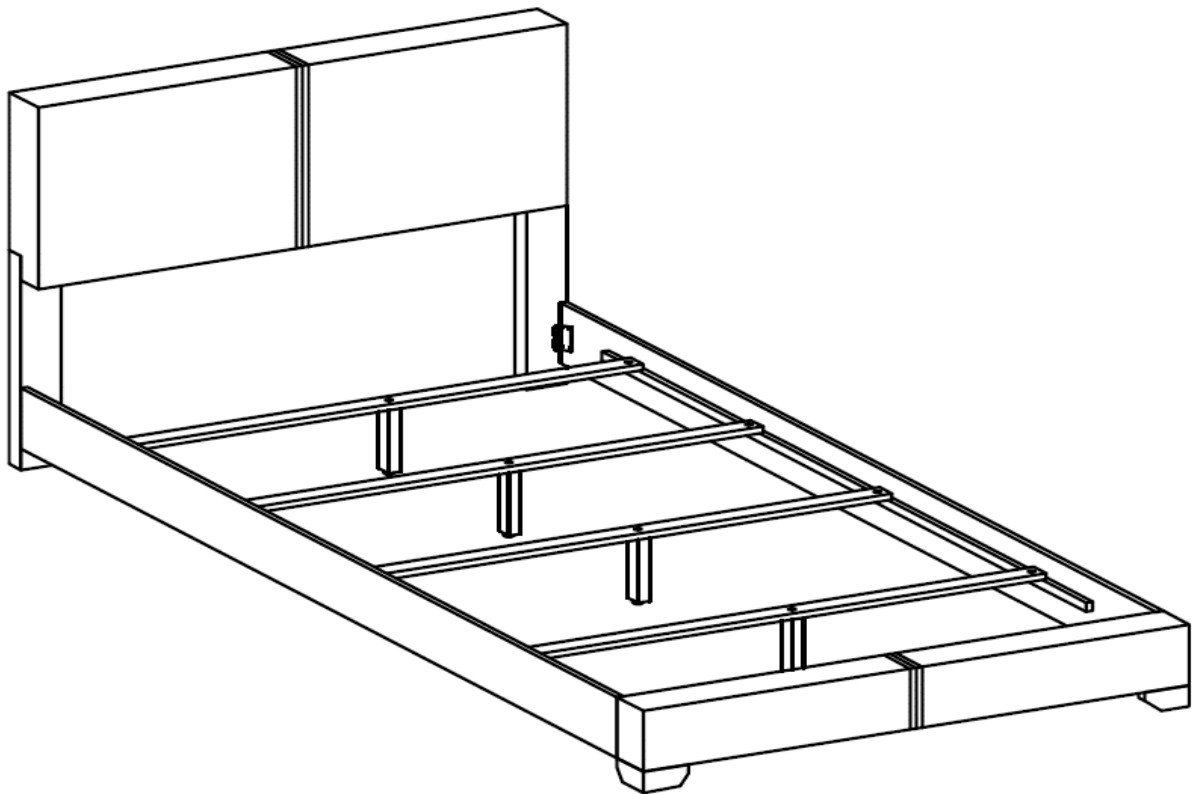

Fine Furniture for every stage of life

300261Q (B1&B2)
Queen Bed

REVISION 0 : 06/12/2011
REVISION 1 : 09/19/2011
REVISION 2 : 02/02/2012
REVISION 3 : 07/30/2014
REVISION 4 : 08/09/2019

ITEM: 300261Q (B1&B2)



ASSEMBLY INSTRUCTIONS

ASSEMBLY TIPS:

1. Remove hardware from box and sort by size.
2. Please check to see that all hardware and parts are present prior to start of assembly.
3. Please follow attached instructions in the same sequence as numbered to assure fast & easy assembly.

WARNING!



1. Don't attempt to repair or modify parts that are broken or defective. Please contact the store immediately.
2. This product is for home use only and not intended for commercial establishments.



ASSEMBLY TIME

20 MINUTES

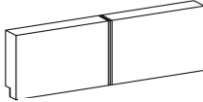
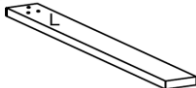

PARTS IDENTIFICATION

B1 (BOX 1)

- | | | | |
|---|--------------------|---|-----|
| A | HEADBOARD PANEL |  | 1PC |
| B | LEFT HEADBOARD LEG |  | 1PC |

- | | | | |
|---|---------------------|---|-----|
| C | RIGHT HEADBOARD LEG |  | 1PC |
|---|---------------------|---|-----|

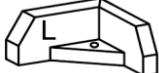

B2 (BOX 2)

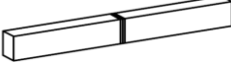
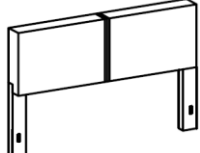
- | | | | |
|---|-------------------------------|---|------|
| D | BED SLAT |  | 4PCS |
| E | BED SLAT SUPPORT WITH LEVELER |  | 4PCS |
| F | BED RAIL |  | 2PCS |
| G | LEFT FOOTBOARD LEG |  | 1PC |

- | | | | |
|----|--|---|-----|
| H | RIGHT FOOTBOARD LEG |  | 1PC |
| I | FOOTBOARD PANEL |  | 1PC |
| HB | 300261Q (B1) FROM BOX 1 HEADBOARD COMPLETE |  | 1PC |

HARDWARE IDENTIFICATION

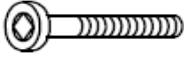
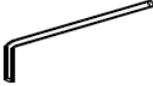
Z-B1 (BOX 1) - HARDWARE PACK IS LOCATED IN 300261Q (B1)

- | | | | | | | | |
|---|--------------------------------|---|------|---|-----------------------------------|---|-----|
| 1 | BOLT
(JCBC M6 x 50mm - RBW) |  | 6PCS | 3 | ALLEN WRENCH
(M4 x 60mm - BLK) |  | 1PC |
| 2 | LOCK WASHER
(20mm - RBW) |  | 6PCS | | | | |

Z-B2 (BOX 2) - HARDWARE PACK IS LOCATED IN 300261Q (B2)

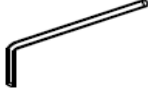
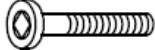
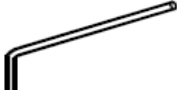
- | | | | | | | | |
|---|--|---|------|---|--|---|-----|
| 4 | FLAT HEAD SCREW
(CSK M4 x 32mm - RBW) |  | 8PCS | 6 | SMALL ALLEN WRENCH
(M4 x 100mm - BLK) |  | 1PC |
| 5 | BOLT
(JCBC M6 x 40mm - RBW) |  | 6PCS | 7 | BIG ALLEN WRENCH
(M5 x 70mm - BLK) |  | 1PC |

NOTE:

Phillips head screw driver is required in the assembly process; however, manufacturer does not provide this item.

ITEM: 300261Q (B1&B2)

ASSEMBLY INSTRUCTIONS

STEP 1

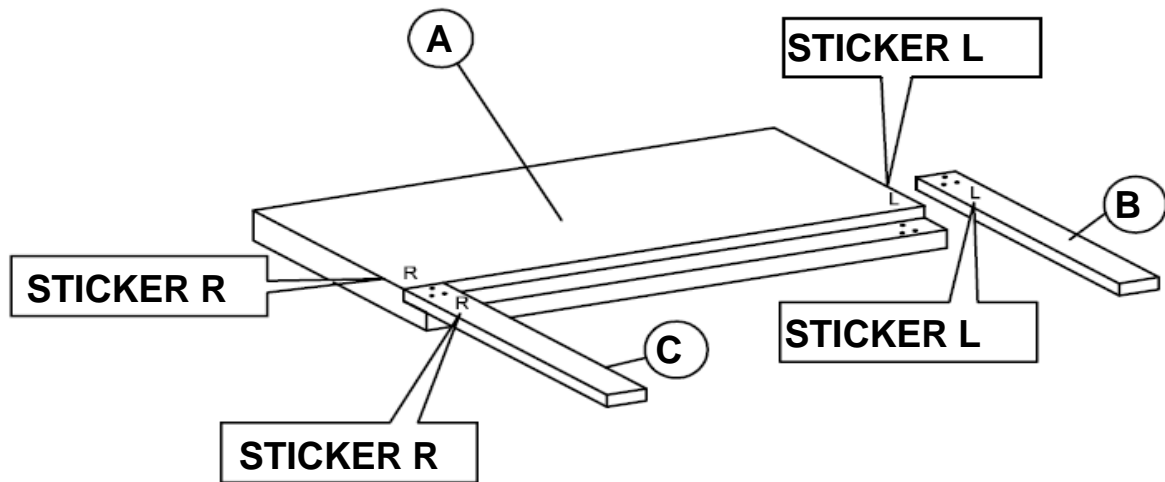

****BACK VIEW**

IF PURCHASE HEADBOARD ONLY, SKIP BELOW STEPS

STEP 2

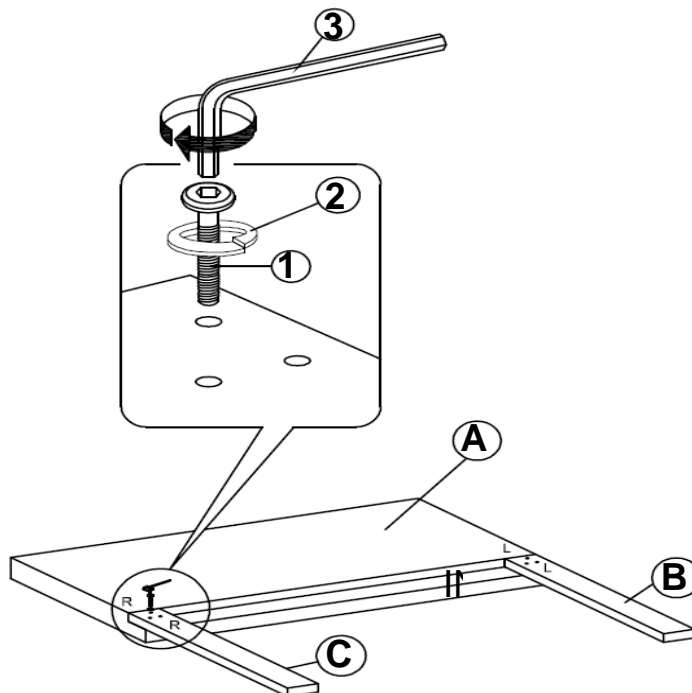

****BACK VIEW**

IF PURCHASE HEADBOARD ONLY, SKIP BELOW STEPS

ASSEMBLY INSTRUCTIONS

STEP 3

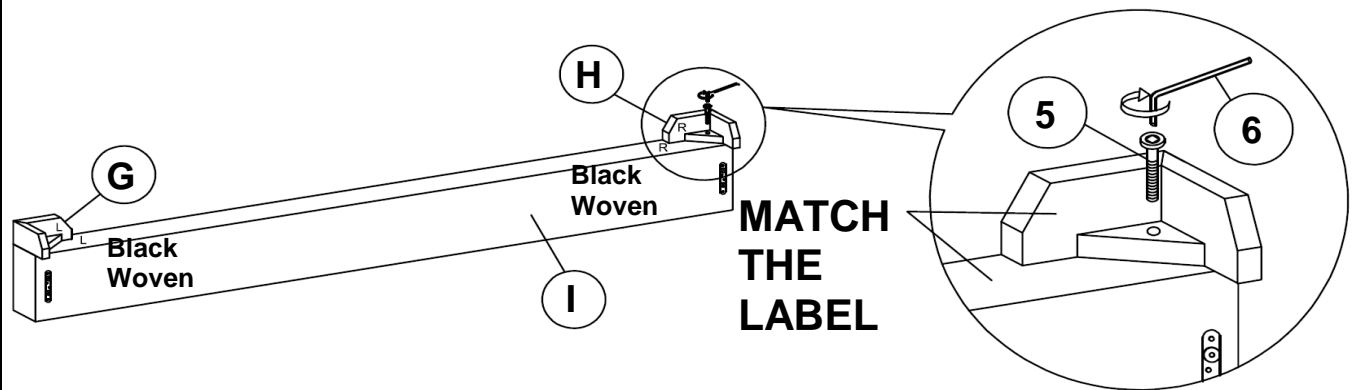

STEP 4

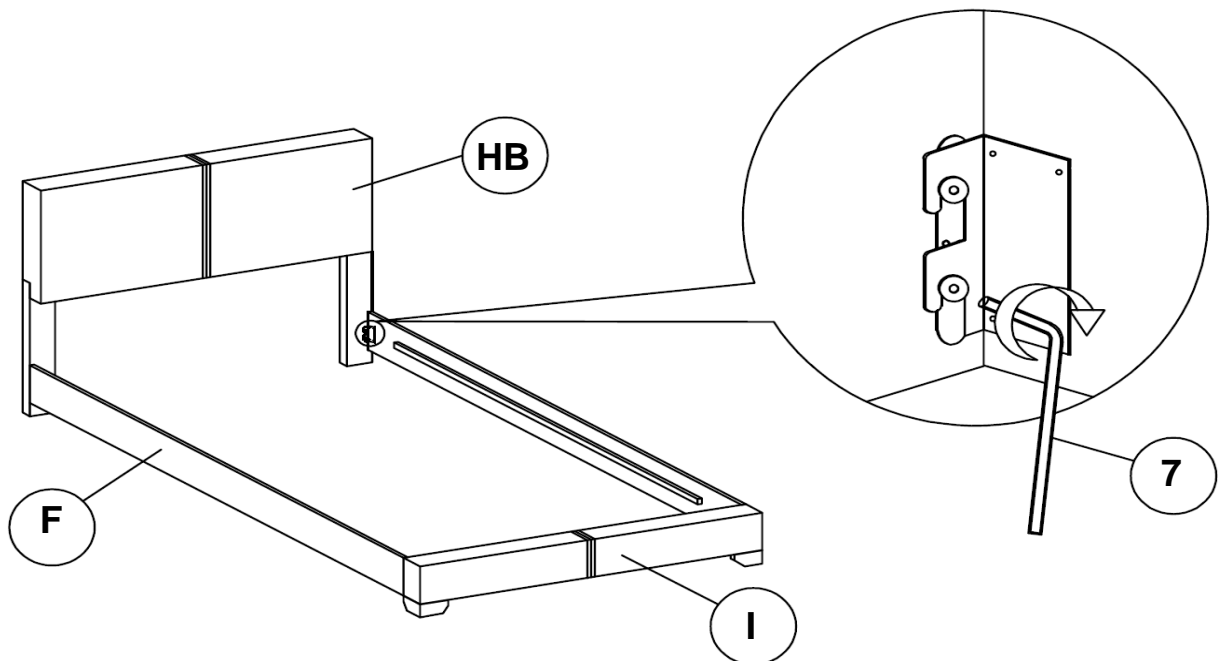

STEP 5

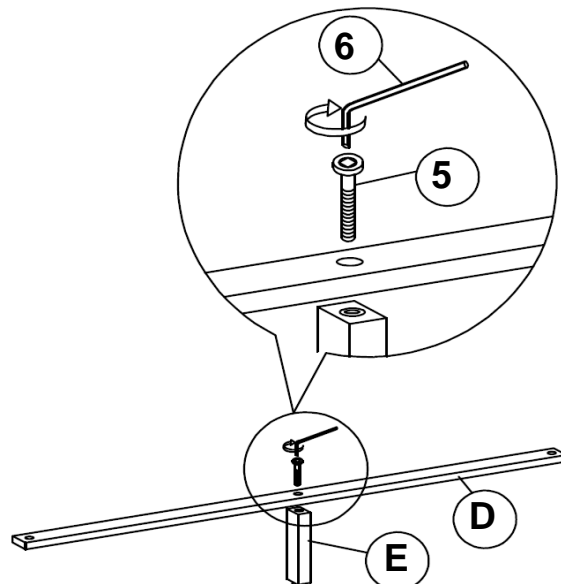

ITEM: **300261Q (B1&B2)**



ASSEMBLY INSTRUCTIONS

STEP 6

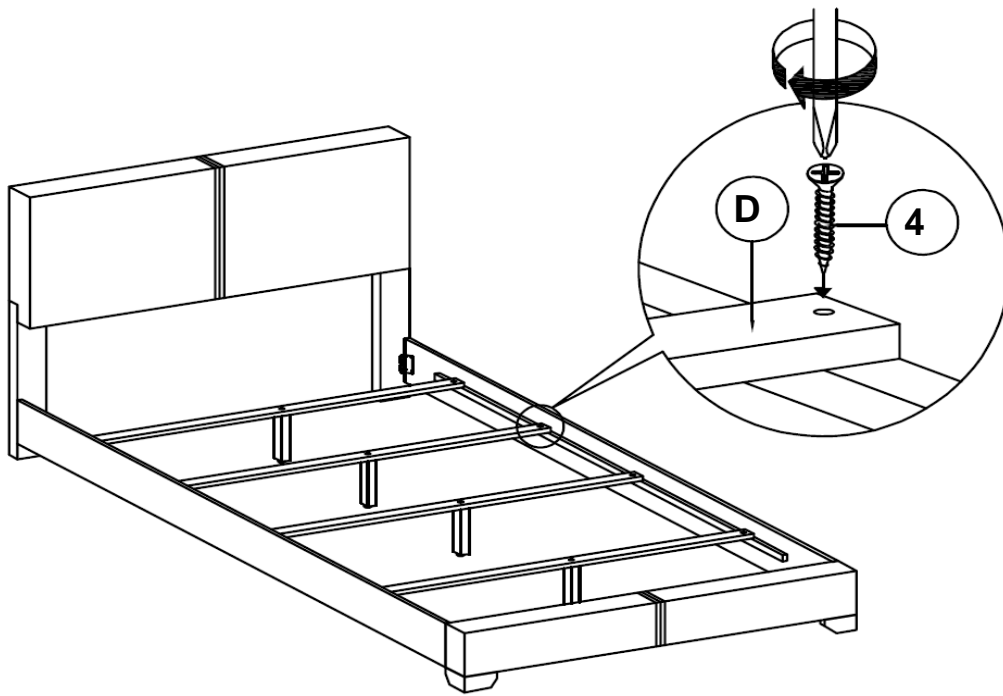

STEP 7
COMPLETE

