

ASSEMBLY INSTRUCTIONS
COASTER FINE FURNITURE

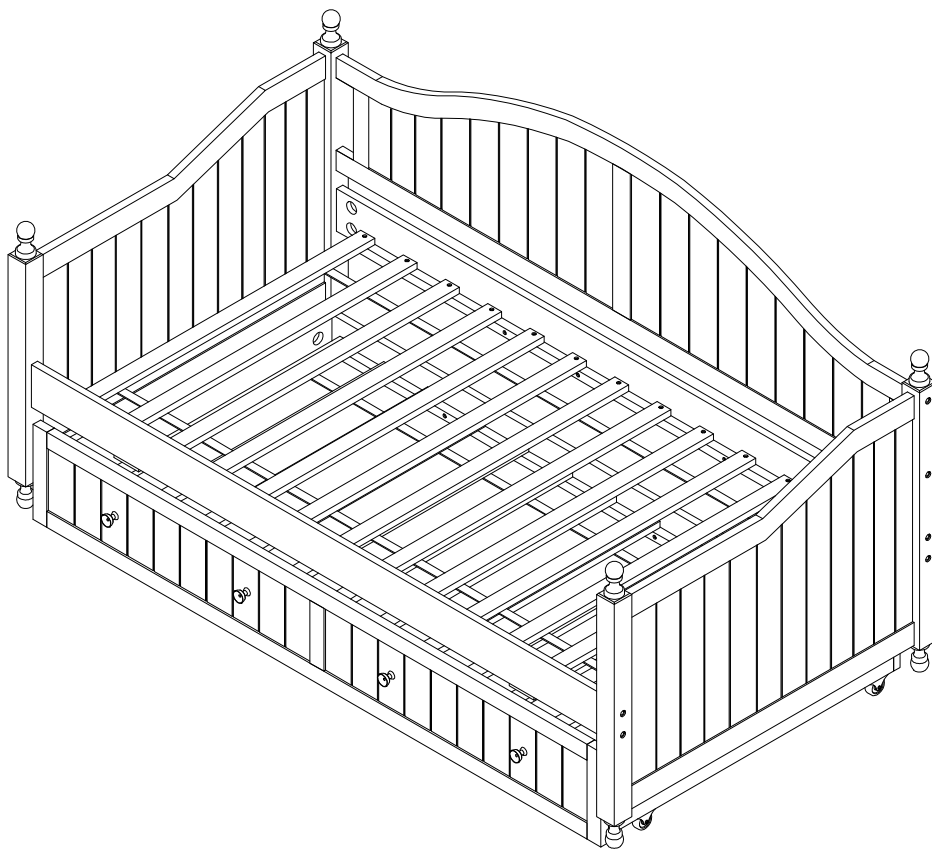

Fine Furniture for every stage of life

301053 (B1-B3)
Day Bed

ITEM: 301053 (B1-B3)

ASSEMBLY INSTRUCTIONS

ASSEMBLY TIPS:

1. Remove hardware from box and sort by size.
2. Please check to see that all hardware and parts are present prior to start of assembly.
3. Please follow attached instructions in the same sequence as numbered to assure fast & easy assembly.



WARNING!

1. Don't attempt to repair or modify parts that are broken or defective. Please contact the store immediately.
2. This product is for home use only and not intended for commercial establishments.

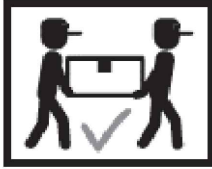





ASSEMBLY TIME

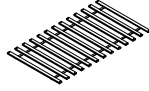

30 MINUTES

PARTS IDENTIFICATION





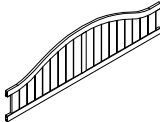

B1 (BOX 1)

A	RIGHT SIDE PANEL		1PC	D	BUN FOOT		4PCS
B	LEFT SIDE PANEL		1PC	E	ROLL SLAT (13PCS)		1 SET
C	FINIAL		4PCS				

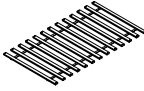
B2 (BOX 2)

F	BACK PANEL		1PC	H	BACK RAIL		1PC
G	FRONT RAIL		1PC				

B3 (BOX 3)

I	TRUNDLE ROLL SLAT (13PCS)		1 SET	L	TRUNDLE RIGHT SIDE PANEL WITH CASTER		1PC
J	TRUNDLE FRONT PANEL		1PC	M	TRUNDLE LEFT SIDE PANEL WITH CASTER		1PC
K	TRUNDLE BACK PANEL		1PC	N	KNOB WITH BOLT		4SETS

NOTE:

Phillips head screw driver is required in the assembly process; however, manufacturer does not provide this item.

ITEM: 301053 (B1-B3)

ASSEMBLY INSTRUCTIONS

ASSEMBLY TIPS:

1. Remove hardware from box and sort by size.
2. Please check to see that all hardware and parts are present prior to start of assembly.
3. Please follow attached instructions in the same sequence as numbered to assure fast & easy assembly.



WARNING!

1. Don't attempt to repair or modify parts that are broken or defective. Please contact the store immediately.
2. This product is for home use only and not intended for commercial establishments.

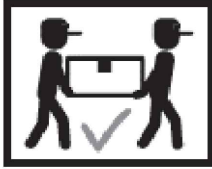





ASSEMBLY TIME







30 MINUTES

HARDWARE IDENTIFICATION

Z - B2 (BOX2) - HARDWARE PACK IS LOCATED IN 301053(B2)

1	BOLT (1/4 x 110mm Φ 15L4 - BLK)		12PCS	4	WOOD DOWEL (10 x 40mm)		8PCS
2	HALF ROUND NUT (1/4 x 22mm - BLK)		12PCS	5	ALLEN WRENCH (4 x 57MM - BLK)		1PC
3	FLAT HEAD SREW (4 x 30mm - BLK)		26PCS				

Z - B3 (BOX3) - HARDWARE PACK IS LOCATED IN 301053(B3)

6	LONG BOLT (1/4 x 50mm Φ 12L4 - BLK)		2PCS	10	WOOD DOWEL (10 x 40mm)		4PCS
7	HALF ROUND NUT (1/4 x 22mm - BLK)		2PCS	11	ALLEN WRENCH (4 x 57MM - BLK)		1PC
8	SHORT BOLT (1/4 x 35mm Φ 12L4 - BLK)		4PCS				
9	FLAT HEAD SCREW (4 x 30mm - BLK)		26PCS				

NOTE:

Phillips head screw driver is required in the assembly process; however, manufacturer does not provide this item.

STEP 1

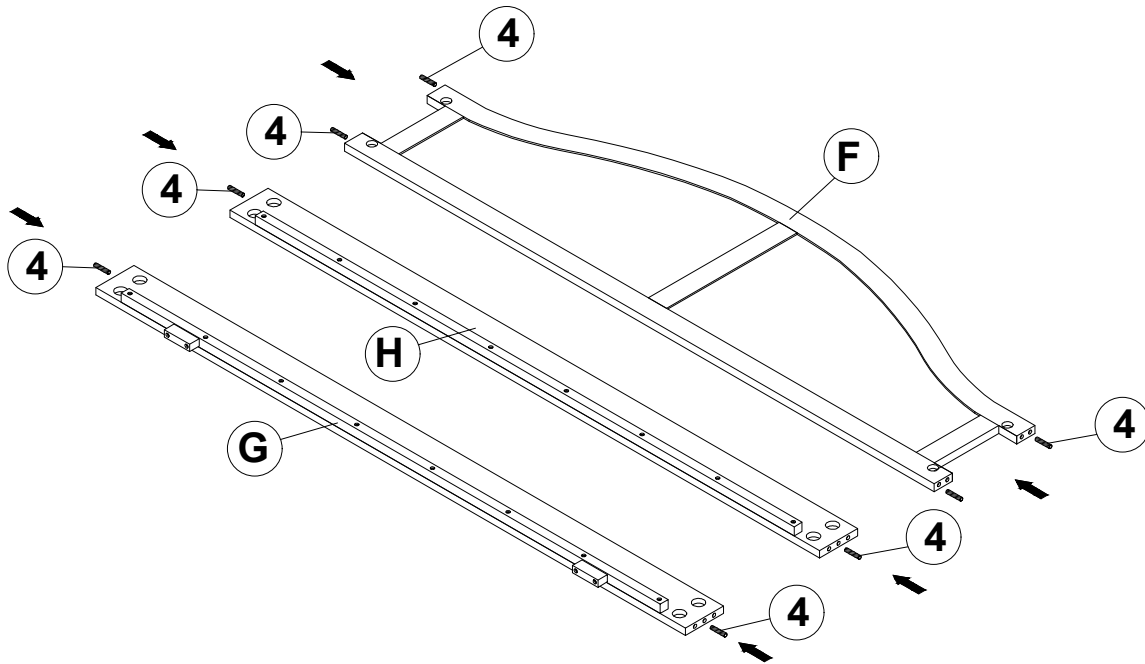

STEP 2

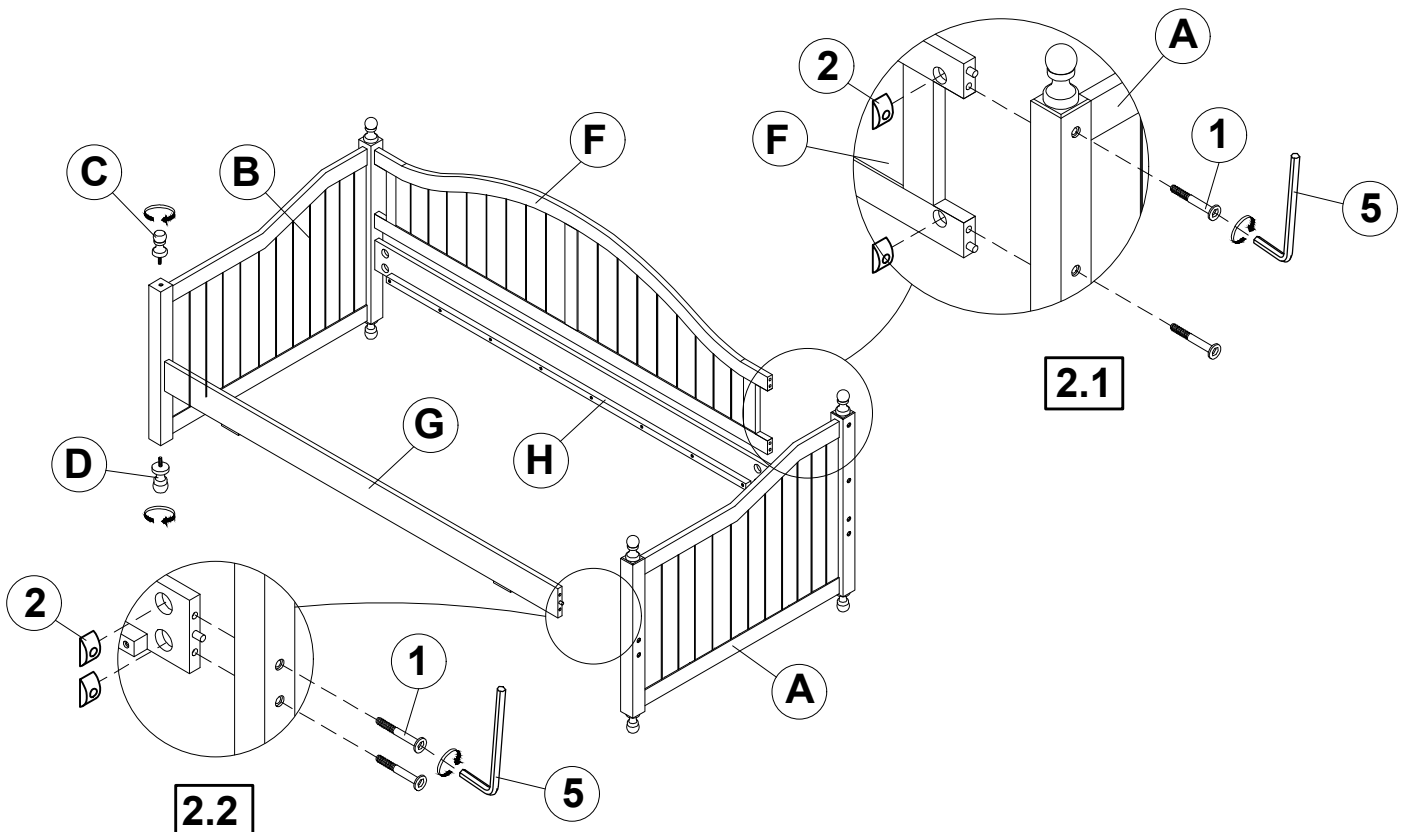

STEP 3

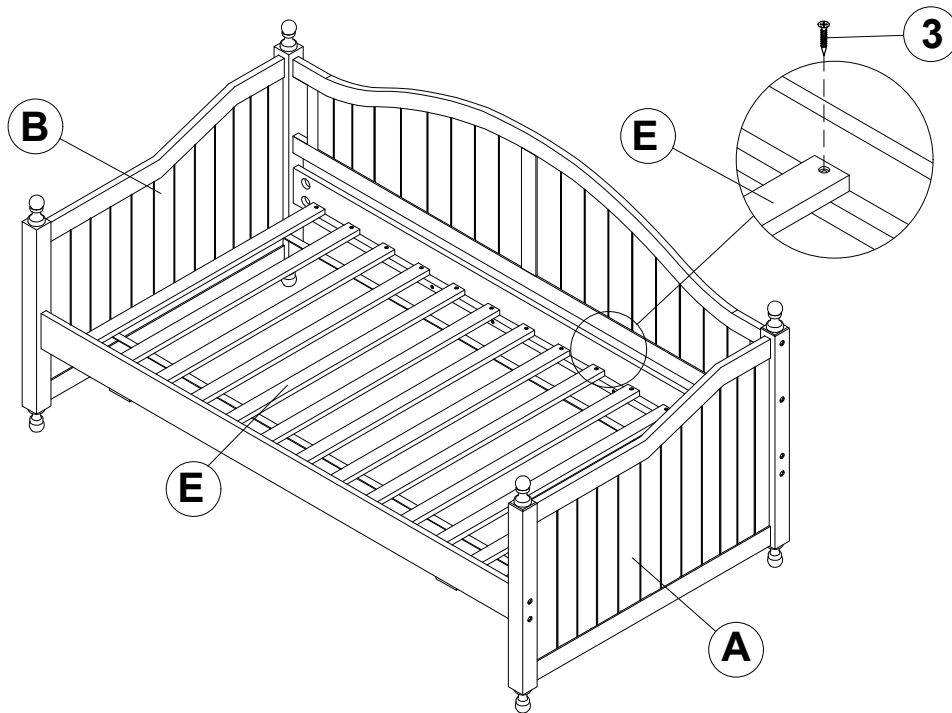

STEP 4

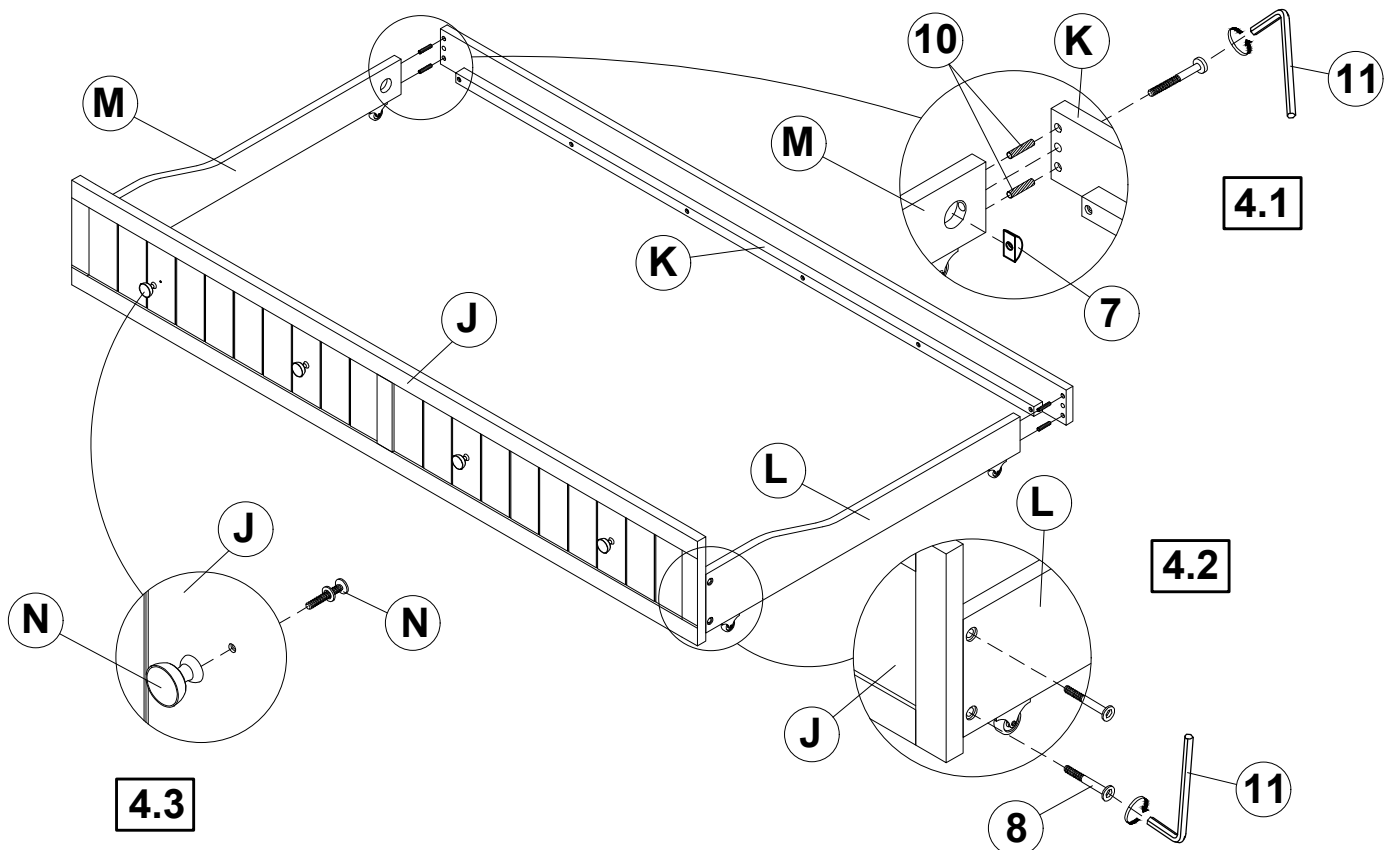

ITEM: **301053 (B1-B3)**

ASSEMBLY INSTRUCTIONS



STEP 5

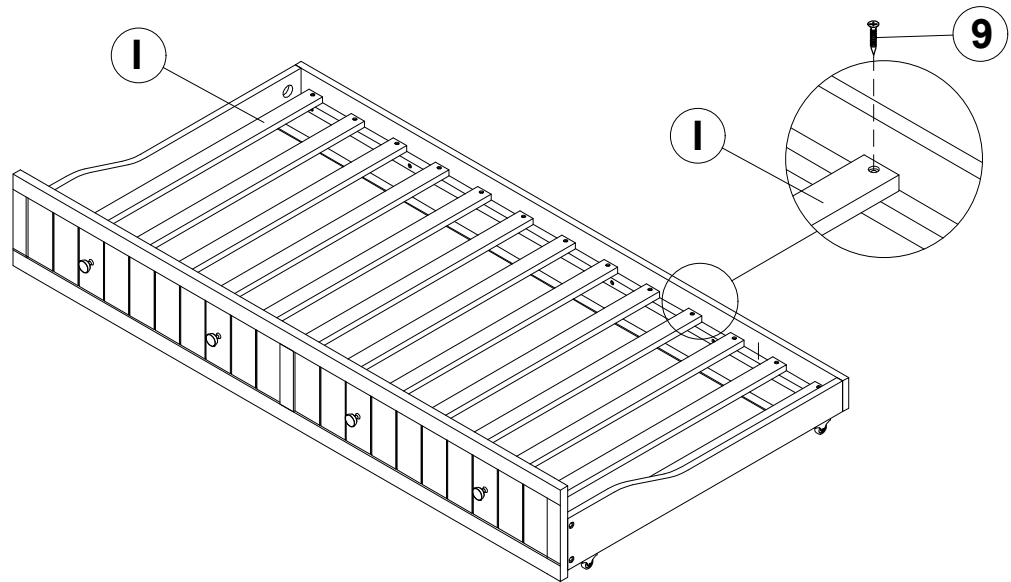

STEP 6

COMPLETE

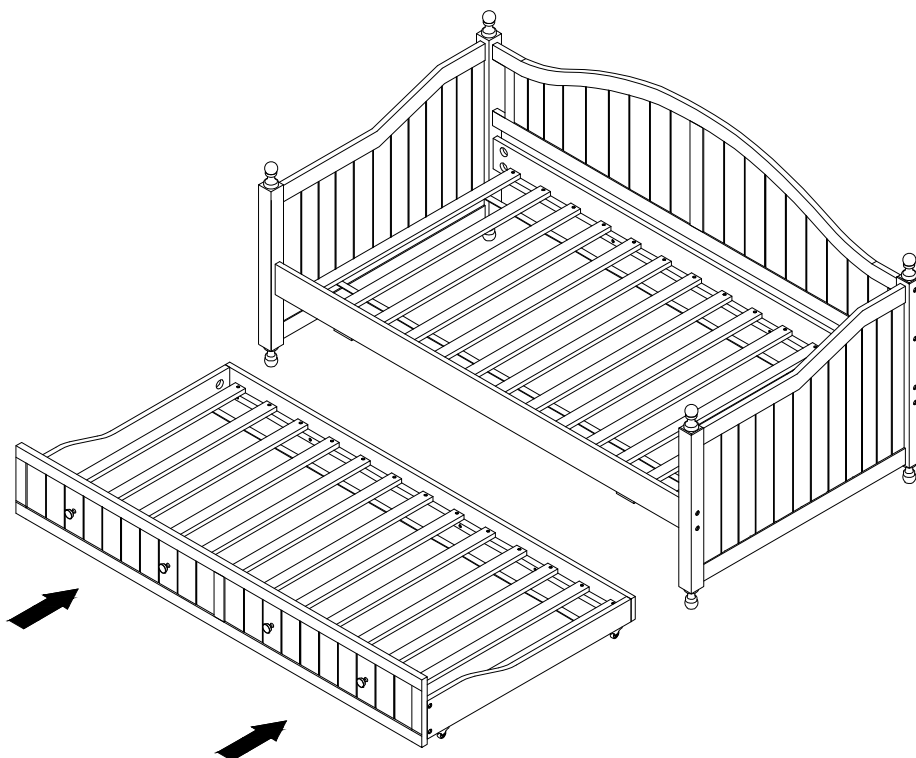

ITEM: 301053 (B1-B3)

ASSEMBLY INSTRUCTIONS

INNER SIZE: 79.97" X 39.96"

TRUNDLE INNER SIZE: 75.20" X 39.96"

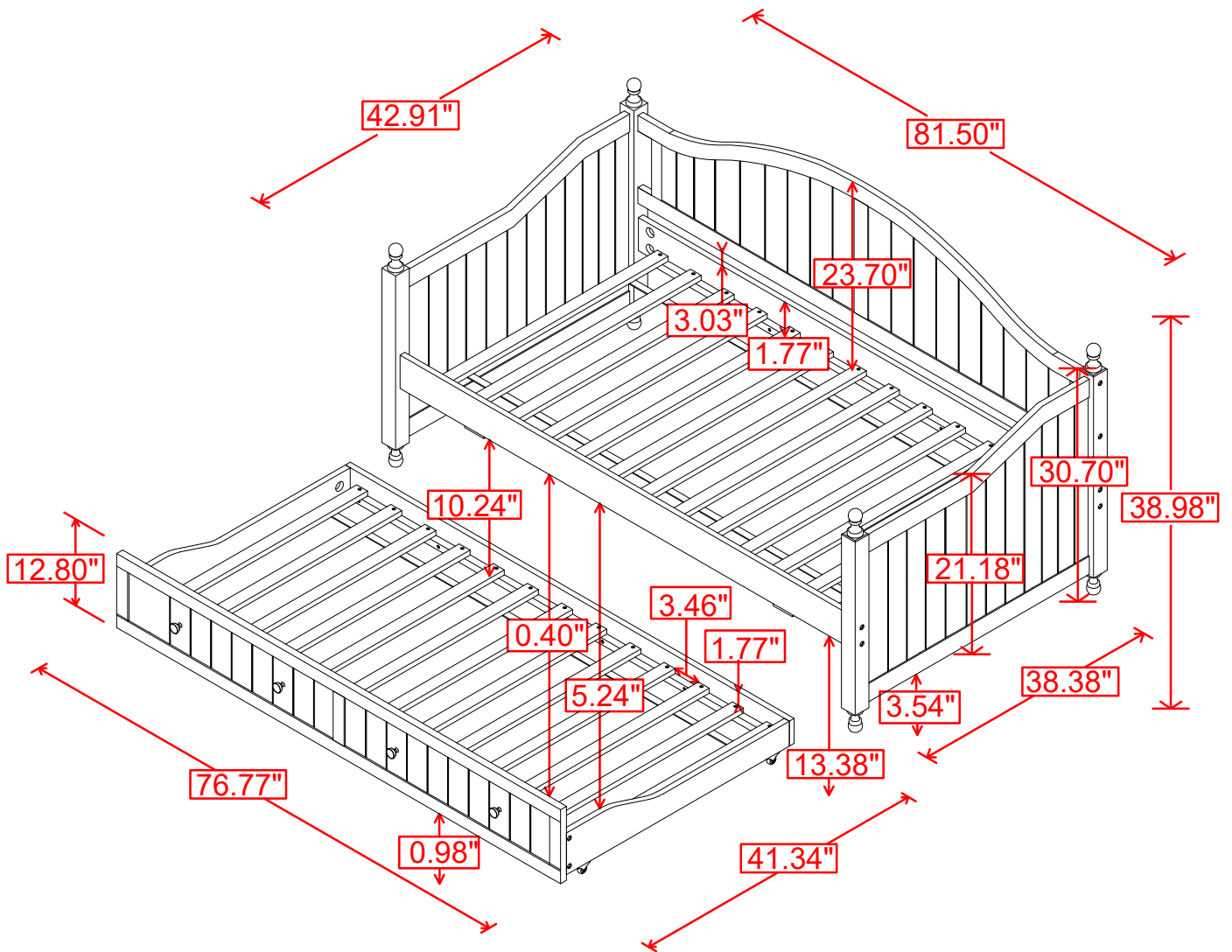

Note: Dimension tolerance $\pm 5\%$