

ASSEMBLY INSTRUCTIONS
COASTER FINE FURNITURE

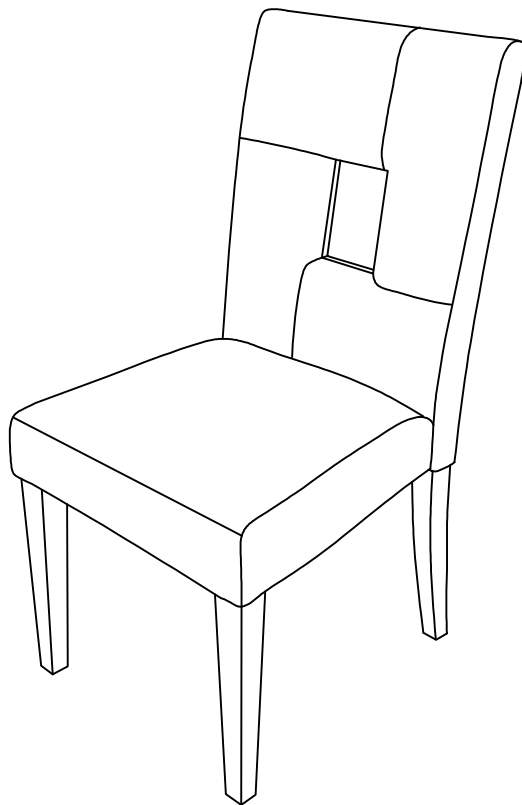

Fine Furniture for every stage of life

106656
Dining Chair

REVISION 0 : 11/07/2015
REVISION 1 : 01/03/2019
REVISION 2 : 06/06/2019
REVISION 3 : 09/23/2019

ITEM:106656



ASSEMBLY INSTRUCTIONS

ASSEMBLY TIPS:

1. Remove hardware from box and sort by size.
2. Please check to see that all hardware and parts are present prior start of assembly.
3. Please follow attached instructions in the same sequence as numbered to assure fast & easy assembly.



WARNING!

1. Don't attempt to repair or modify parts that are broken or defective. Please contact the store immediately.
2. This product is for home use only and not intended for commercial establishment.





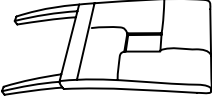
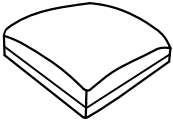
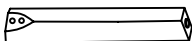

ASSEMBLY TIME

15 MINUTES

PARTS IDENTIFICATION

A	CHAIR BACK		1PC
B	SEAT		1PC
C	FRONT LEGS		2PCS

Z HARDWARE IDENTIFICATION

NO	DESCRIPTION	FIGURE	Q' TY
1	ØALLEN KEY 5mm		1PC
2	ØLOCK WASHER 5/16"		10PCS
3	ØFLAT WASHER 5/16"		10PCS
4	ØBOLT 5/16X2"		2PCS
5	ØBOLT 5/16X2-1/4"		4PCS
6	ØBOLT 5/16X3-1/2"		4PCS

STEP: 1

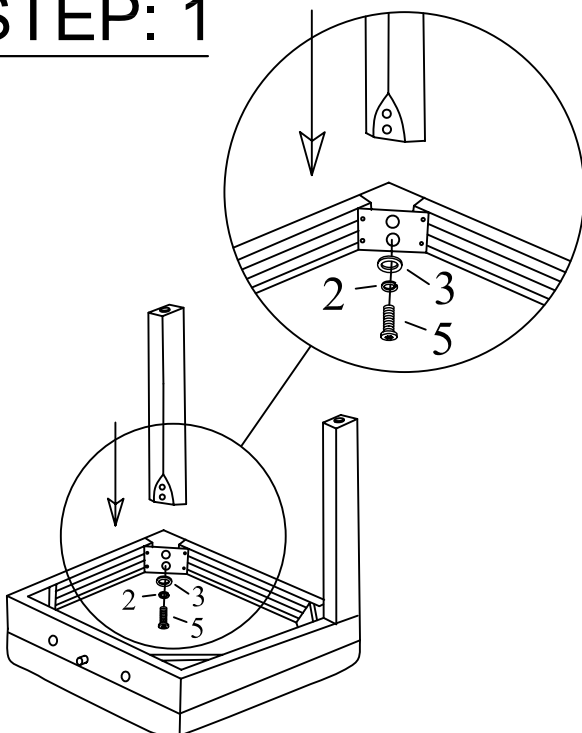

STEP: 2

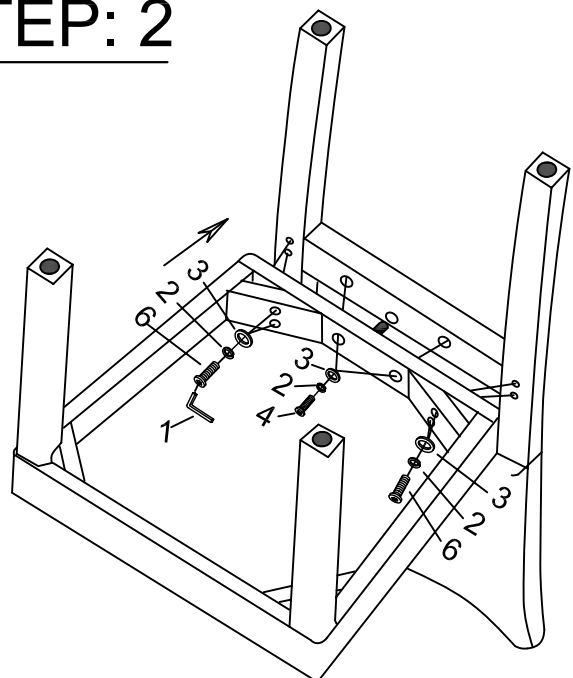

ITEM:106656



ASSEMBLY INSTRUCTIONS

