

***ASSEMBLY INSTRUCTION***  
***COASTER FINE FURNITURE***

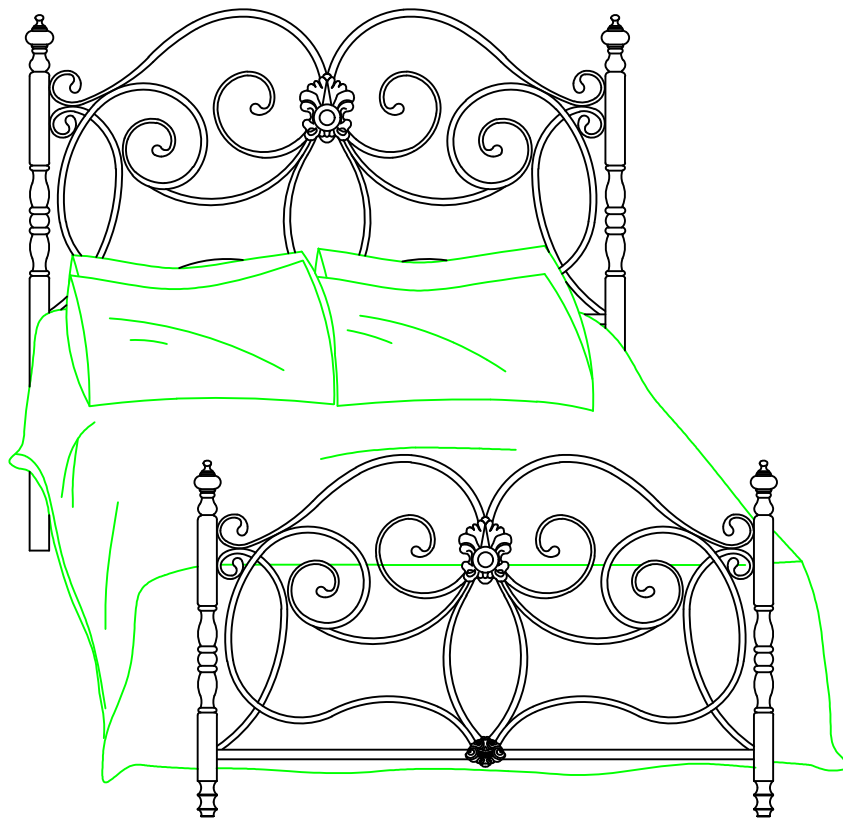

*Fine Furniture for every stage of life*

**300258 (KE)**  
***King Size Metal Bed***

REVISION 0 : 07/25/2019  
REVISION 1 : 01/04/2020  
REVISION 1 : 03/16/2020

# ITEM:300258 (KE)



## ASSEMBLY INSTRUCTIONS

### ASSEMBLY TIPS:

- 1 . Remove hardware from box and sort by size.
- 2 . Please check to see that all hardware and parts are present prior to start of assembly.
- 3 . Please follow attached instruction in the same sequence as numbered assure fast & easy assembly.

### WARNING !





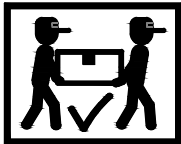

- 1 . Don't attempt to repair or modify parts that are broken or defective . Please contact the store immediately.
- 2 . This product is for home use only and not intended for commercial establishment.









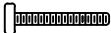

ASSEMBLY TIME

5 MINUTES

## PARTS IDENTIFICATION

A	HEADBOARD		1PC	C	HEADBOARD LEG EXTENSION		2PCS
B	FOOTBOARD		1PC	D	FINIAL		4PCS

## Z HARDWARE IDENTIFICATION

1	LONG BOLT (1/4"*2-3/4")		4PCS	6	LOCK WASHER (1/4"*11mm)		8PCS
2	MEDIUM BOLT (1/4"*1")		4PCS	7	NUT (1/4"*10mm)		4PCS
3	SHORT BOLT (1/4"*3/4")		4PCS	8	HEX WRENCH (4mm)		1PC
4	PLASTIC WASHER (1/4"*24mm)		8PCS	9	OPEN WRENCH (10mm)		1PC
5	METAL WASHER (1/4"*16mm)		12PCS				

### NOTE:

Philips head screw drivew driver is required in the assembly process; manufacturer does not provide this item.

# ITEM:300258 (KE)

## ASSEMBLY INSTRUCTIONS

### STEP 1

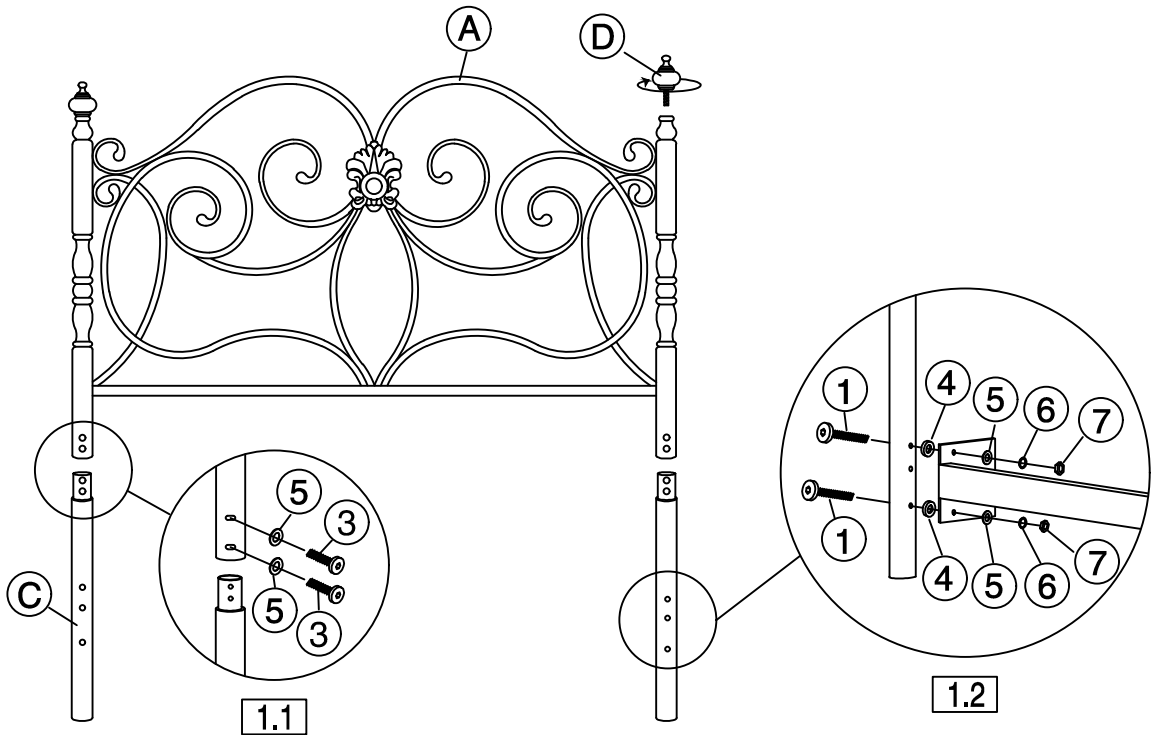

### STEP 2

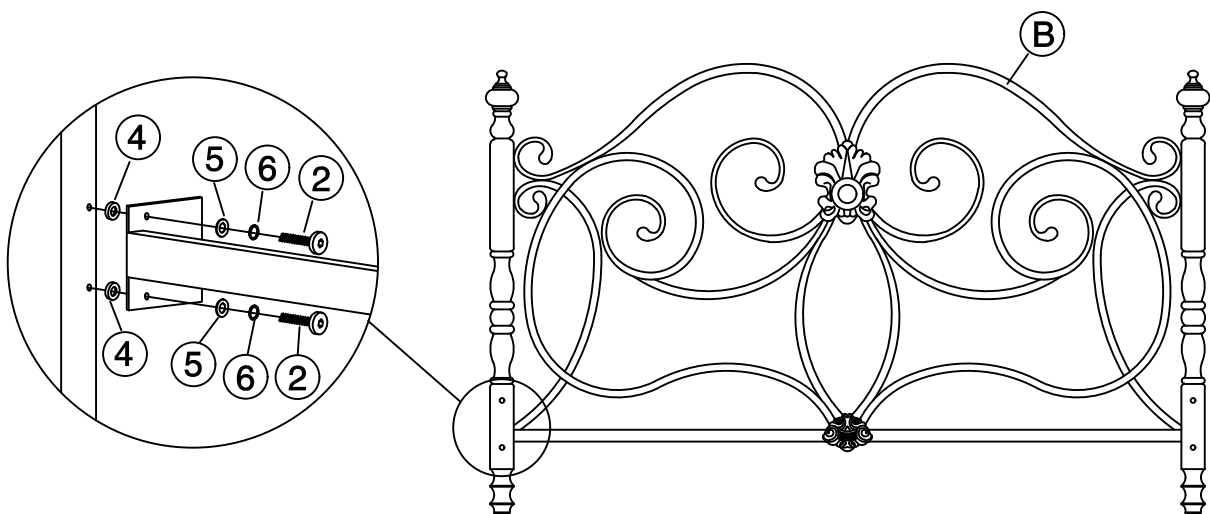

ITEM:300258 (KE)

