

ASSEMBLY INSTRUCTIONS
COASTER FINE FURNITURE

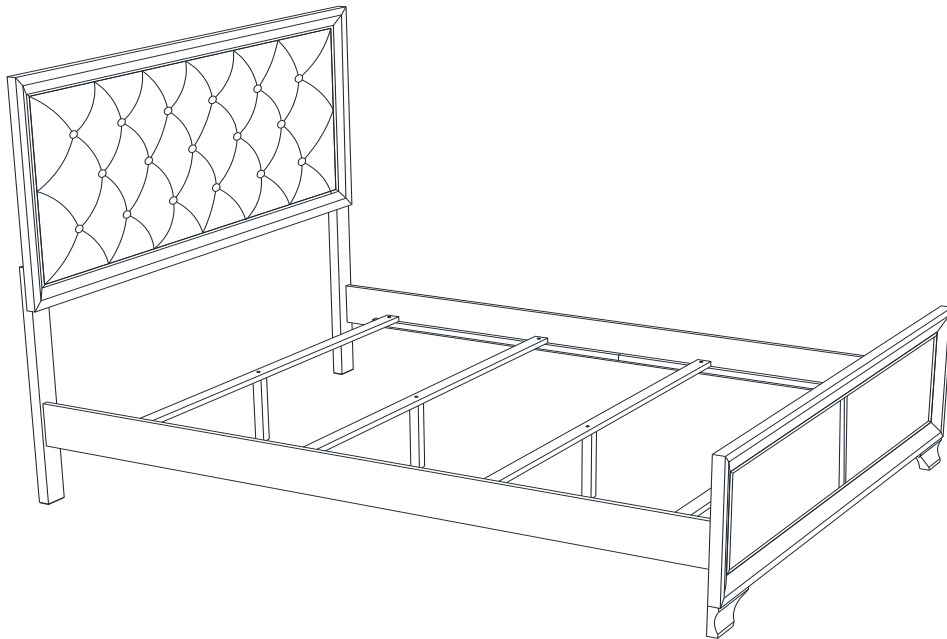

Fine Furniture for every stage of life

205291Q (B1&B2)
Queen Bed

REVISION 0 : 05/10/2017
REVISION 1 : 07/12/2017
REVISION 2 : 02/05/2020

ITEM: 205291Q (B1&B2)



ASSEMBLY INSTRUCTIONS

ASSEMBLY TIPS:

1. Remove hardware from box and sort by size.
2. Please check to see that all hardware and parts are present prior to start of assembly.
3. Please follow attached instructions in the same sequence as numbered to assure fast & easy assembly.



WARNING!

1. Don't attempt to repair or modify parts that are broken or defective. Please contact the store immediately.
2. This product is for home use only and not intended for commercial establishments.



ASSEMBLY TIME

20 MINUTES

PARTS IDENTIFICATION

B1 (BOX 1)

A HEADBOARD PANEL

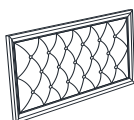

1PC

B FOOTBOARD

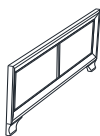

1PC

C RIGHT HEADBOARD LEG

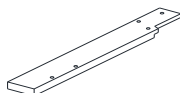

1PC

D LEFT HEADBOARD LEG

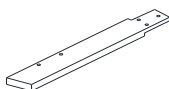

1PC

E BED SLAT

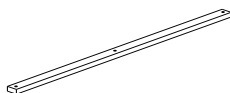

4PCS

F BED SLAT SUPPORT WITH LEVELER



4PCS

B2 (BOX 2)

G BED RAIL

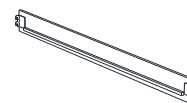

2PCS

HB 205291Q(B1) FROM BOX 1 HEADBOARD COMPLETE

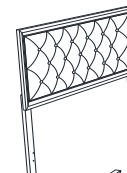

1PC

B 205291Q(B1) FROM BOX 1 FOOTBOARD

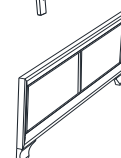

1PC

ITEM: 205291Q (B1&B2)

ASSEMBLY INSTRUCTIONS

ASSEMBLY TIPS:

1. Remove hardware from box and sort by size.
2. Please check to see that all hardware and parts are present prior to start of assembly.
3. Please follow attached instructions in the same sequence as numbered to assure fast & easy assembly.









WARNING!

1. Don't attempt to repair or modify parts that are broken or defective. Please contact the store immediately.
2. This product is for home use only and not intended for commercial establishments.

HARDWARE IDENTIFICATION

Z-B1 (BOX 1) - HARDWARE PACK IS LOCATED IN 205291Q (B1)

1	BOLT (M6 x 30mm - BLK)		6PCS
2	LOCK WASHER (1/4" - BLK)		6PCS
3	FLAT WASHER (1/4" ID x 13mm - BLK)		6PCS
4	SMALL ALLEN WRENCH (M4 x 60mm - BLK)		1PC
5	BIG ALLEN WRENCH (M5 x 65mm - BLK)		1PC
6	FLAT HEAD SCREW (M4 x 32mm - RBW)		8PCS

NOTE:

Phillips head screw driver is required in the assembly process; however, manufacturer does not provide this item.

ASSEMBLY INSTRUCTIONS

STEP 1

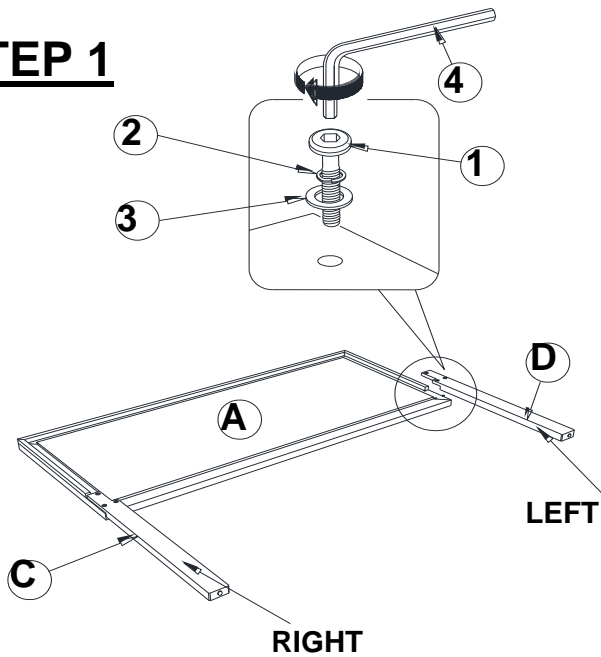

****BACK VIEW****

Note : Please put item on soft surface.

Note : Please take note of the marking sticker (L&R) on the leg.

STEP 2

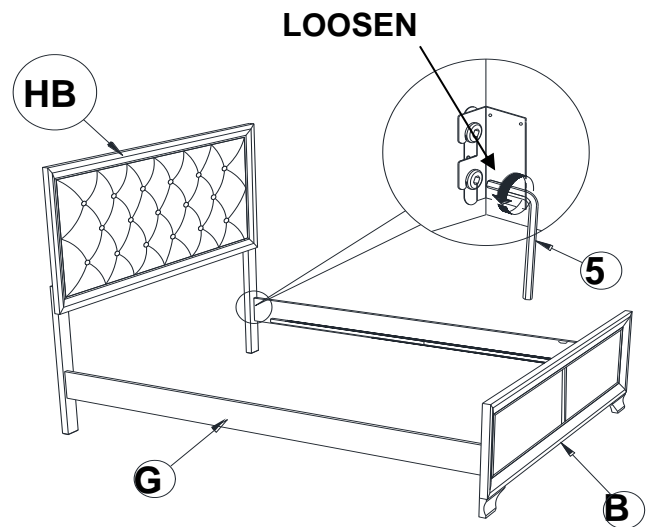

STEP 3

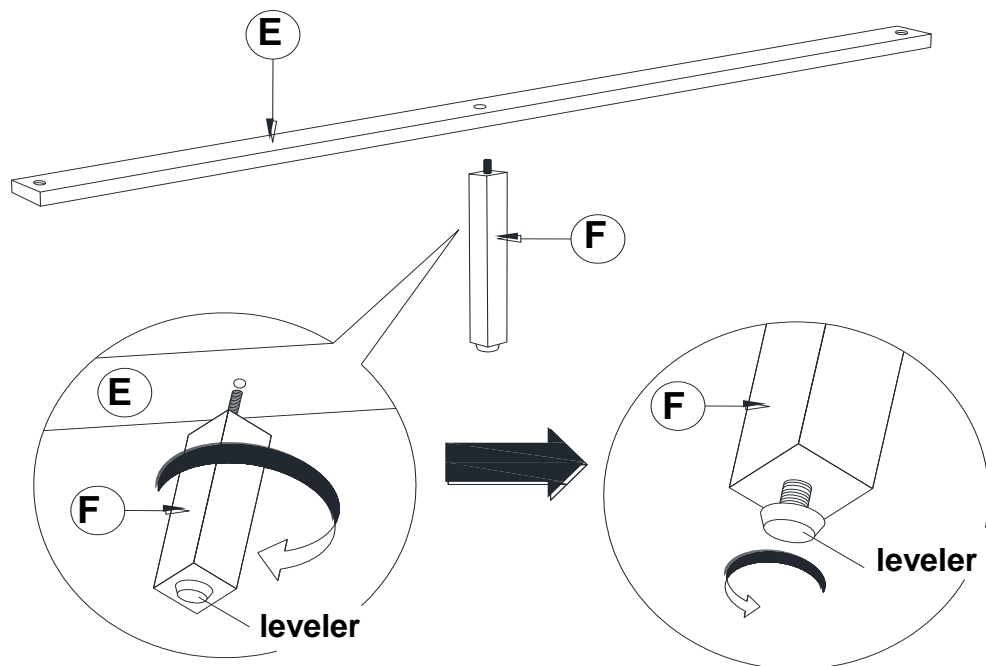

ASSEMBLY INSTRUCTIONS

STEP 4

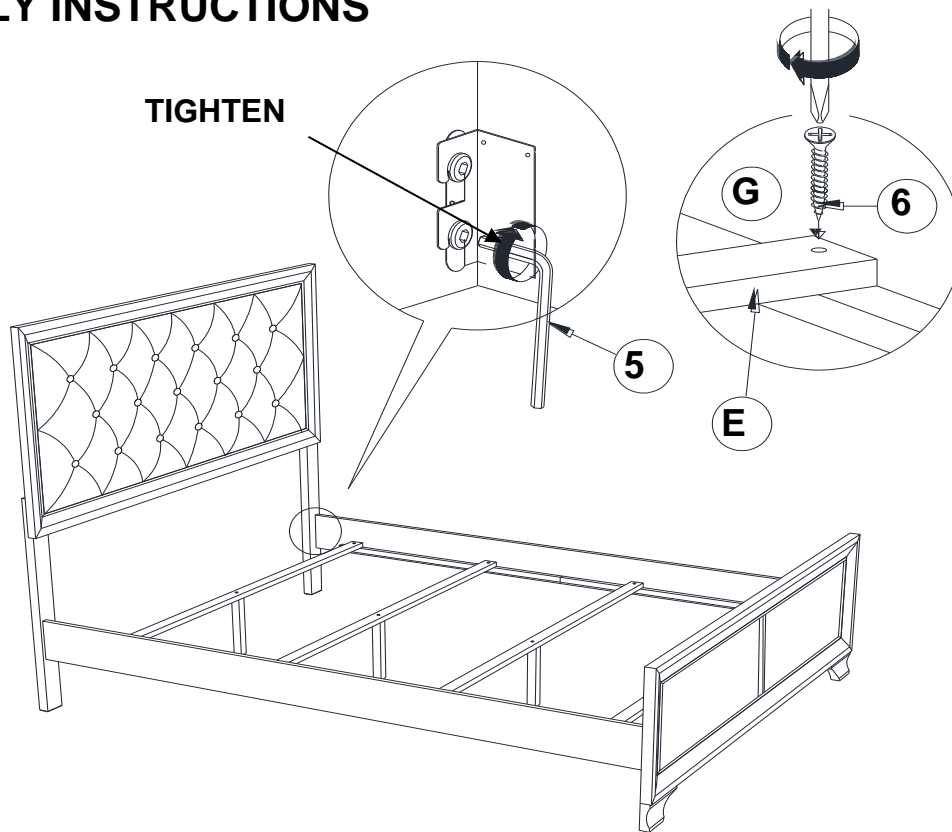

STEP 5
COMPLETE

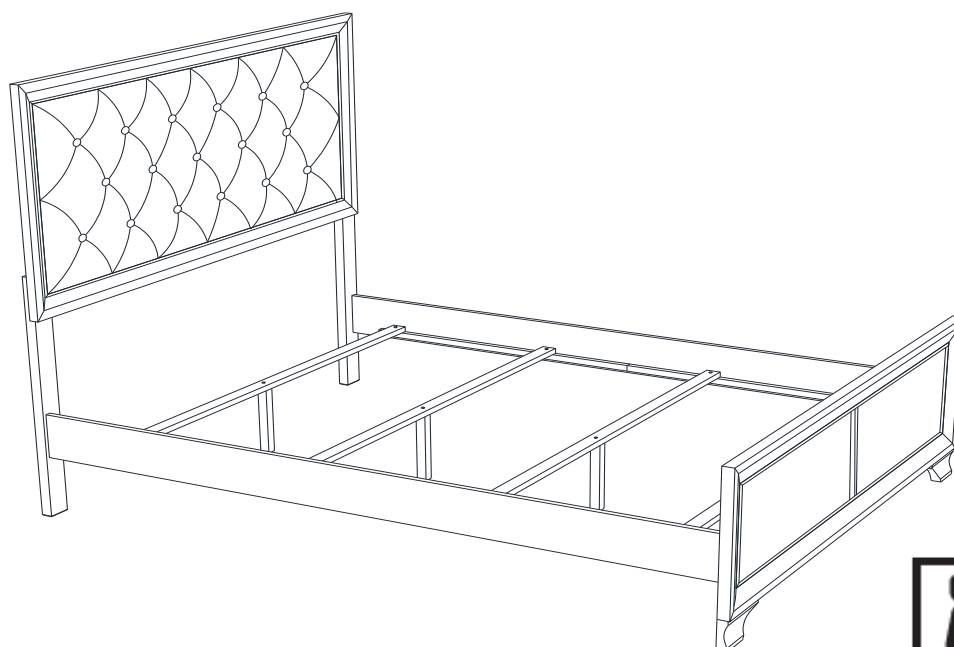

ITEM: 205291Q (B1&B2)

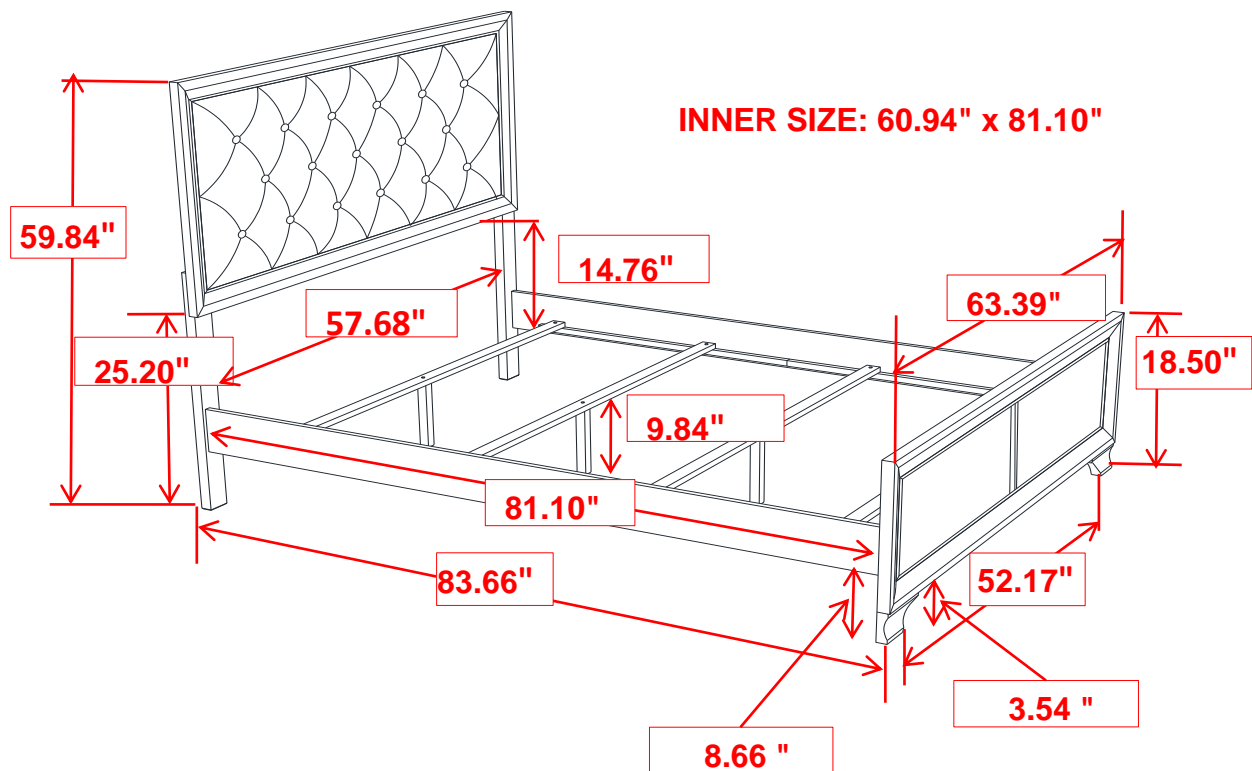

Note : Dimension tolerance $\pm 5\%$