

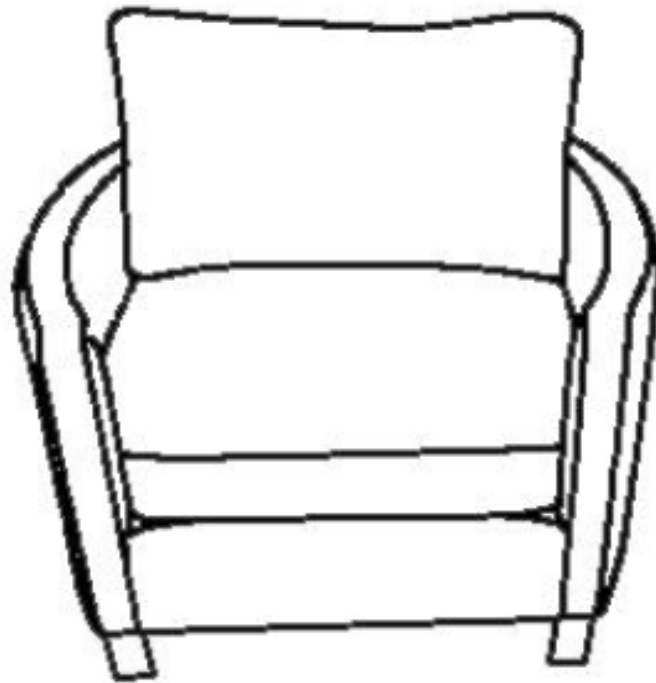

*ASSEMBLY INSTRUCTIONS
COASTER FINE FURNITURE*



**508823
CHAIR**

ITEM: 508823

ASSEMBLY INSTRUCTIONS



ASSEMBLY TIPS:

1. Remove hardware from box and sort by size.
2. Please check to see that all hardware and parts are present prior to start of assembly.
3. Please follow attached instructions in the same sequence as numbered to assure fast & easy assembly.



WARNING!

1. Don't attempt to repair or modify parts that are broken or defective. Please contact the store immediately.
2. This product is for home use only and not intended for commercial establishments.

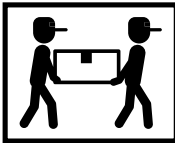

ASSEMBLY TIME

8 MINUTES

PARTS IDENTIFICATION

	PART NAME	FIGURE	QUANTITY
A	CHAIR BASE		1PC
B	LEG		2PCS
C	BACK CUSHION		1PC
E	SEAT CUSHION		1PC

HARDWARE IDENTIFICATION

1	BOLT		6PCS
2	WRENCH (M6-6mmX30mm)		1PC
3	FLAT WASHER (M6)		6PCS

ITEM: 508823

ASSEMBLY INSTRUCTIONS
STEP 1

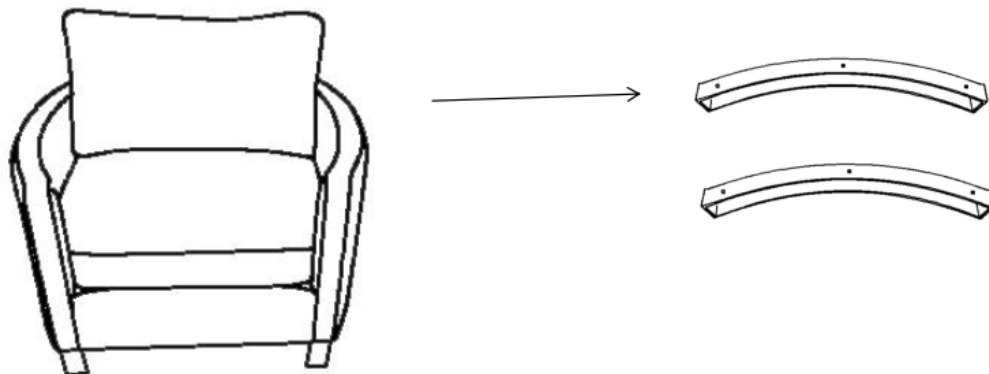

STEP 2

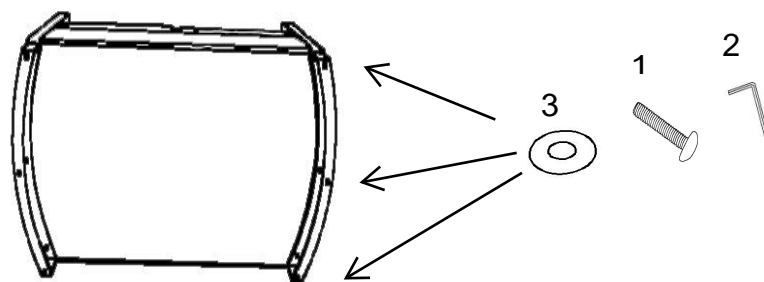

STEP 3

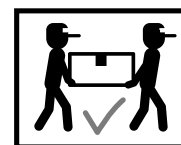
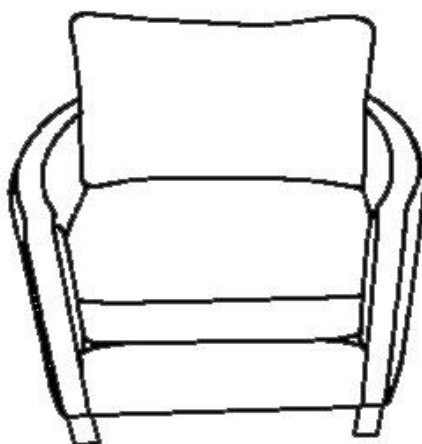

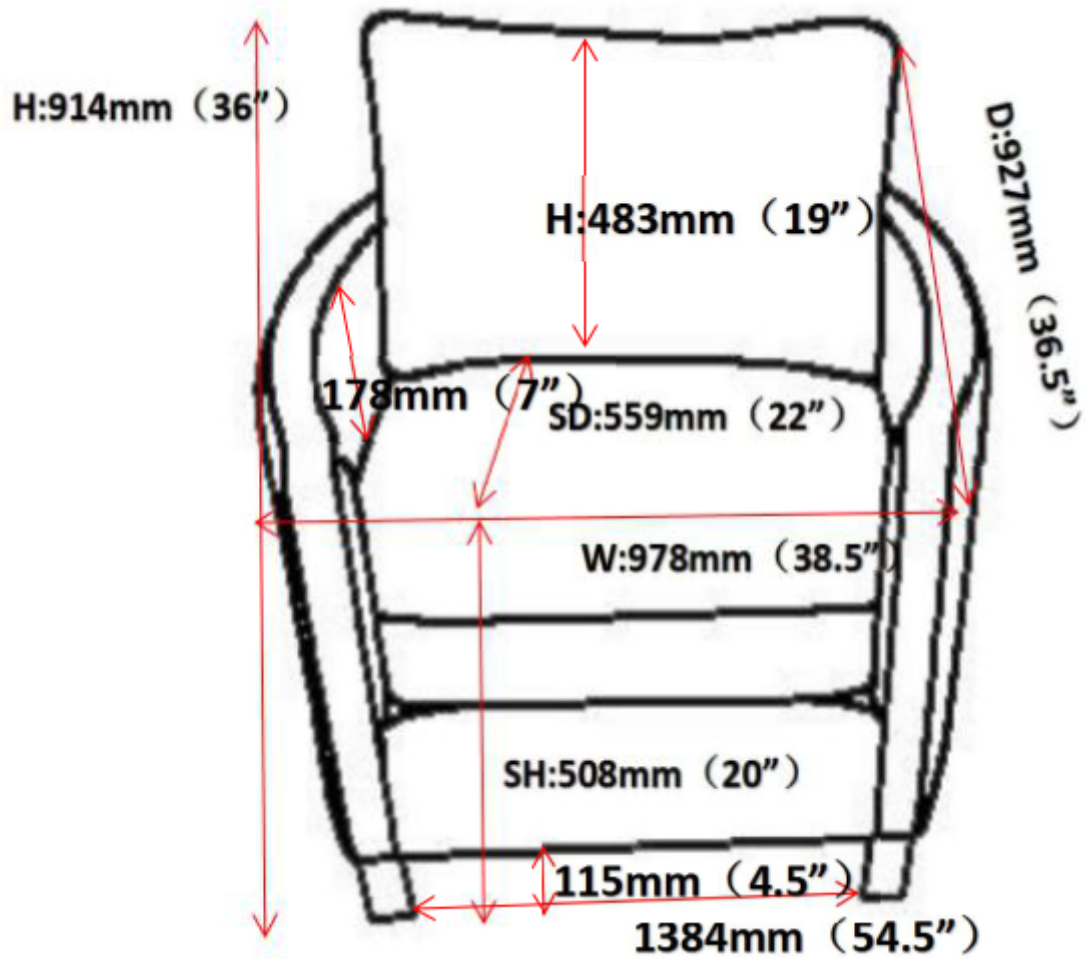

Note : Dimension tolerance $\pm 5\%$