

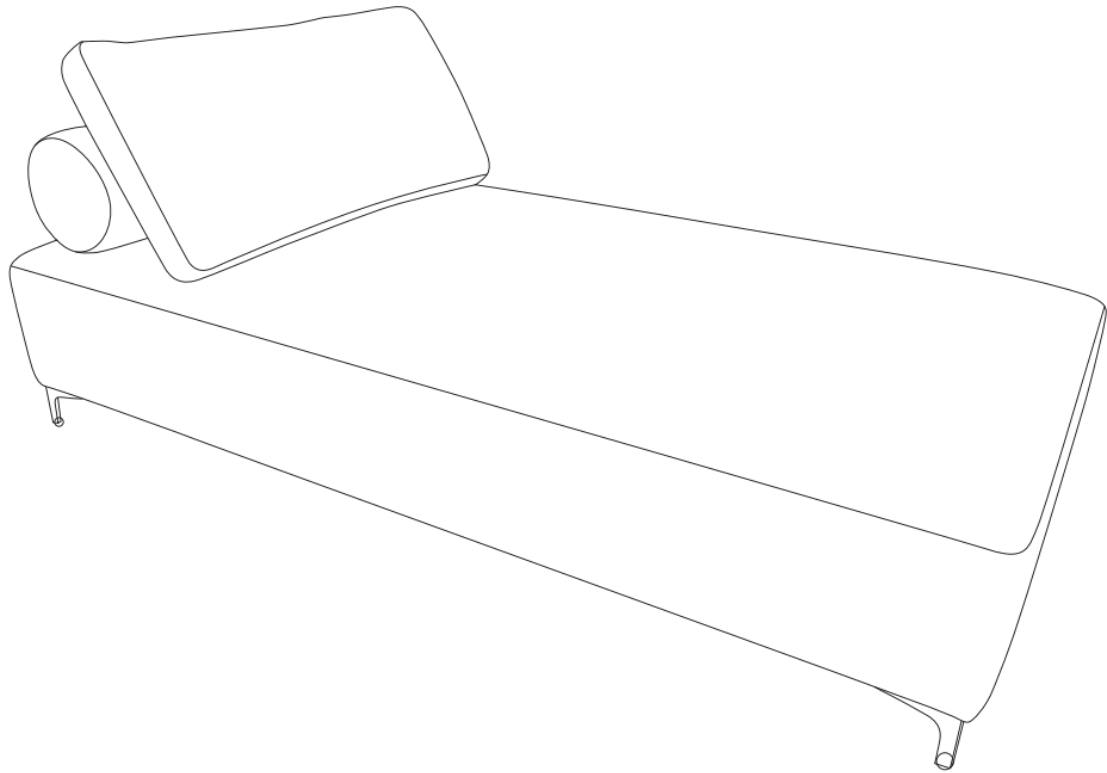

**ASSEMBLY INSTRUCTIONS
COASTER FINE FURNITURE**



Fine Furniture for every stage of life

**509060
CHAISE**

ITEM: 509060

ASSEMBLY INSTRUCTIONS



ASSEMBLY TIPS:

1. Remove hardware from box and sort by size.
2. Please check to see that all hardware and parts are present prior to start of assembly.
3. Please follow attached instructions in the same sequence as numbered to assure fast & easy assembly.



WARNING!

1. Don't attempt to repair or modify parts that are broken or defective. Please contact the store immediately.
2. This product is for home use only and not intended for commercial establishments.

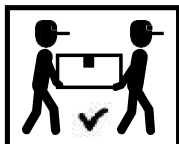

ASSEMBLY TIME

5 MINUTES

PARTS IDENTIFICATION

	FIGURE	PART NAME	QUANTITY
A		BASE	1PC
B		LEG	4PCS
C		MIDDLE LEG	1PC
D		PILLOW1	1PC
E		PILLOW2	1PC

Z HARDWARE IDENTIFICATION

	PART NAME	FIGURE	QUANTITY
1	BOLT 8*60mm		8PCS
2	FLAT WSAHER 8*18mm		8PCS
3	Allen wrench M8		1PC

ITEM: **509060**

ASSEMBLY INSTRUCTION



FINE FURNITURE

STEP 1

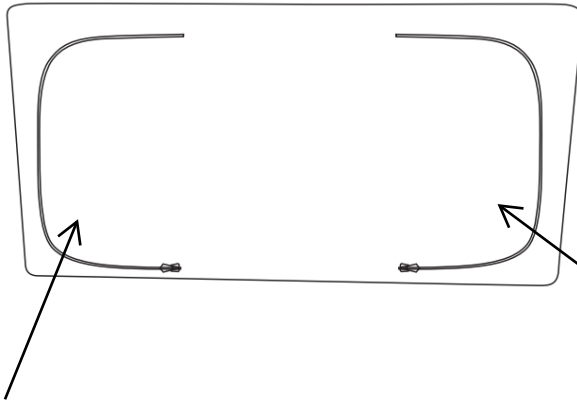

LEGS AND PILLOW1 INSIDE

PILLOW2 INSIDE

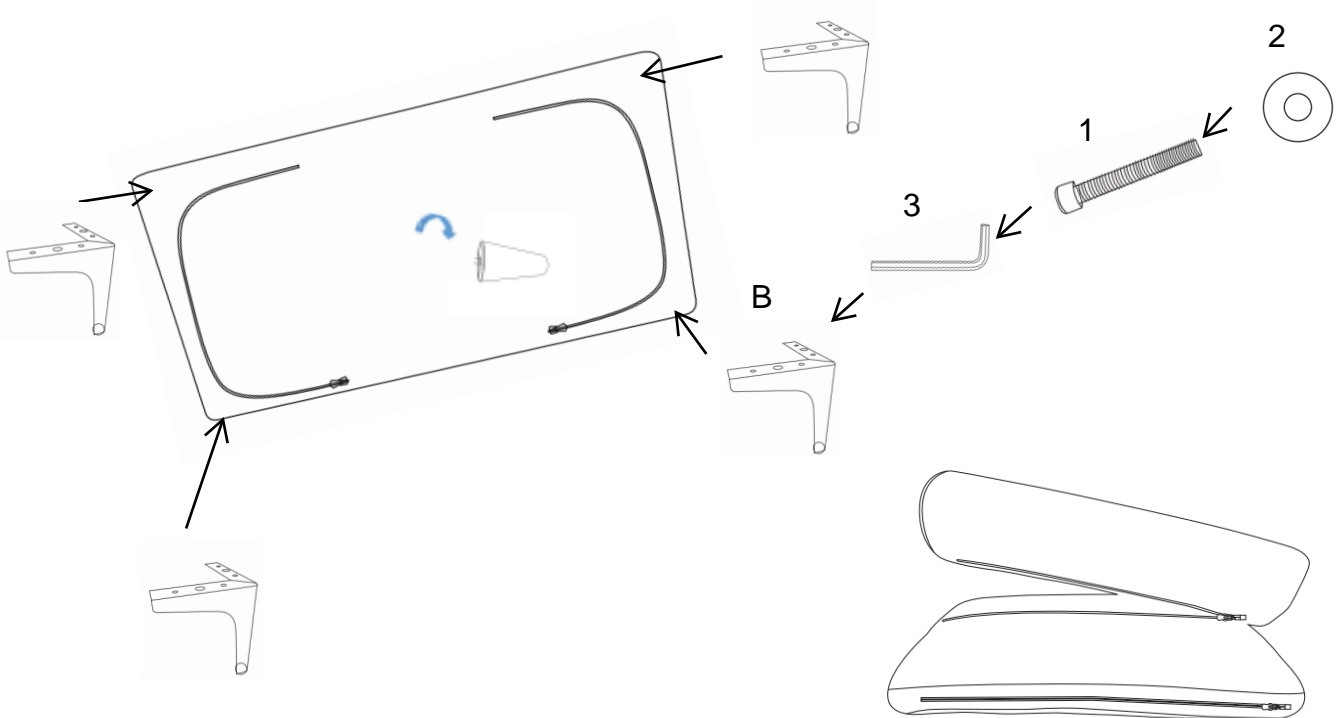

STEP 3

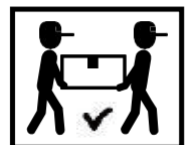
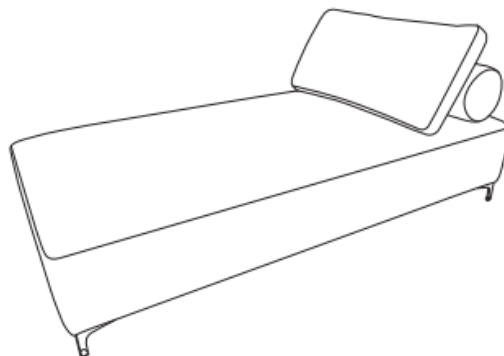

ITEM: **509060**

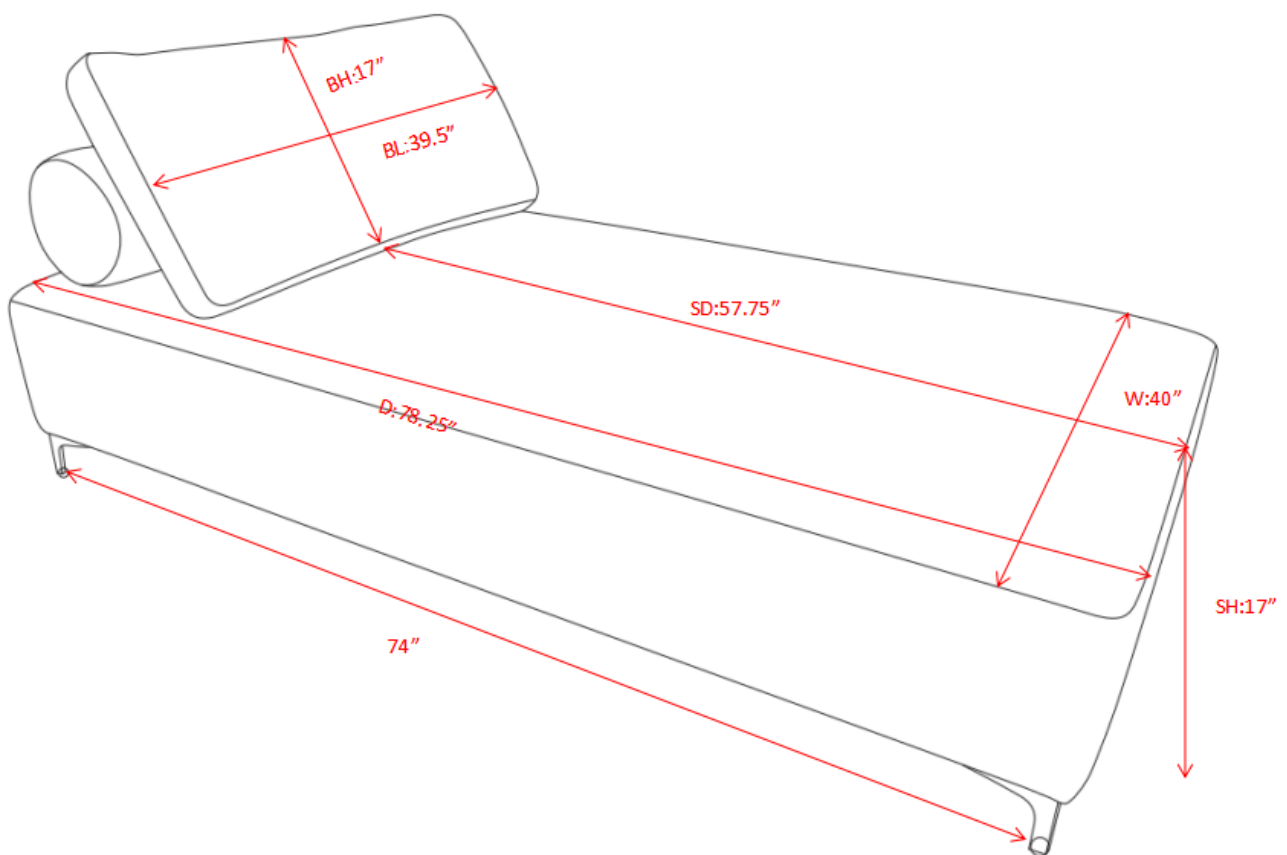

Note : Dimension tolerance $\pm 5\%$