



ASSEMBLY INSTRUCTIONS
COASTER FINE FURNITURE



600380
SECTIONAL

ITEM: 600380B1

ASSEMBLY INSTRUCTIONS



ASSEMBLY TIPS:

- 1.Remove hardware from box and sort by size.
- 2.Please check to see that all hardware and parts are present prior to start of assembly.
- 3.Please follow attached instructions in the same sequence as numbered to assure fast & easy assembly.



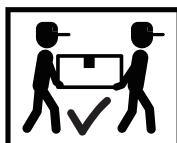

⚠ WARNING !

- 1.Don't attempt to repair or modify parts that are broken or defective. Please contact the store immediately.
- 2.This product is for home use only and not intended for commercial establishment.

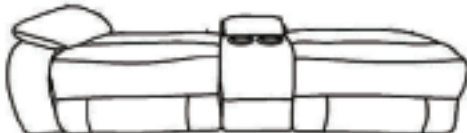

ASSEMBLY TIME PER UNIT: 15MINUTES

PARTS IDENTIFICATION

A		LOVESEAT BASE <u>1PC</u>
B		LOVESEAT LEFT BACK <u>1PC</u>
C		LOVESEAT RIGHT BACK <u>1PC</u>
D		LEFT POWER CABLE <u>1PC</u>
E		CONSOLE BACK <u>1PC</u>

ITEM: 600380B1

ASSEMBLY INSTRUCTIONS



STEP 1

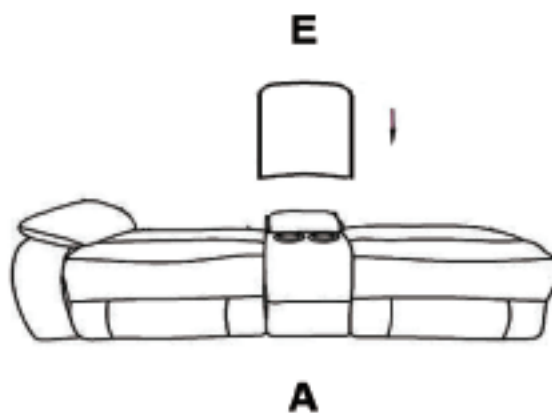

STEP 2

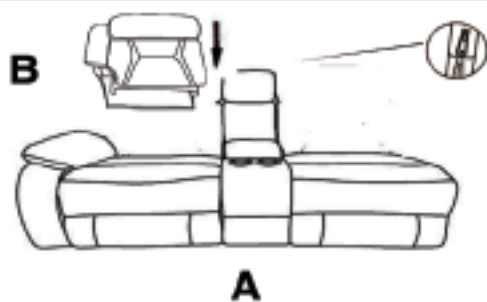

STEP 3

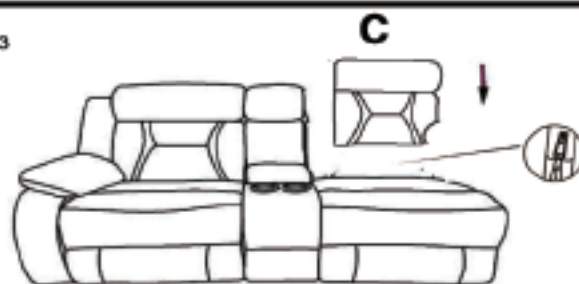

STEP 4

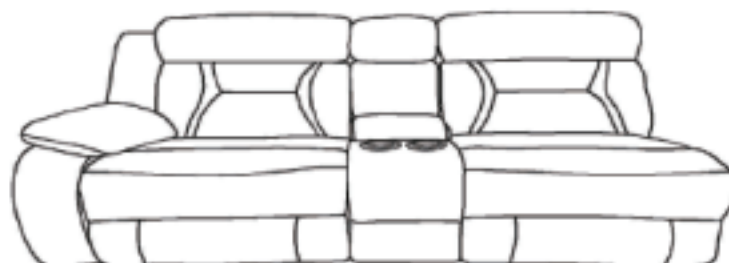
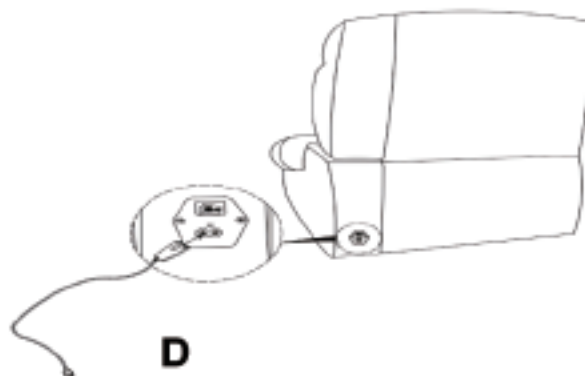

ITEM: 600380B1

ASSEMBLY INSTRUCTIONS



STEP 1

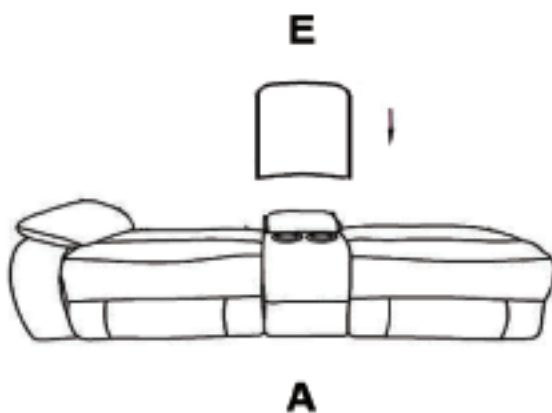

STEP 2

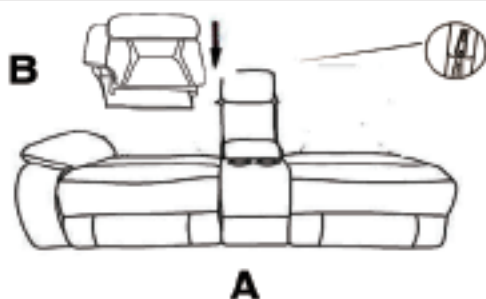

STEP 3

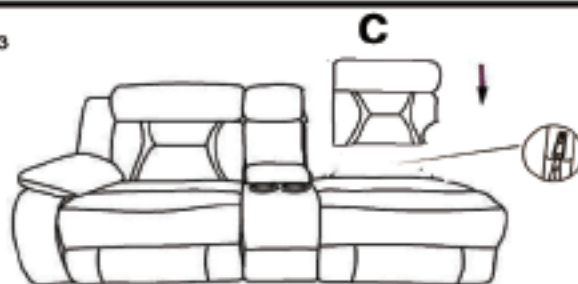

STEP 4

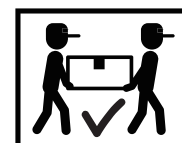
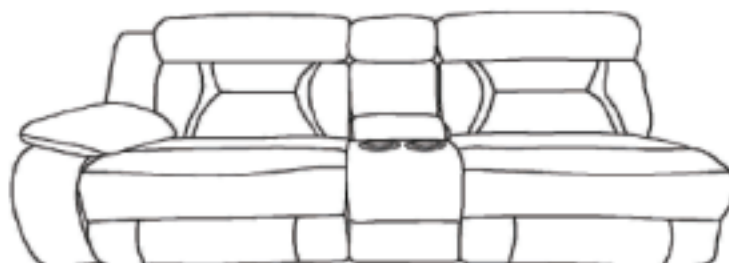
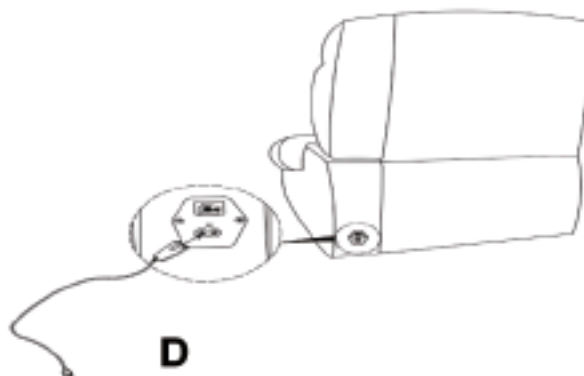

ITEM: 600380B2

ASSEMBLY INSTRUCTIONS



STEP 1

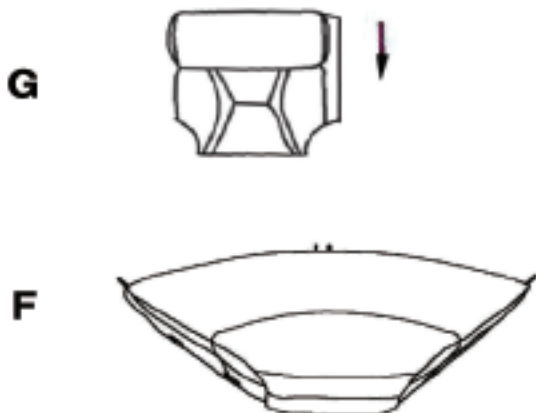

STEP 2

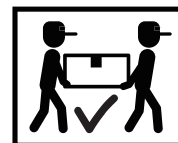
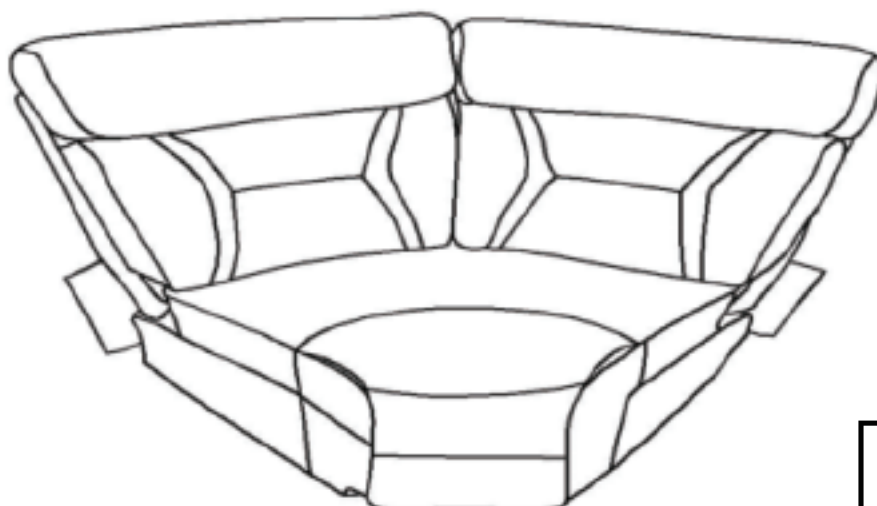

ITEM: 600380B3

ASSEMBLY INSTRUCTIONS



PARTS IDENTIFICATION

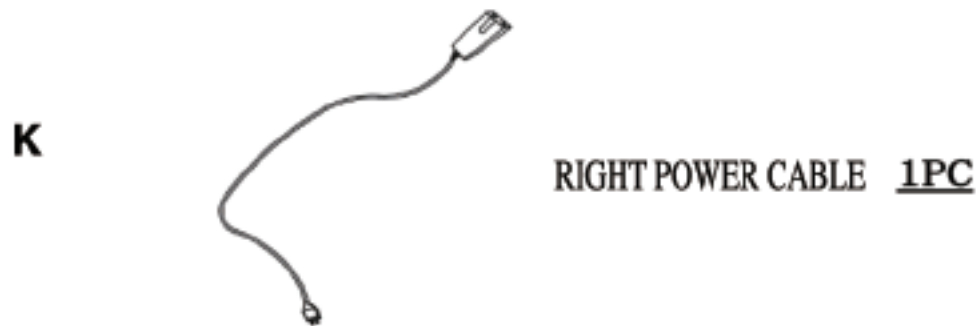

ITEM: 600380B3

ASSEMBLY INSTRUCTIONS



STEP 1

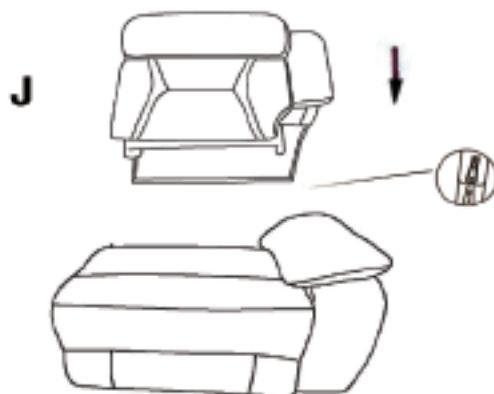

STEP 2

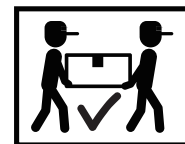
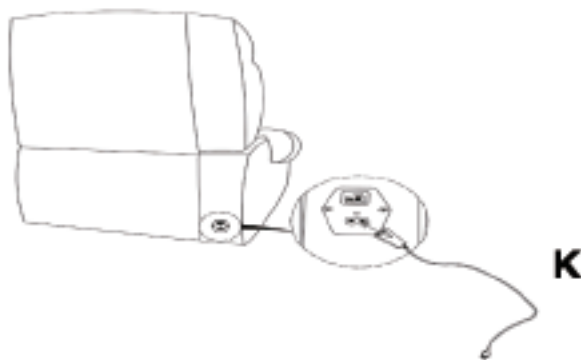

ITEM: 600380AC

ASSEMBLY INSTRUCTIONS



PARTS IDENTIFICATION

L

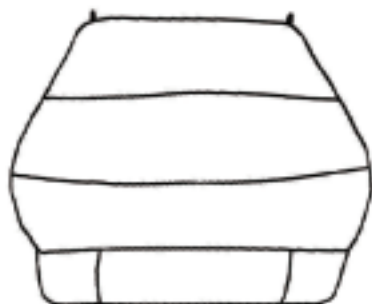

CHAIR BASE 1PC

M



CHAIR BACK 1PC

ITEM: 600380AC

ASSEMBLY INSTRUCTIONS



STEP 1

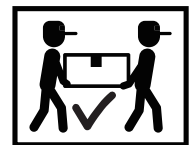
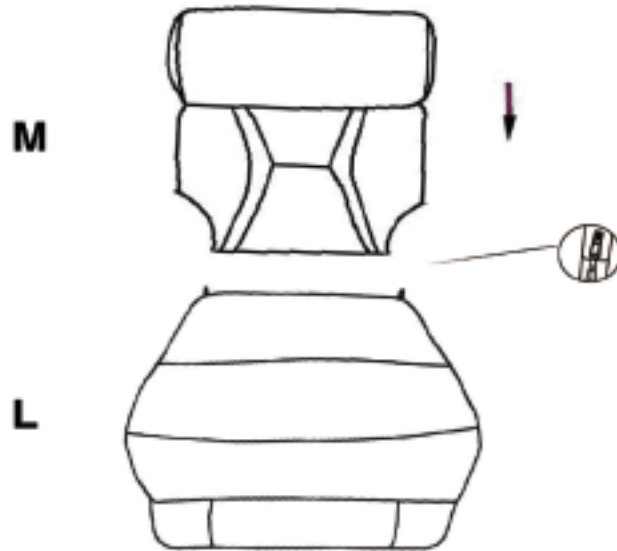

ITEM: 600380

ASSEMBLY INSTRUCTIONS



PARTS IDENTIFICATION

600380B1

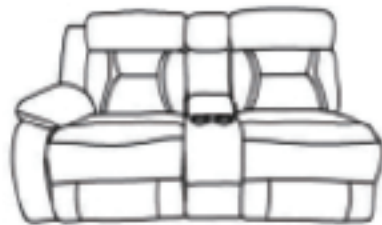

LAF POWER LOVESEAT 1PC

600380B2

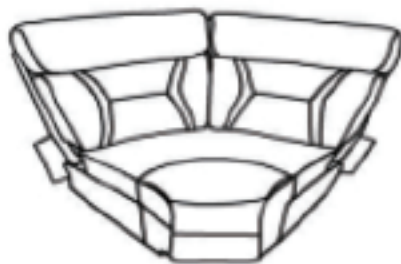

WEDGE 1PC

600380AC



ARMLESS CHAIR 1PC

600380B3



RAF POWER RECLINER CHAIR 1PC

STEP 1

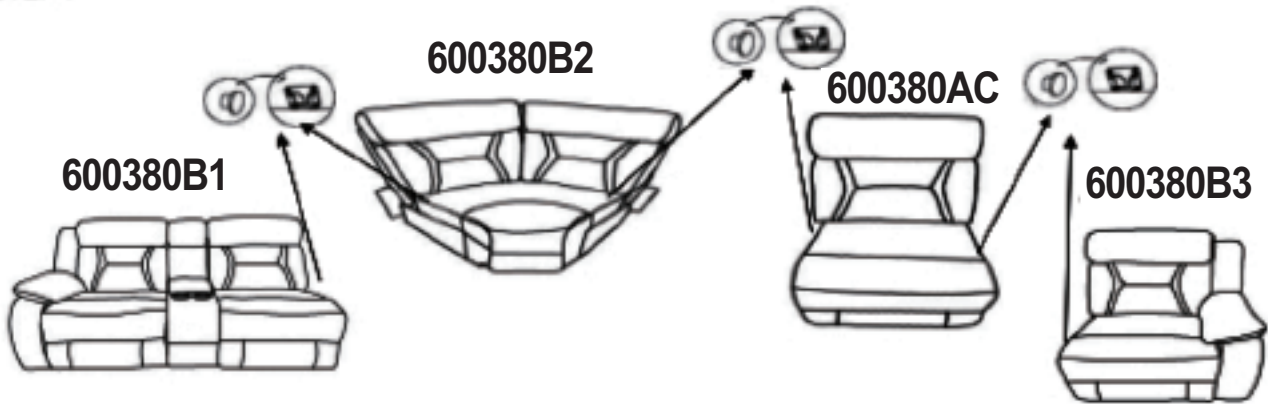

STEP 2

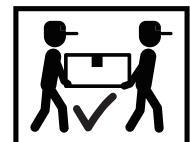
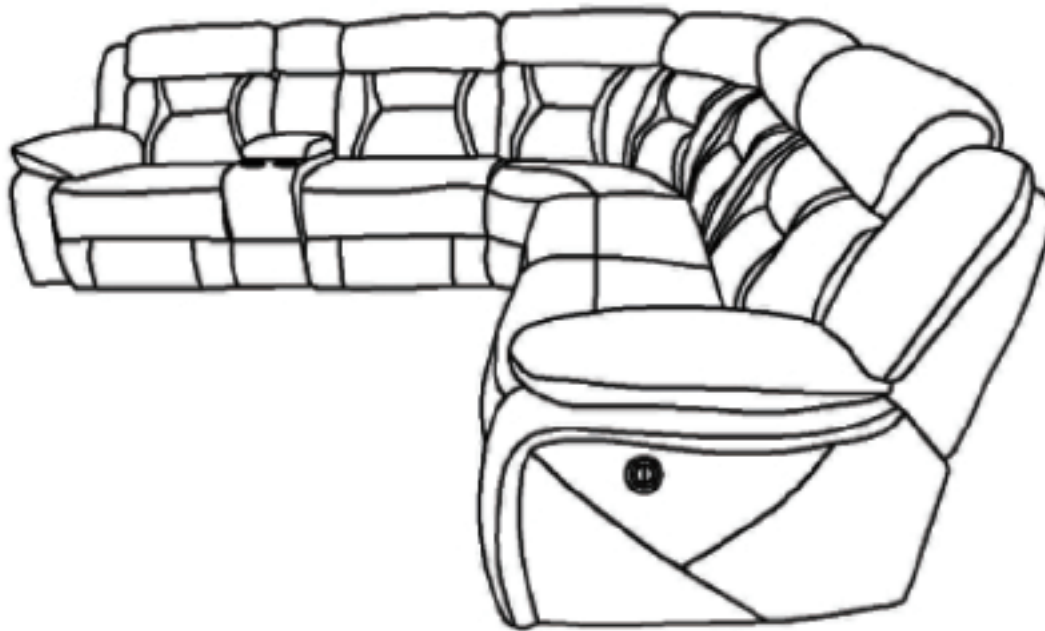

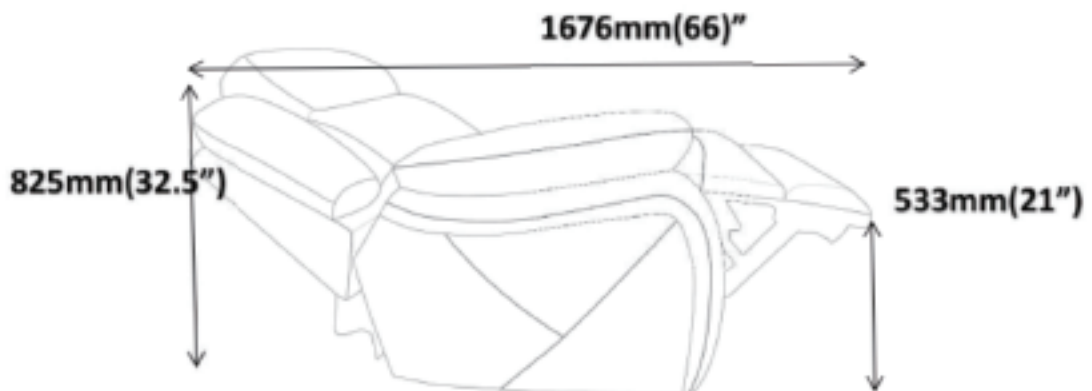
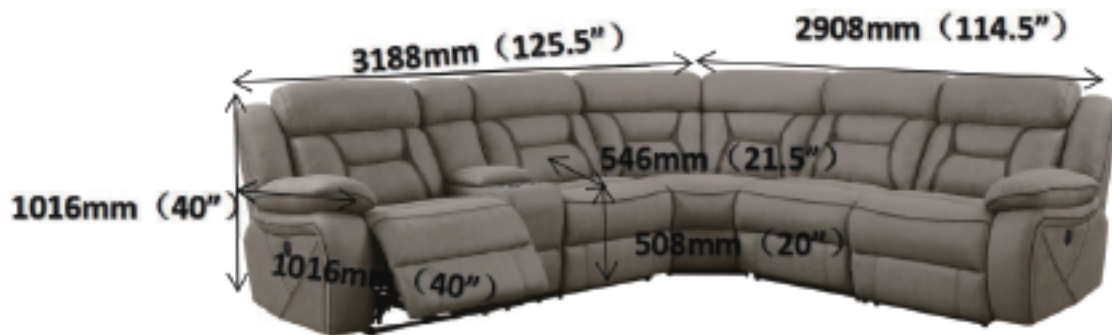
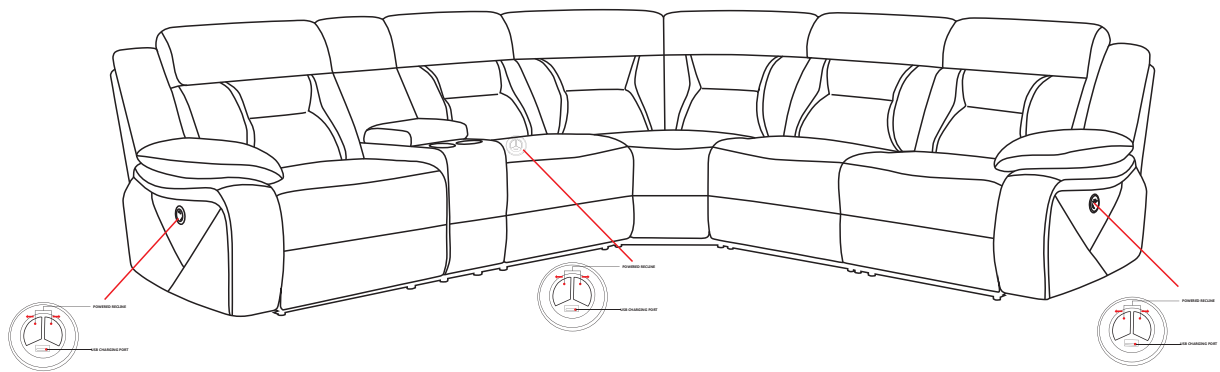

Note : Dimension tolerance $\pm 5\%$

