

*ASSEMBLY INSTRUCTIONS*  
*COASTER FINE FURNITURE*

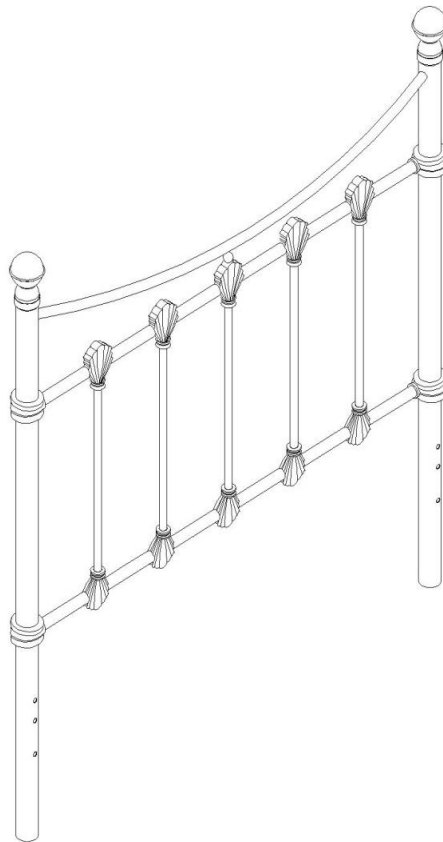

*Fine Furniture for every stage of life*

**450101T**  
***Twin Headboard***

ITEM: **450101T**



## ASSEMBLY INSTRUCTIONS

### ASSEMBLY TIPS:

1. Remove hardware from box and sort by size.
2. Please check to see that all hardware and parts are present prior to start of assembly.
3. Please follow attached instructions in the same sequence as numbered to assure fast & easy assembly.

### WARNING!

1. Don't attempt to repair or modify parts that are broken or defective. Please contact the store immediately.
2. This product is for home use only and not intended for commercial establishments.









ASSEMBLY TIME

10 MINUTES

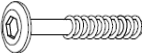
## PARTS IDENTIFICATION

A	HEADBOARD		1PC	B	FINIAL		2PCS
---	-----------	---	-----	---	--------	---	------

## HARDWARE IDENTIFICATION

1	BOLT 1/4X62mm		4PCS	4	NUT 1/4 mm		4PCS
2	WASHER 18mm		4PCS	5	ALLEN KEY 4mm		1PC
3	PVC WASHER 23X4mm		4PCS	6	WRENCH 10mm		1PC

## ASSEMBLY INSTRUCTIONS

1

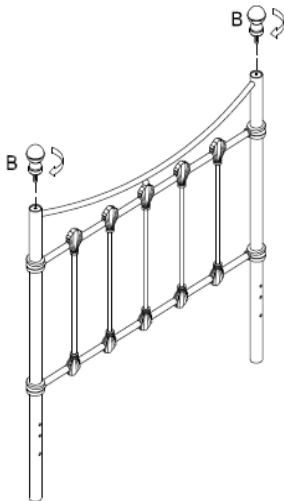

2

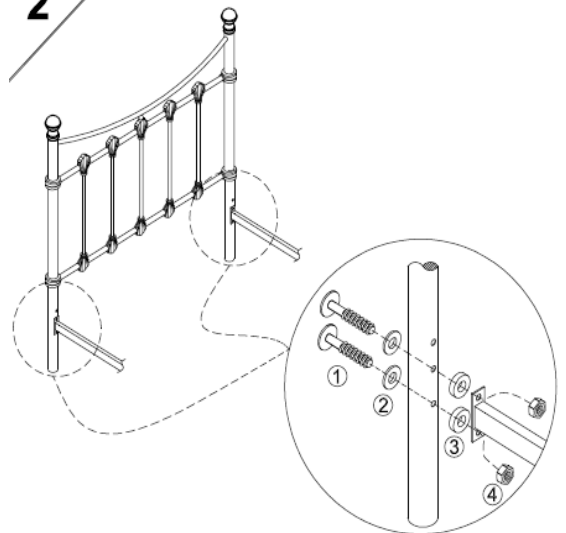

### NOTE:

Phillips head screw driver is required in the assembly process; however, manufacturer does not provide this item.

ITEM: **450101T**



**PRODUCT DIMENSION**

