

ASSEMBLY INSTRUCTIONS COASTER FINE FURNITURE

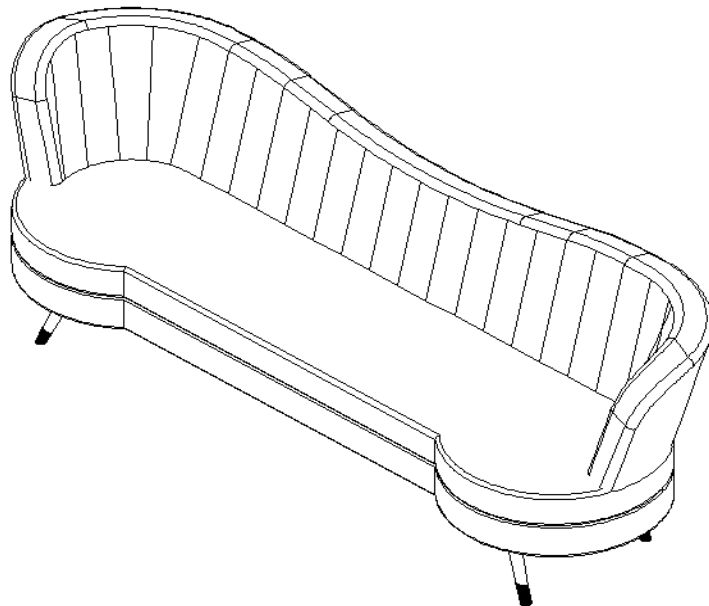

Fine Furniture for every stage of life

506864
sofa

ITEM:506864



ASSEMBLY INSTRUCTIONS

ASSEMBLY TIPS:

1. Remove hardware from box and sort by size.
2. Please check to see that all hardware and parts are present prior to start of assembly.
3. Please follow attached instructions in the same sequence as numbered to assure fast & easy assembly.



WARNING!

1. Don't attempt to repair or modify parts that are broken or defective. Please contact the store immediately.
2. This product is for home use only and not intended for commercial establishments.

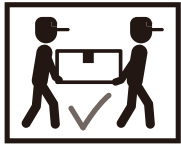

ASSEMBLY TIME

30 MINUTES

PARTS IDENTIFICATION

A Sofa

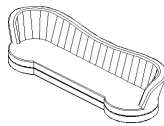

1PC

B

Leg



5PCS

HARDWARE IDENTIFICATION

1

BOLT
(M6X25MM)



20PCS

2

ALLEN WRENCH
(4#)



1PCS

STEP 1

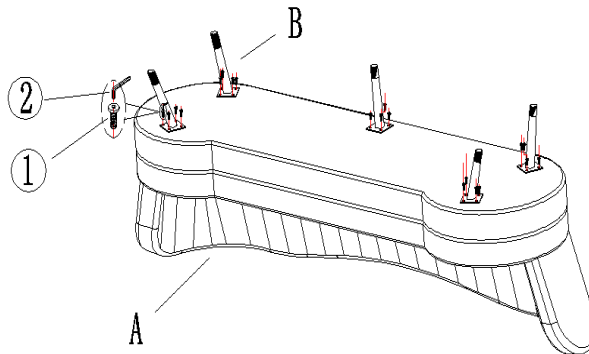

STEP 2

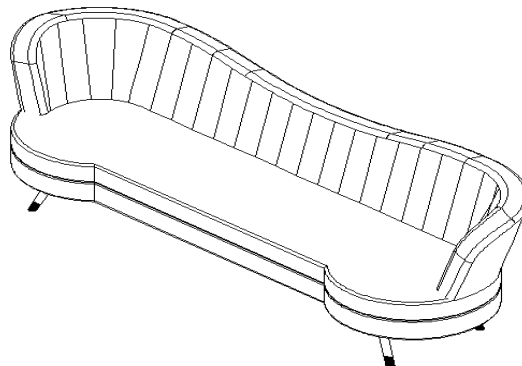

ITEM:506864



ASSEMBLY INSTRUCTIONS

PRODUCT DIMENSION

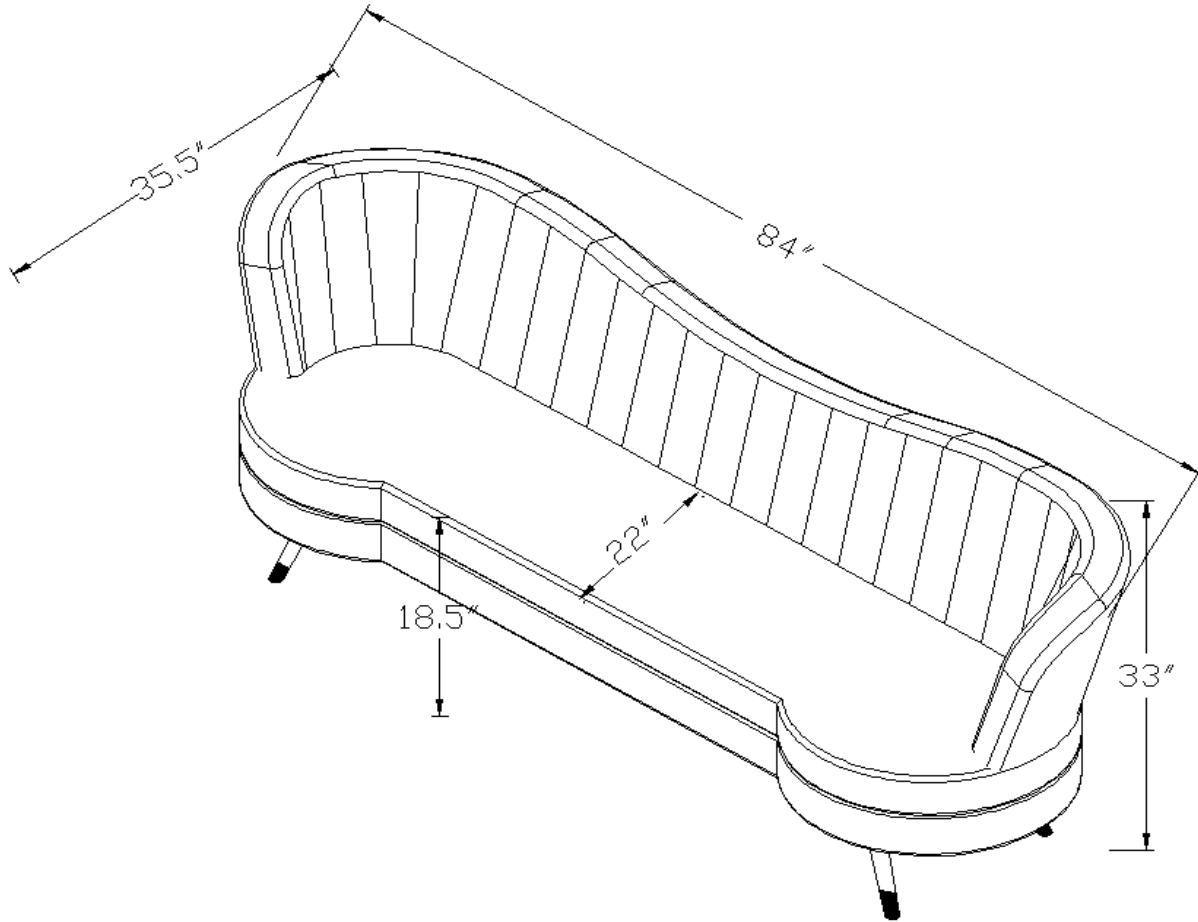

Note: Dimension tolerance $\pm 5\%$