

*ASSEMBLY INSTRUCTIONS  
COASTER FINE FURNITURE*

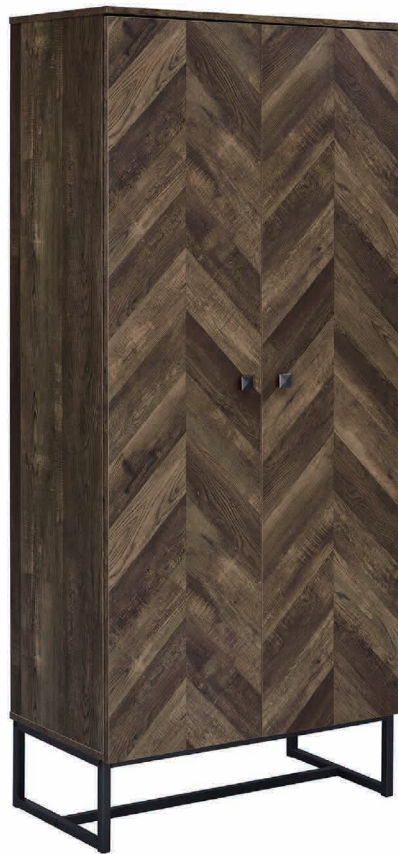

*Fine Furniture for every stage of life*

**959640**  
**ACCENT CABINET**

ITEM:959640

## ASSEMBLY INSTRUCTIONS

### ASSEMBLY TIPS:

1. Remove hardware from box and sort by size.
2. Please check to see that all hardware and parts are present prior to start of assembly.
3. Please follow attached instructions in the same sequence as numbered to assure fast & easy assembly.



### WARNING!

1. Don't attempt to repair or modify parts that are broken or defective. Please contact the store immediately.
2. This product is for home use only and not intended for commercial establishments.

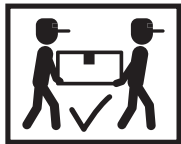

ASSEMBLY TIME

60 MINUTES

## PARTS IDENTIFICATION

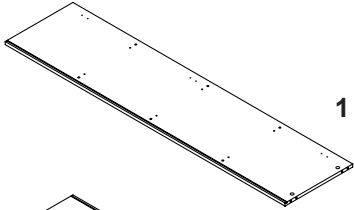
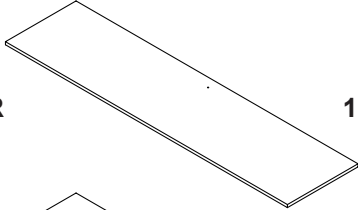
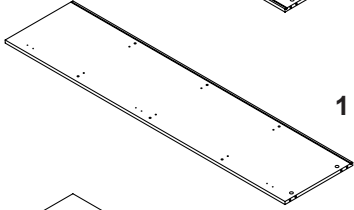
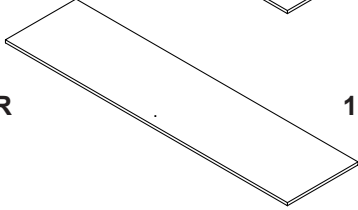
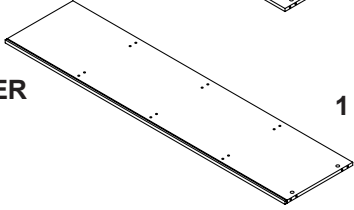
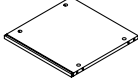
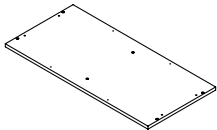
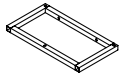
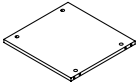
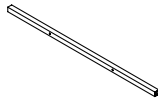
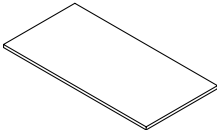
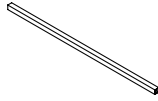
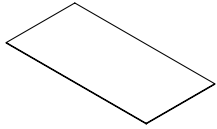









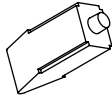

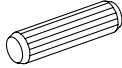
A	LEFT SIDE PANEL		1 PC	H	LEFT DOOR		1 PC
B	RIGHT SIDE PANEL		1 PC	I	RIGHT DOOR		1 PC
C	MIDDLE DIVIDER PANEL		1 PC	J	MIDDLE CROSS PANEL		2 PCS
D	BOTTOM PANEL		1 PC	K	LEG FRAME		2 PCS
E	CROSS PANEL		4 PCS	L	UPPER CROSSBAR		2 PCS
F	TOP PANEL		1 PC	M	LOWER CROSSBAR		1 PC
G	BACK PANEL		4 PCS				

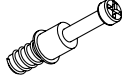
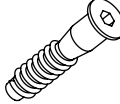
### NOTE:

Phillips head screw driver is required in the assembly process; however, manufacturer does not provide this item.

ITEM: **959640**

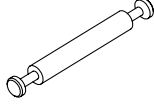
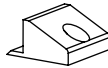
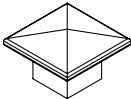
**HARDWARE IDENTIFICATION**

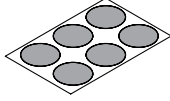
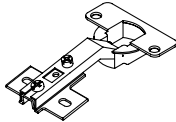
Z							
NO	DESCRIPTION	FIGURE	Q'TY	NO	DESCRIPTION	FIGURE	Q'TY
1	GLUE 40g		1 PC	11	HINGE SCREW Ø4x15mm SR		24 PCS
2	WOODEN DOWEL Ø8x30mm		24 PCS	12	BOLT M6x43mm BLK		6 PCS
3	CAM BOLT Ø7x35.5mm SR		18 PCS	13	BOLT Ø7x32mm BLK		4 PCS
4	CAM LOCK Ø15x12mm SR		30 PCS	14	SCREW Ø5x35mm BLK		4 PCS
5	SCREW Ø4.5x42mm SR		6 PCS	15	FLOOR PROTECTOR 20x20mm		4 PCS
6	WOODEN DOWEL Ø8x50mm		6 PCS	16	ALLEN WRENCH 4mm SR		1 PC
7	CAM BOLT Ø7x63mm SR		6 PCS	17	FIXER		6 PCS
8	HANDLE BLK		2 PCS	18	FIXER SCREW Ø3x19mm SR		6 PCS
9	HANDLE BOLT BLK		2 PCS	19	STICKER Ø20mm		5 PCS
10	HINGE Ø35mm SR		6 PCS				

Z10 not included in blister packaging.

**NOTE:**

Phillips head screw driver is required in the assembly process; however, manufacturer does not provide this item.

ITEM: 959640

**COASTER**<sup>®</sup>

FINE FURNITURE

**STEP 1**

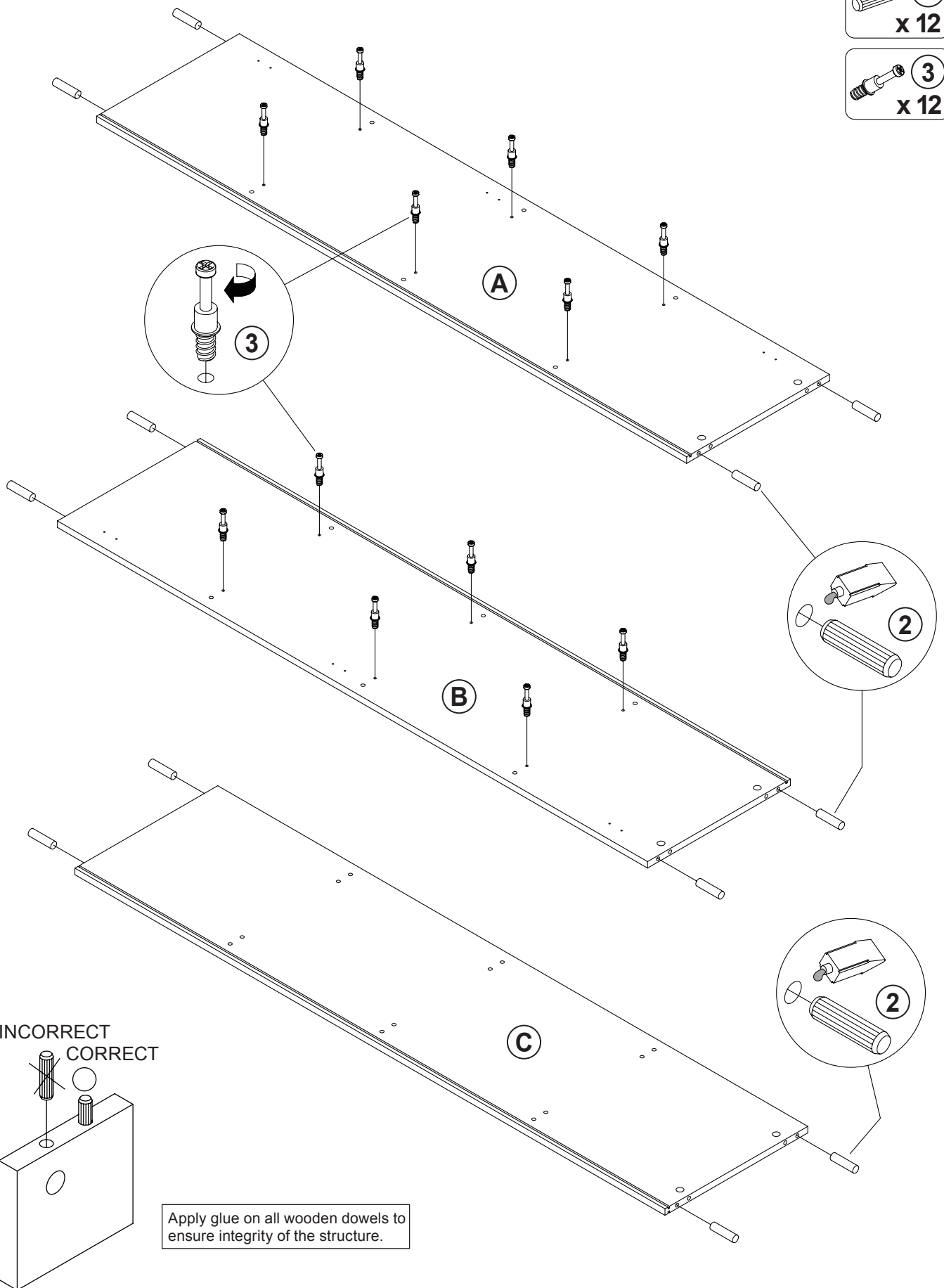
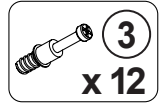
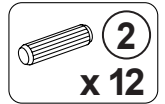

ITEM: 959640

**STEP 2**

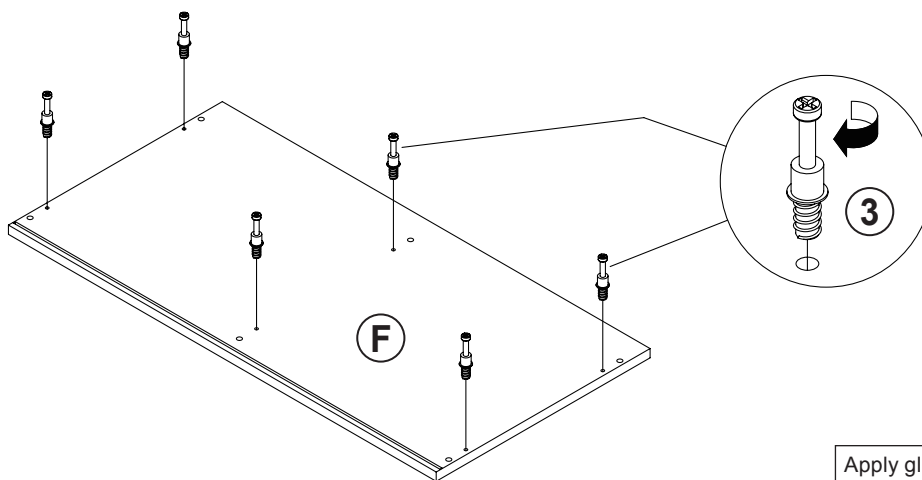
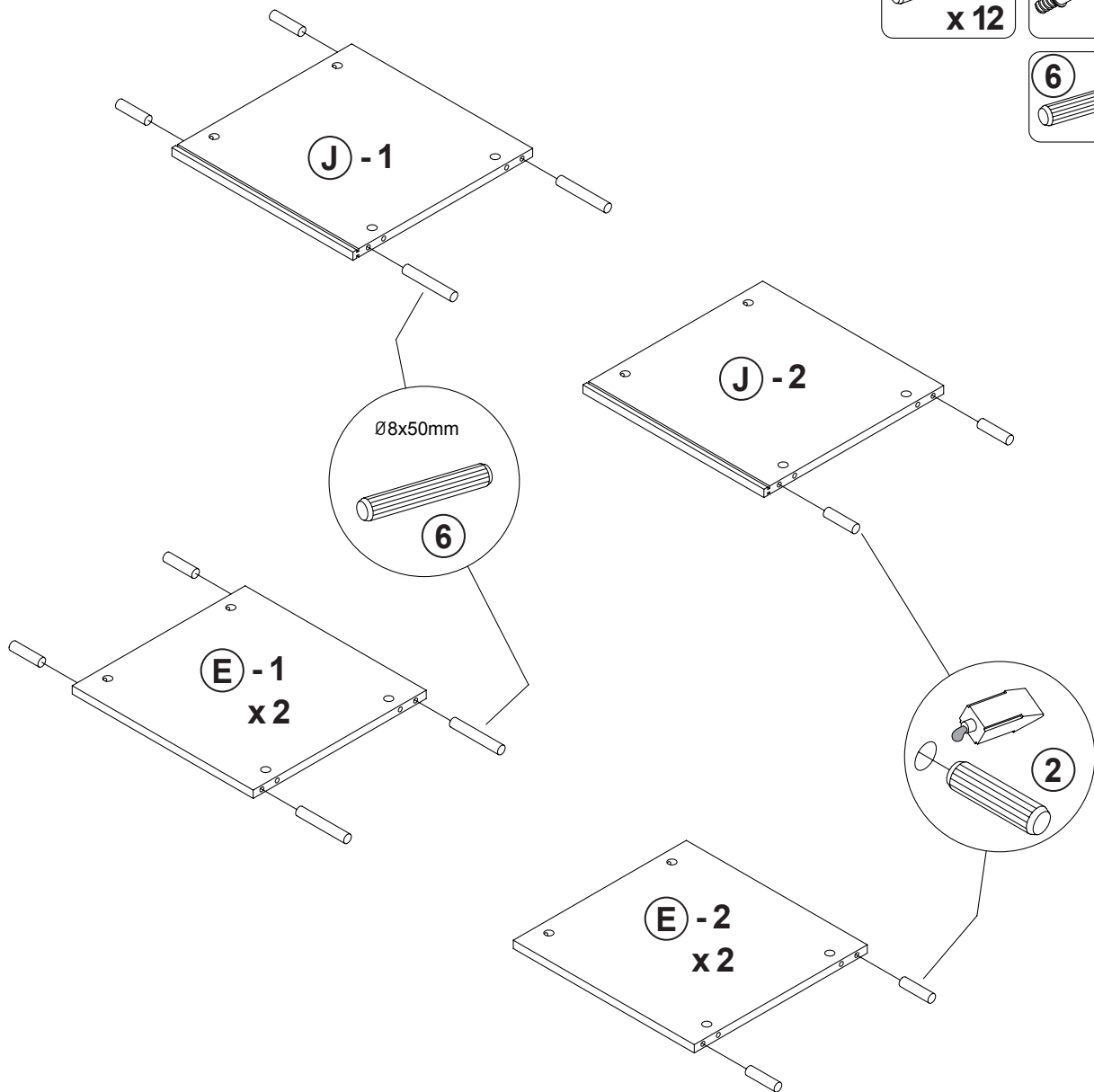
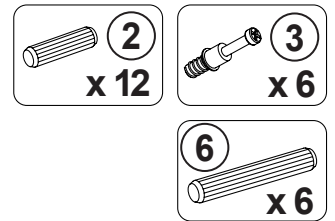

Apply glue on all wooden dowels to ensure integrity of the structure.

ITEM: 959640

**COASTER**  
FINE FURNITURE

**STEP 3**

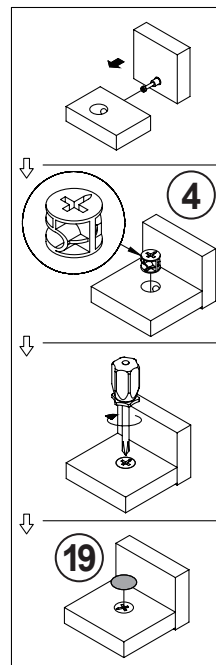
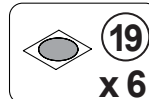
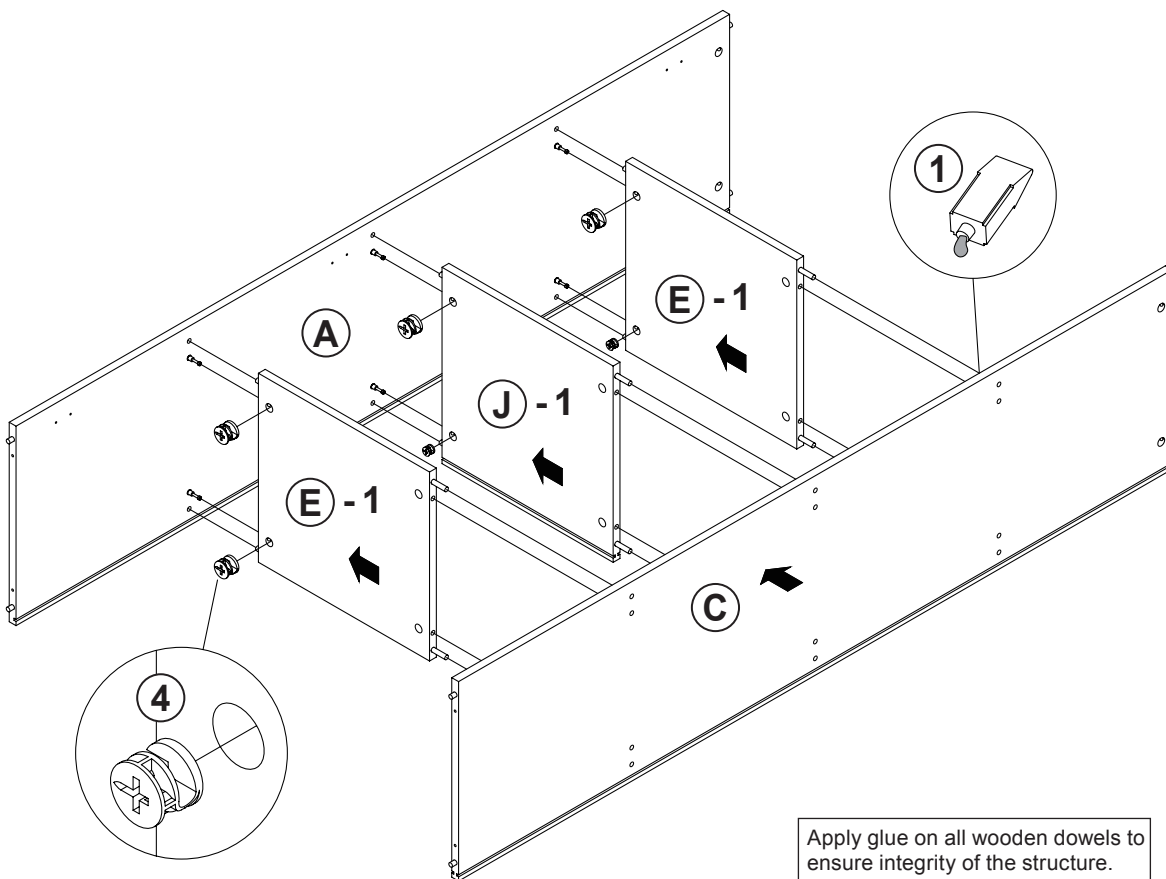

Apply glue on all wooden dowels to ensure integrity of the structure.

**STEP 4**

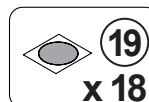
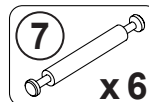
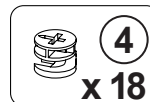
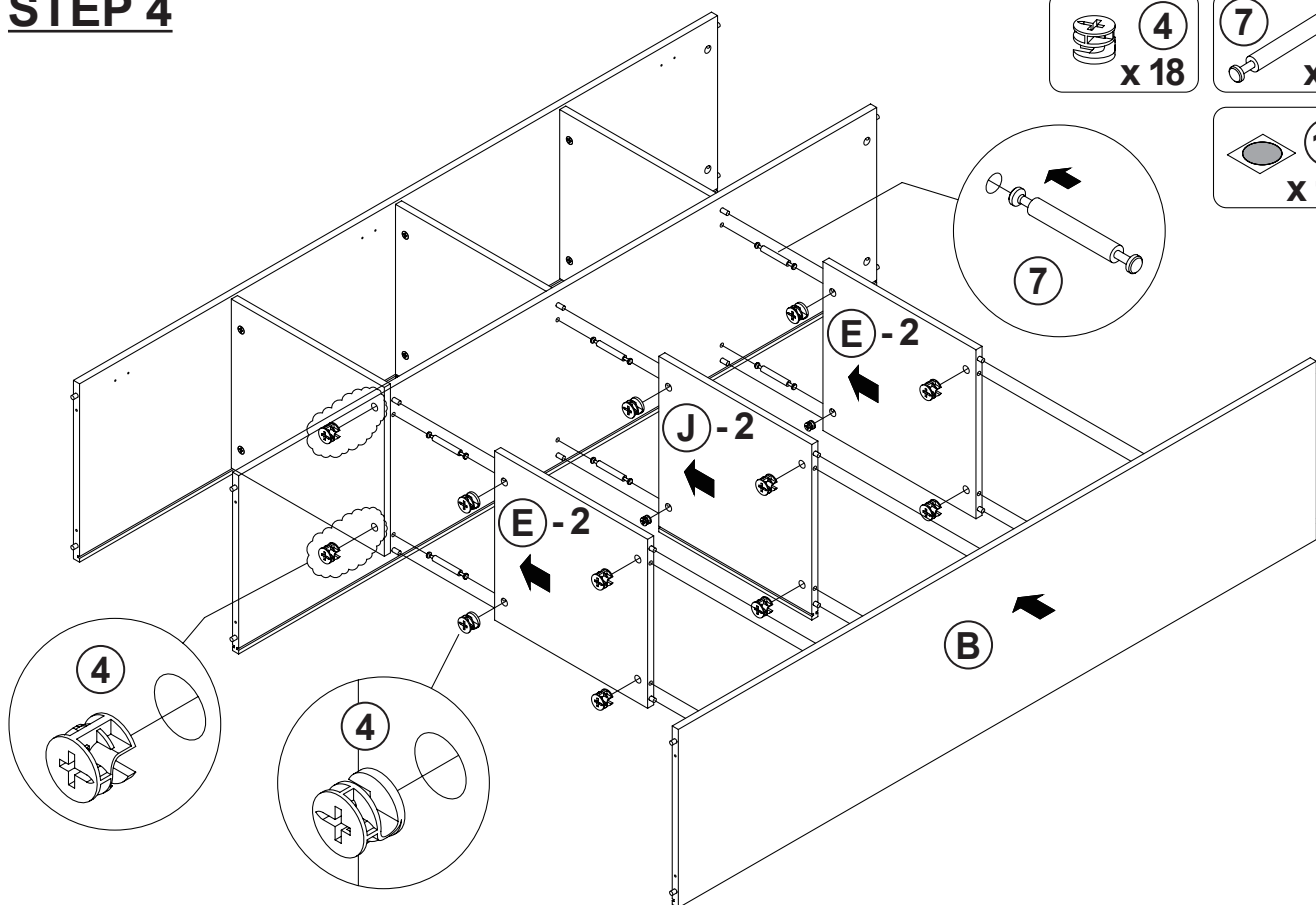

ITEM: 959640

**STEP 5**

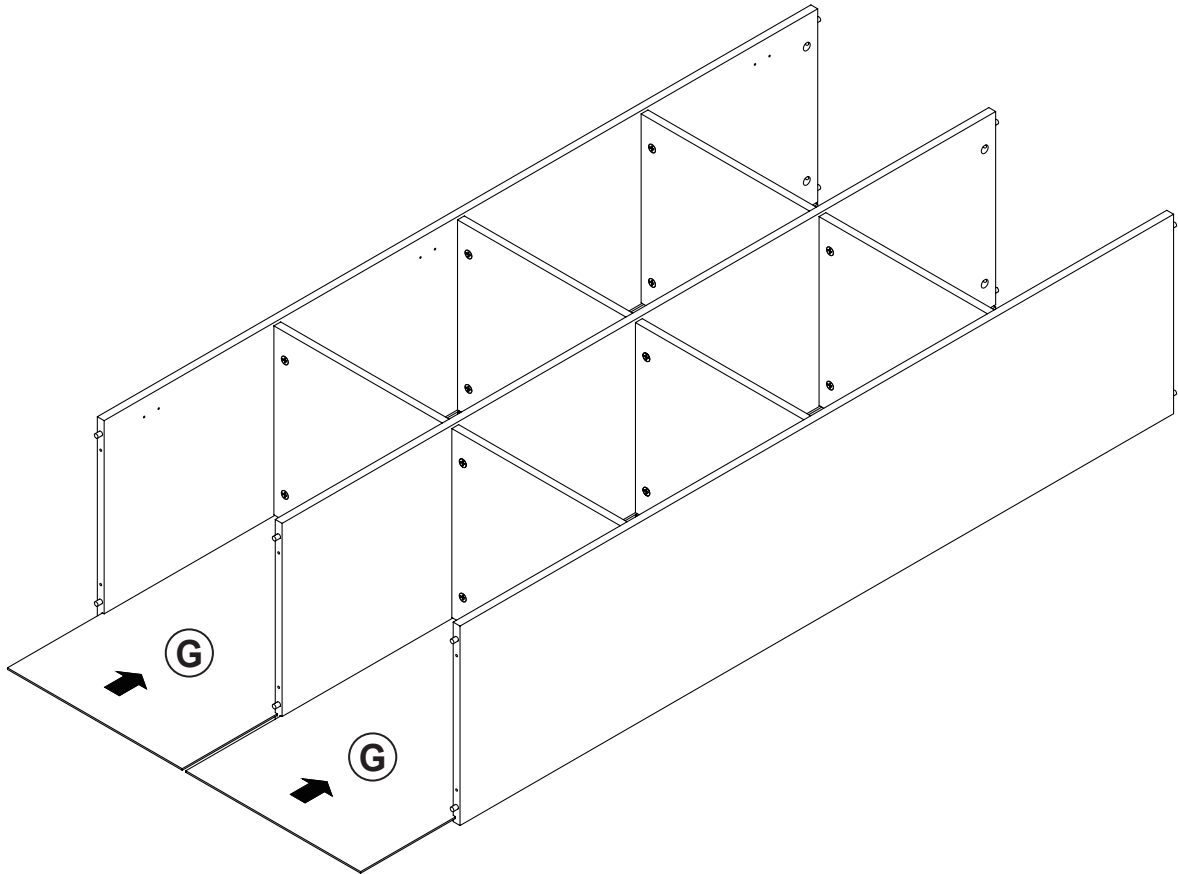

**STEP 6**

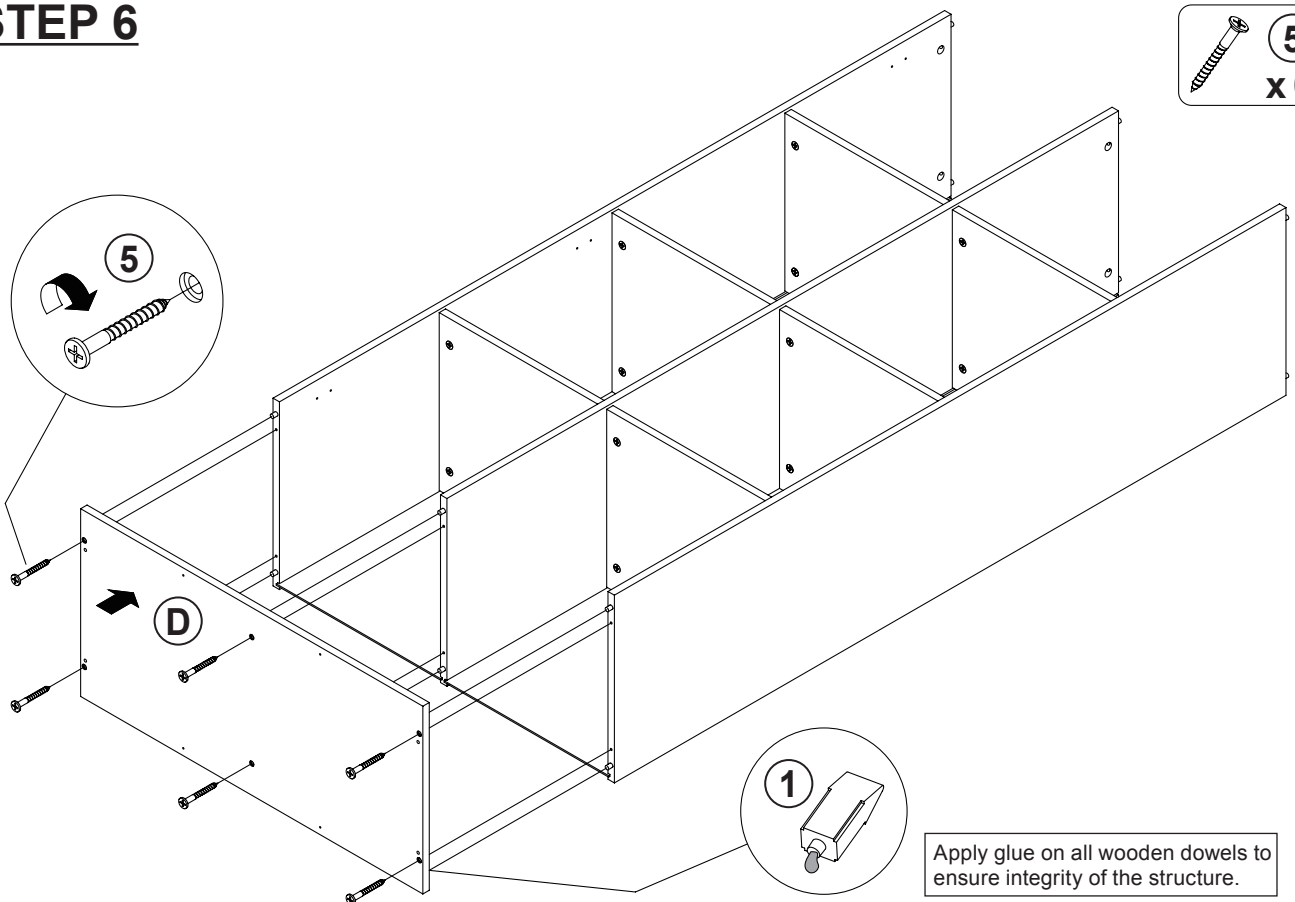
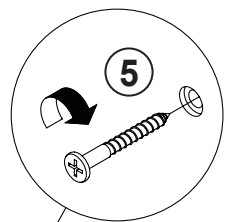
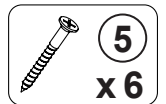

Apply glue on all wooden dowels to ensure integrity of the structure.

ITEM: 959640

**COASTER**  
FINE FURNITURE

**STEP 7**

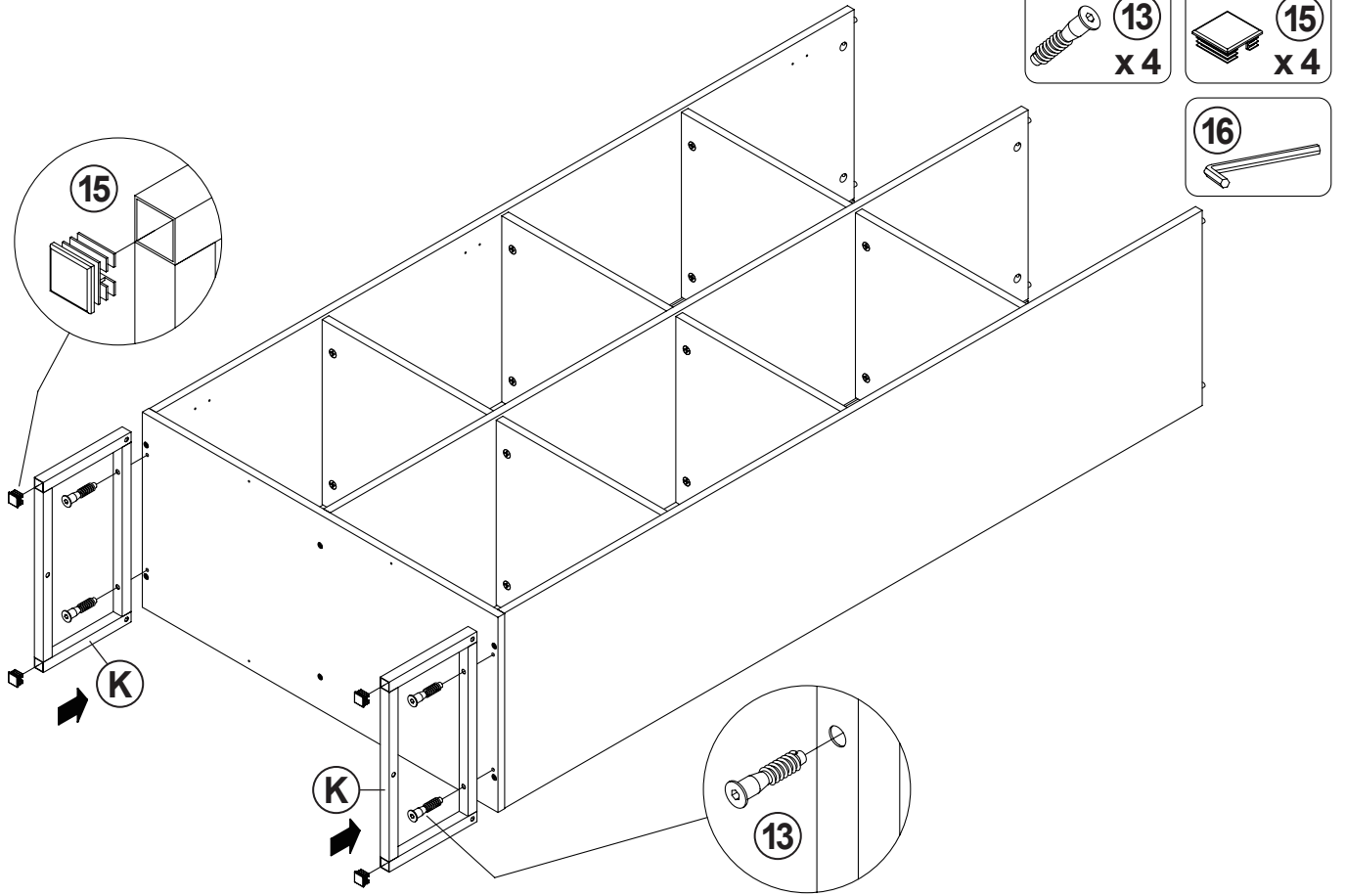

**STEP 8**

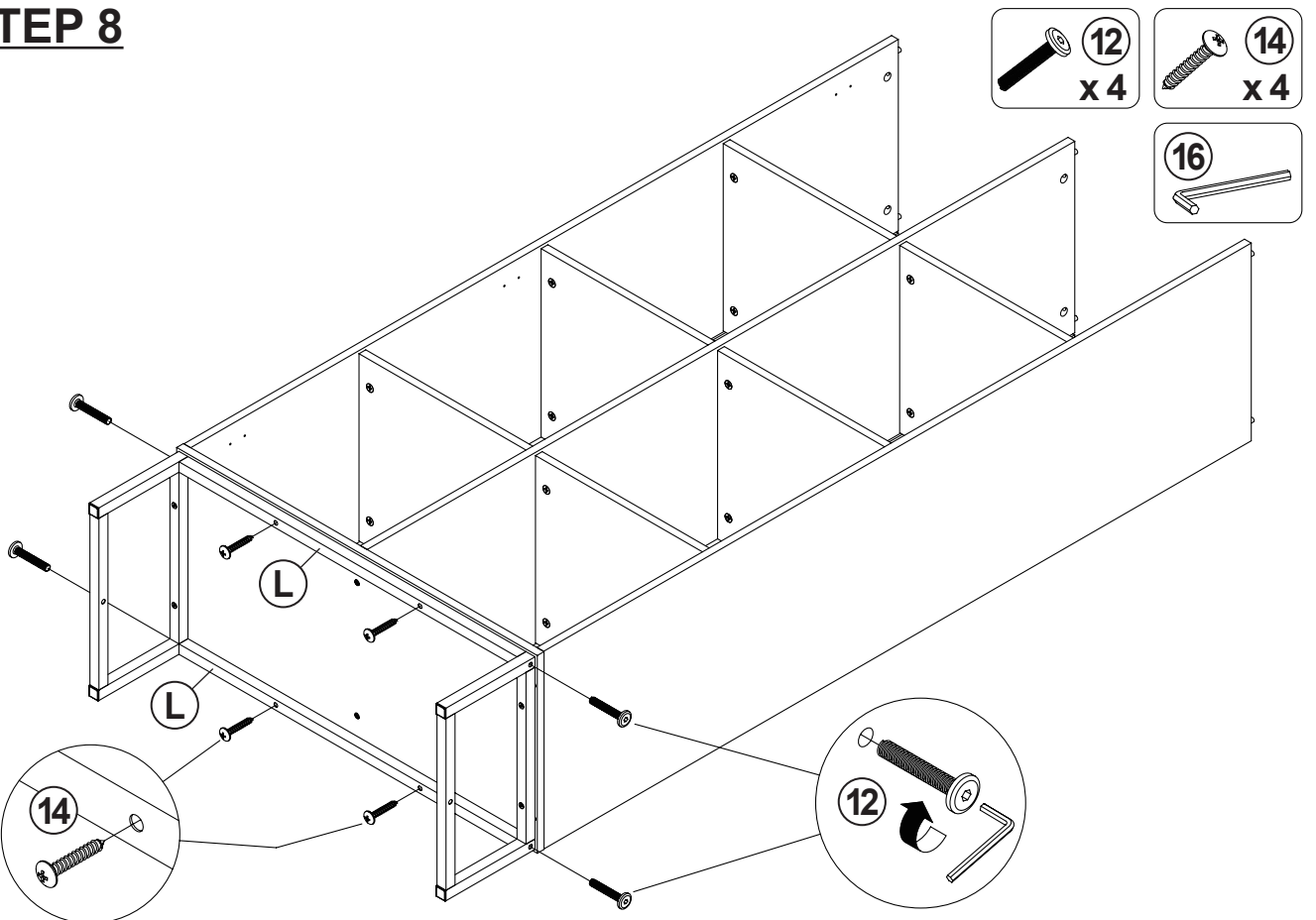



ITEM: 959640

**STEP 9**

**COASTER**  
FINE FURNITURE

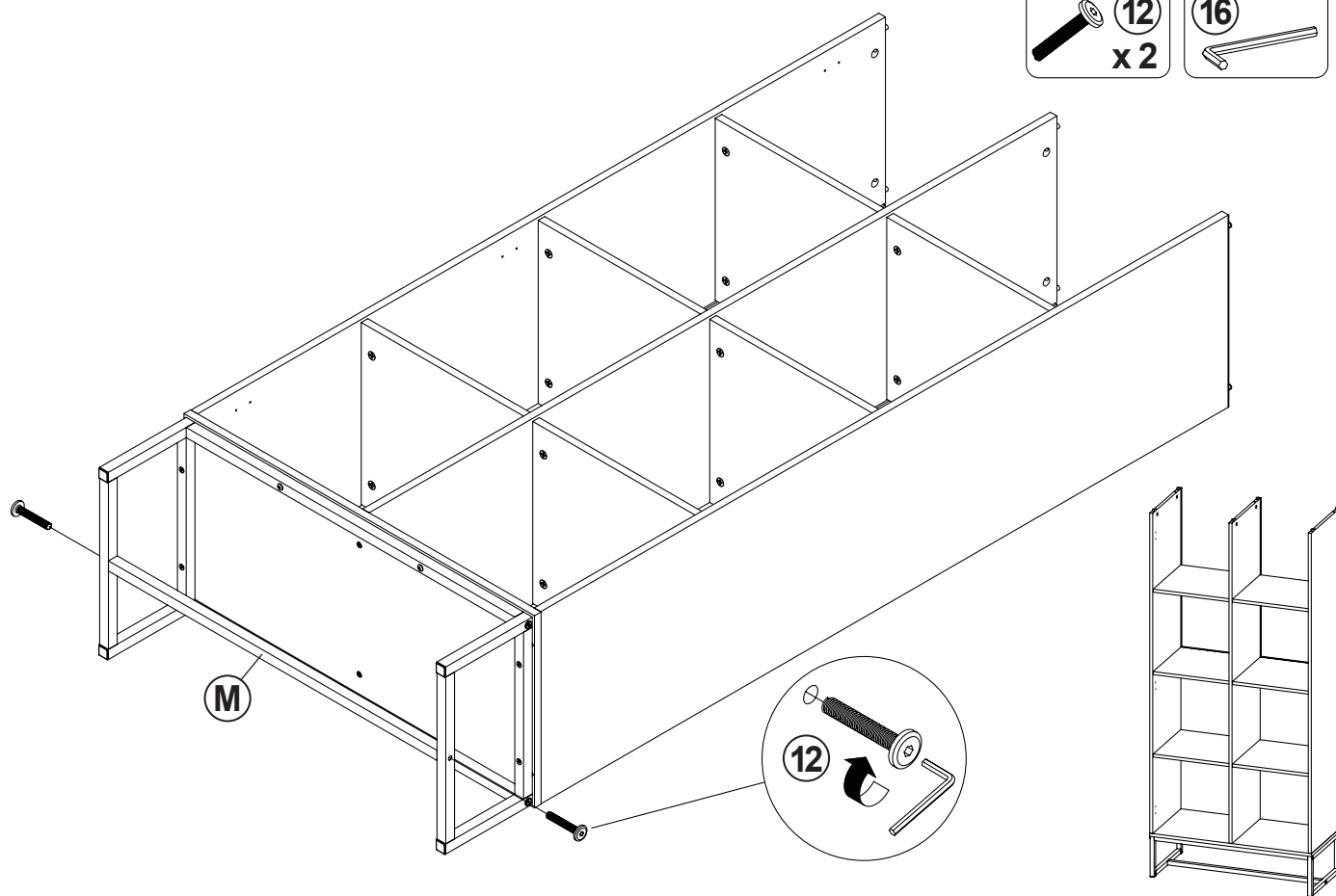

**STEP 10**

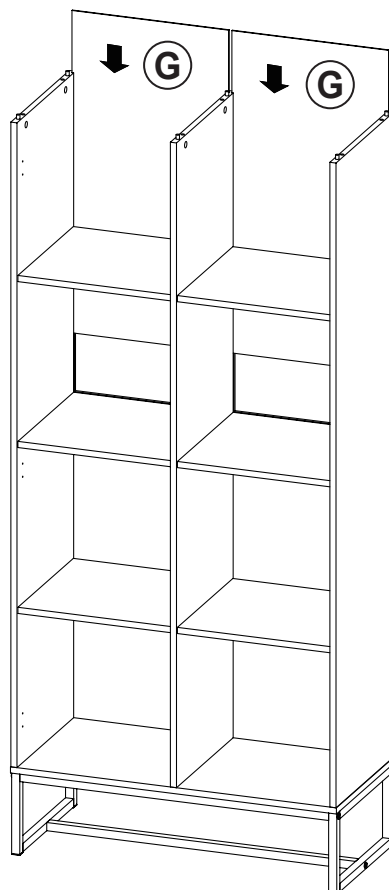

ITEM: **959640**

**COASTER**  
FINE FURNITURE

**STEP 11**

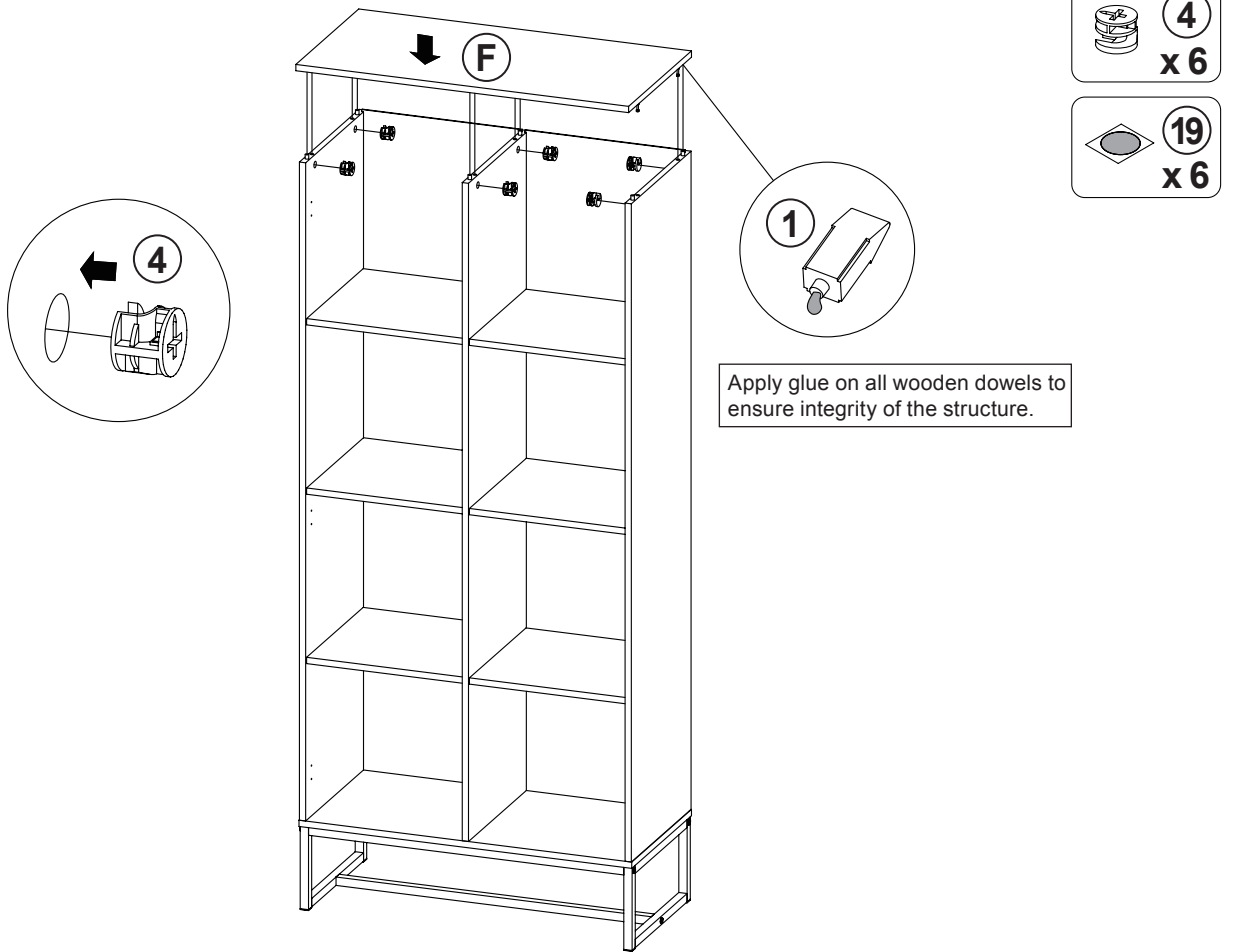

**STEP 12**

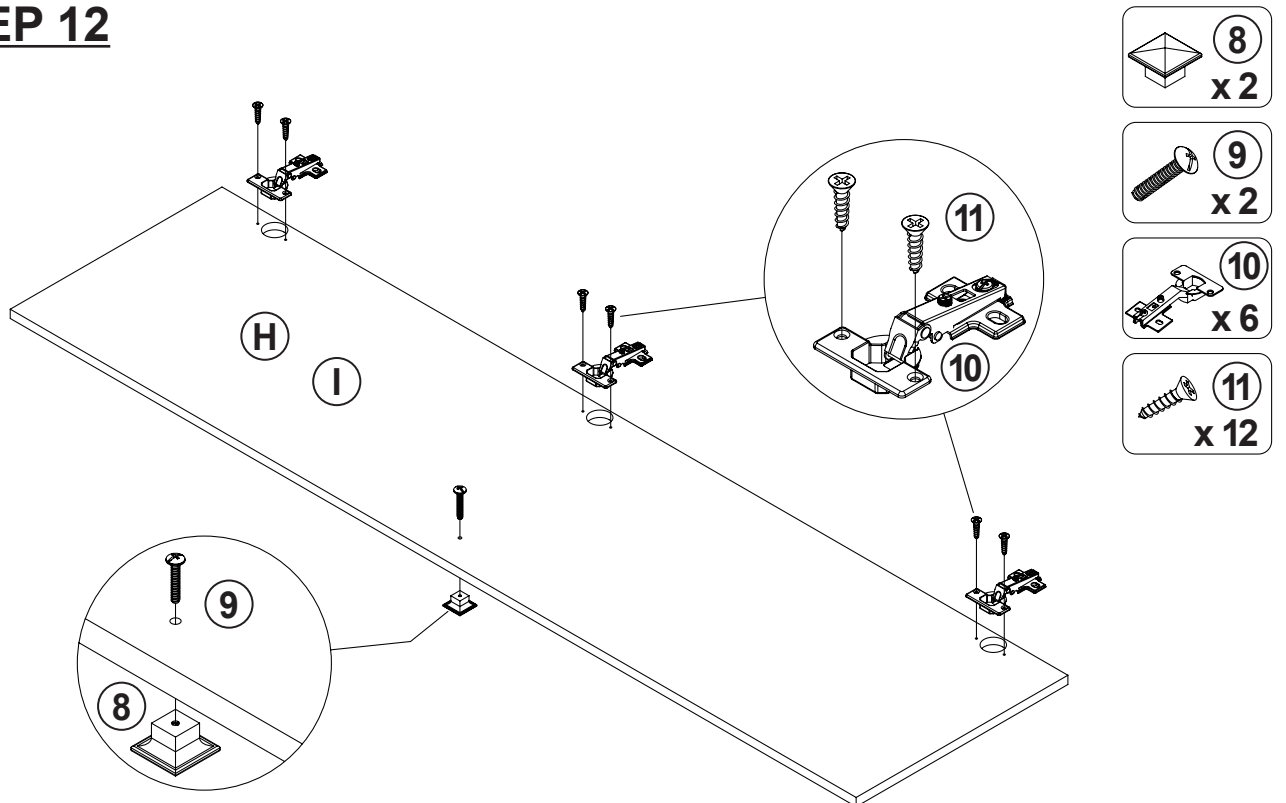

ITEM: 959640

**COASTER**  
FINE FURNITURE

**STEP 13**

11  
x 12

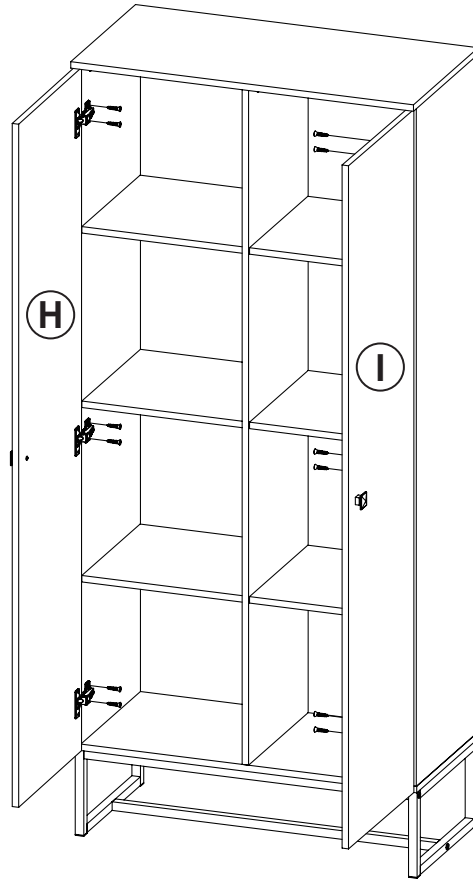
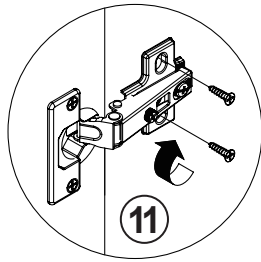
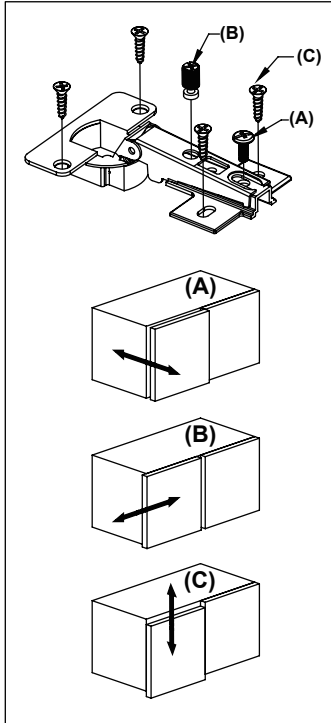

**STEP 14**

17  
x 6

18  
x 6

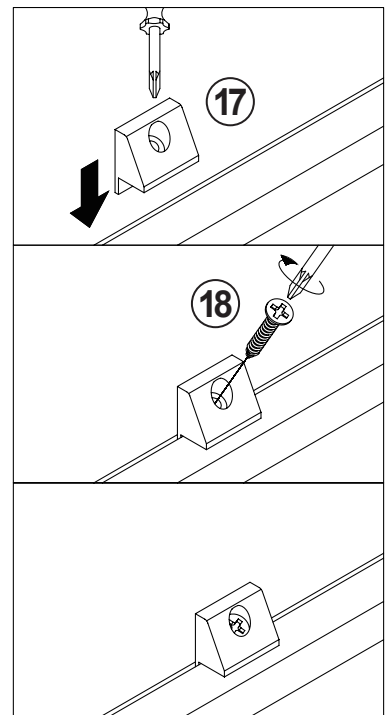
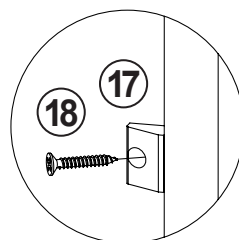
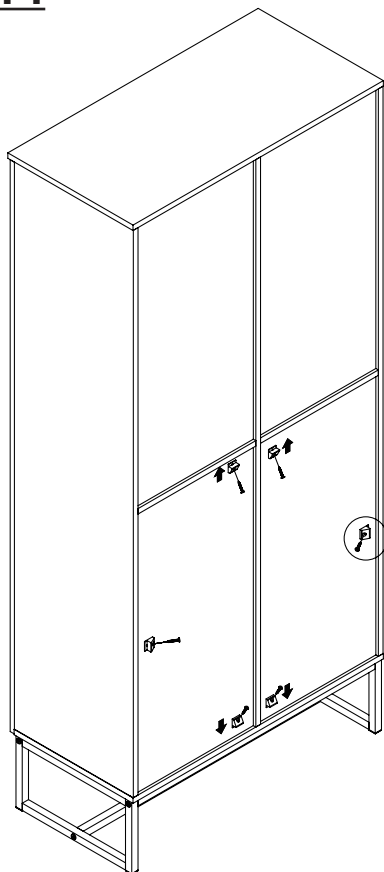

ITEM: 959640

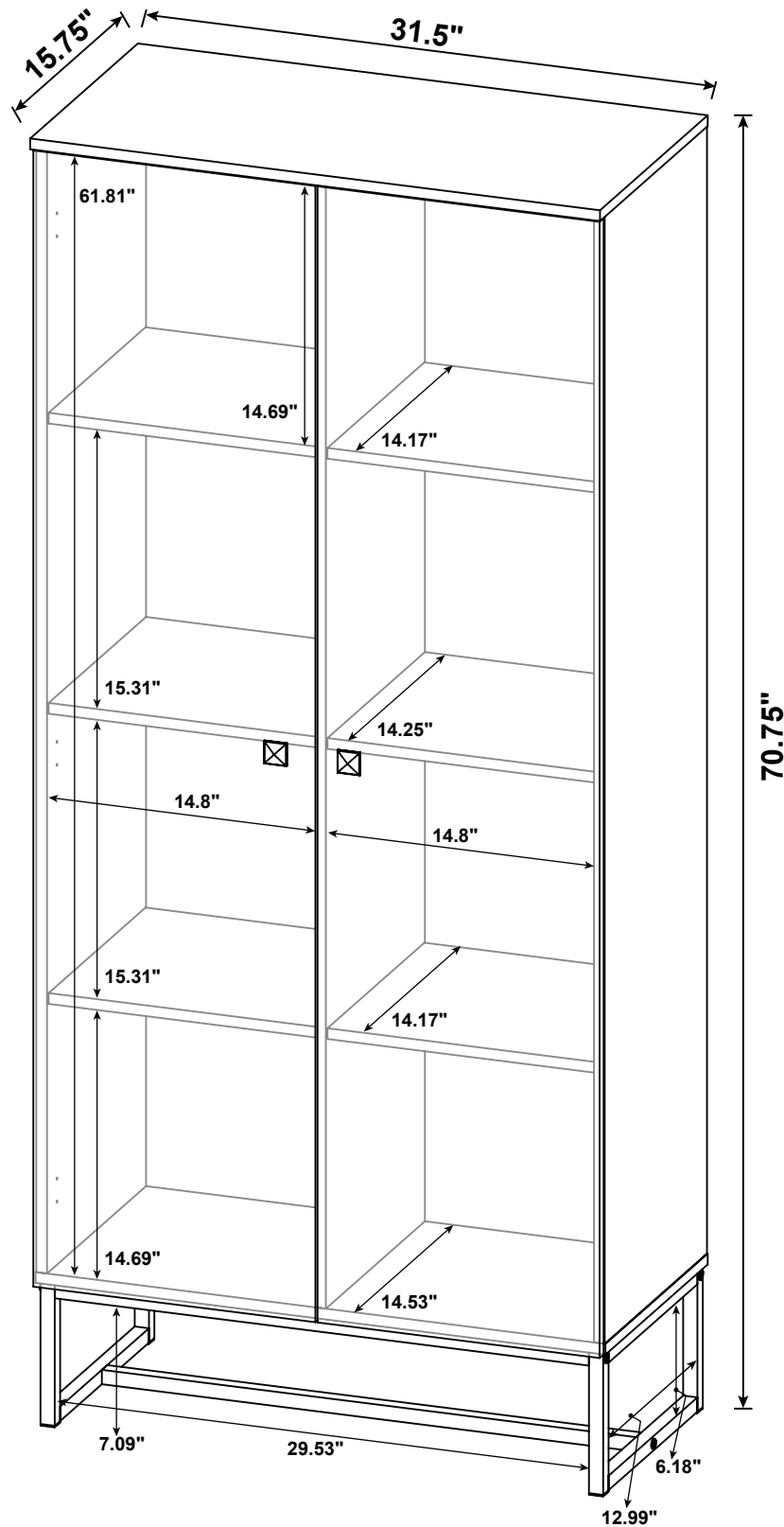

Note : Dimension tolerance  $\pm 5\%$

# ANTI-TIPPING INSTALLMENT INSTRUCTIONS

## FURNITURE TIPPING RESTRAINT

### WARNING

Injury may result from tipping furniture.  
This restraint may protect against tipping furniture.  
Do not allow children to climb on furniture.  
This restraint is not a substitute for proper adult supervision.  
Failure to detach this restraint before moving the furniture  
may result in injury and damage.

1. To attach the anti-tip strap, securely mount one end to the top of the case piece with the 5/8" screw.
2. Position the case piece against the wall in the desired location.
3. Pull the anti-tip strap taut and mark the position of where you will secure the other end on the wall.
4. Drill a 1-1/4" hole in the spot you marked.
5. Tap in plastic wall plug.
6. Fasten anti-tip strap with wall screw provided.

**(Please install the anti-tipping kit in the middle of the case piece if only have one set of anti-tipping kit.)**

