

ASSEMBLY INSTRUCTIONS
COASTER FINE FURNITURE



Fine Furniture for every stage of life

800829
WRITING DESK

REVISION 0 : 09/22/2017
REVISION 1 : 10/01/2019
REVISION 2 : 07/05/2022

ITEM:800829



ASSEMBLY INSTRUCTIONS

ASSEMBLY TIPS:

1. Remove hardware from box and sort by size.
2. Please check to see that all hardware and parts are present prior to start of assembly.
3. Please follow attached instructions in the same sequence as numbered to assure fast & easy assembly.



WARNING!

1. Don't attempt to repair or modify parts that are broken or defective. Please contact the store immediately.
2. This product is for home use only and not intended for commercial establishments.

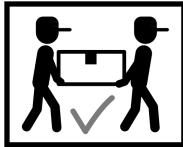

ASSEMBLY TIME 60 MINUTES

PARTS IDENTIFICATION

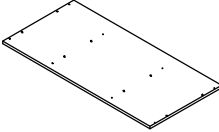
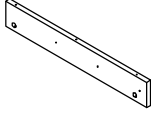
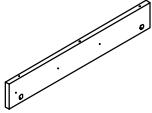
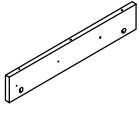
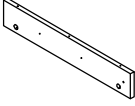
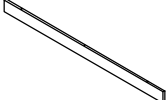
A	TOP BOARD		1PC
BN	LEFT BOARD		1PC
CN	RIGHT BOARD		1PC
DN	LEFT MIDDLE BOARD		1PC
EN	RIGHT MIDDLE BOARD		1PC
F	BACK BOARD		1PC

ITEM:800829

ASSEMBLY INSTRUCTIONS

PARTS IDENTIFICATION



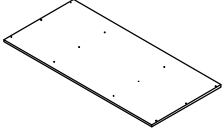
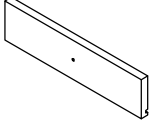
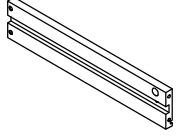
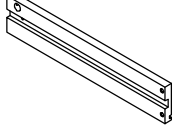
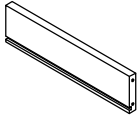
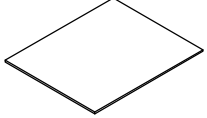
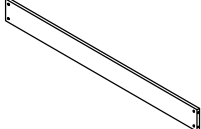

G	BOTTOM BOARD		1PC
H	DRAWER FRONT PANEL		2PCS
I	DRAWER LEFT PANEL		2PCS
J	DRAWER RIGHT PAENL		2PCS
K	DRAWER BACK PANEL		2PCS
L	DRAWER BOTTOM PANEL		2PCS
M	SUPPORT PANEL		1PC

ITEM:800829

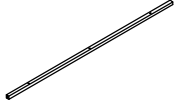
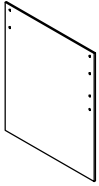

ASSEMBLY INSTRUCTIONS

PARTS IDENTIFICATION

N	SUPPORT CROSSBAR		2PCS
O	SIDE GLASS		2PCS
P	PLASTIC BAR		2PCS
Q	SLIDE RAIL		4PCS

















ITEM:800829

ASSEMBLY INSTRUCTIONS



ZN

HARDWARE IDENTIFICATION

1	CAM BOLT (38mm)		12PCS	12	LONG BOLT (1/4" x 38mm SR)		4PCS
2	LARGE CAM LOCK (ϕ 15mm)		8PCS	13	LARGE PLASTIC WASHER (ϕ 32mm)		16PCS
3	SMALL CAM LOCK (ϕ 12mm)		4PCS	14	SMALL PLASTIC WASHER (ϕ 15mm)		4PCS
4	LARGE WOOD DOWEL (8 x 30mm)		14PCS	15	WASHER (ϕ 13mm)		8PCS
5	SMALL WOOD DOWEL (6 x 30mm)		4PCS	16	CYLINDER NUT (ϕ 35mm)		8PCS
6	DOOR KNOB (ϕ 22 x 25mm)		2PCS	17	DENTAL-WROUGHT (1/4" x 38mm)		4PCS
7	LONG SCREW (ϕ 8 x 38mm)		20PCS	18	CAP (20 x 20mm SR)		4PCS
8	SHORT HANDLE SCREW (ϕ 8 x 12mm)		4PCS	19	NUT (ϕ 9.5 x 13mm)		4PCS
9	LONG HANDLE SCREW (ϕ 8 x 21mm)		2PCS	20	GLUE		1PC
10	SHORT BOLT (1/4" x 21mm SR)		4PCS	21	ALLEN WRENCH (4mm)		1PC
11	MEDIUM BOLT (1/4" x 28mm SR)		6PCS	22	SMALL SCREW		12PCS

ITEM:800829 ASSEMBLY INSTRUCTIONS



STEP 1 Do not tighten until each step is completed or instructed.

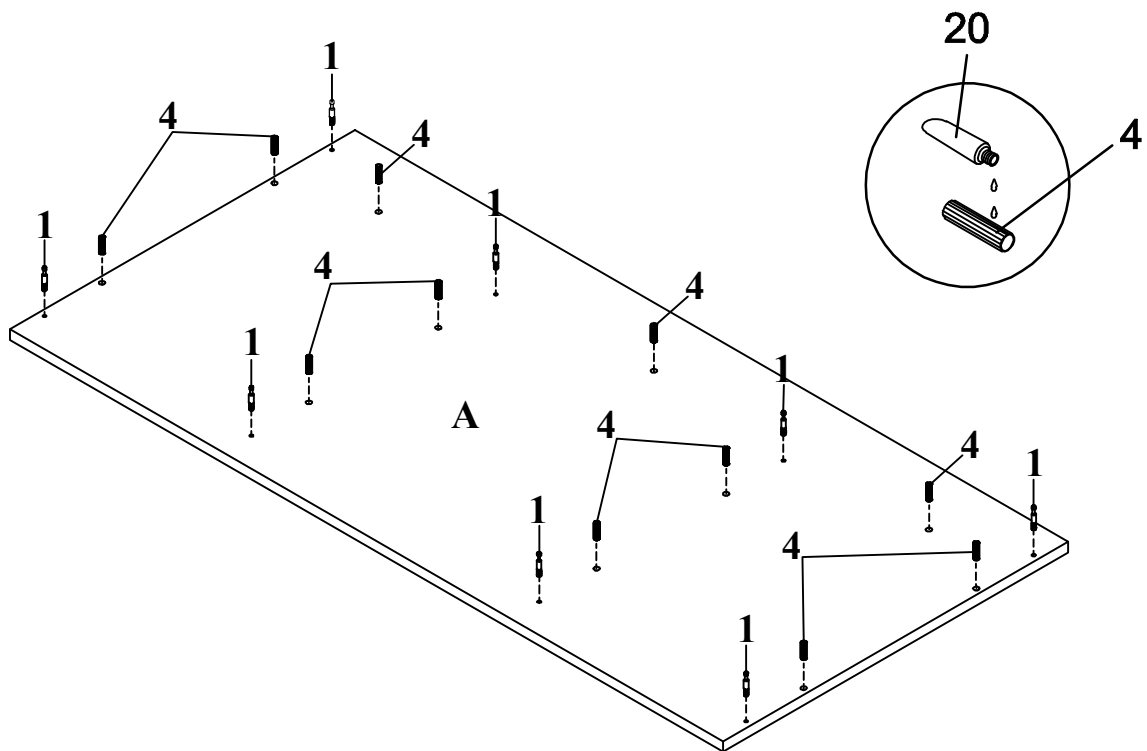

STEP 2

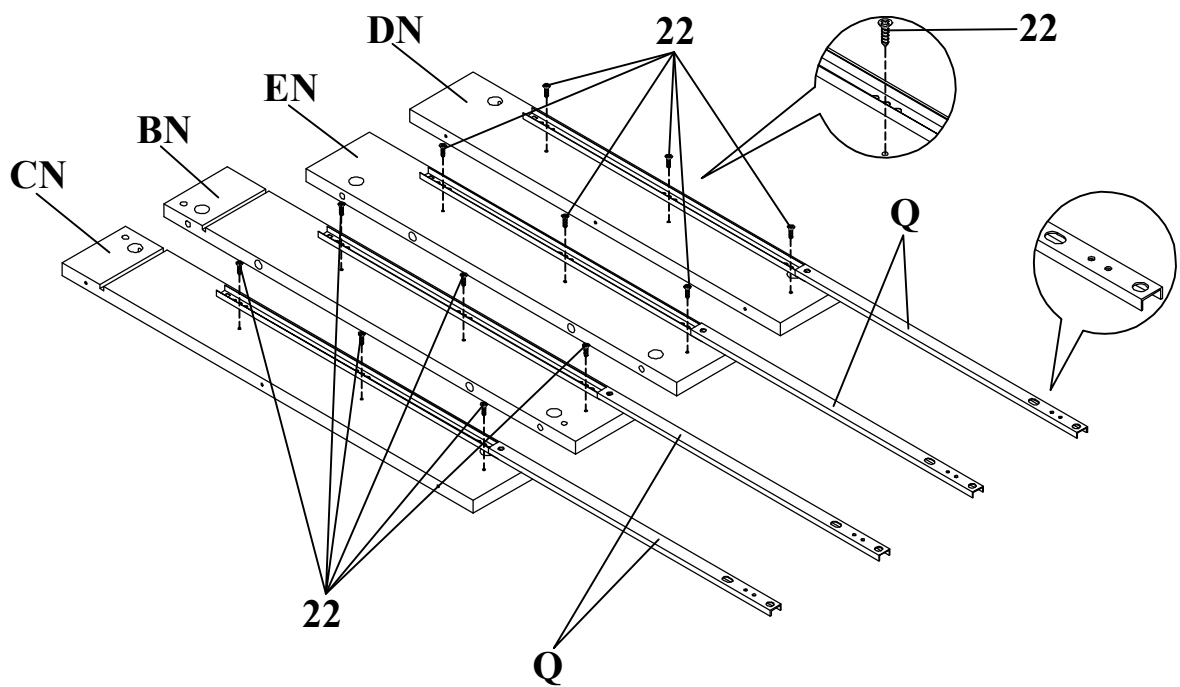

ITEM: 800829
ASSEMBLY INSTRUCTIONS
STEP 3

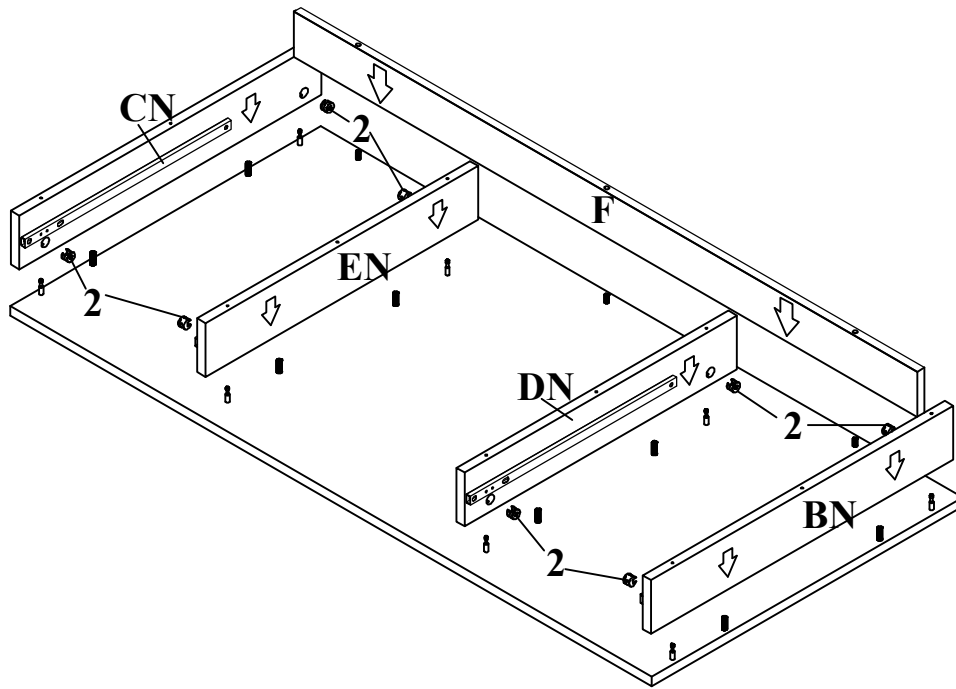

STEP 4

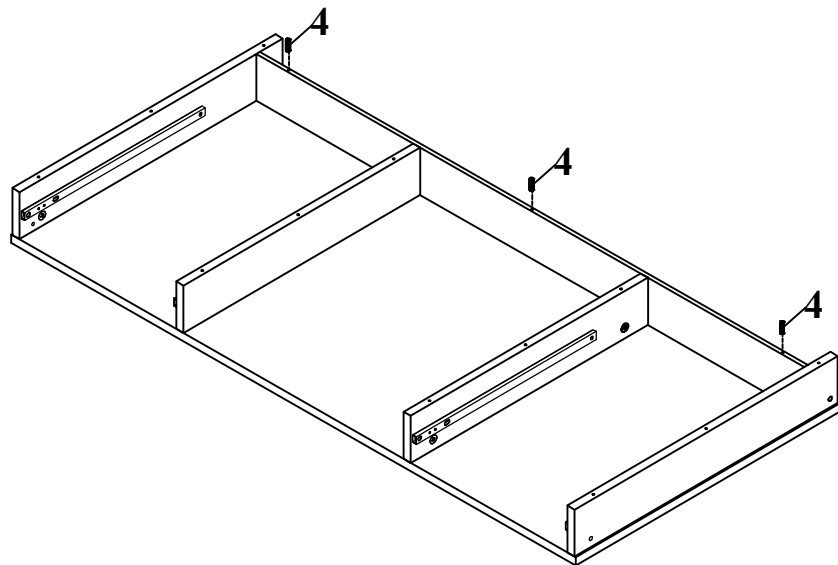

ITEM: 800829
ASSEMBLY INSTRUCTIONS
STEP 5

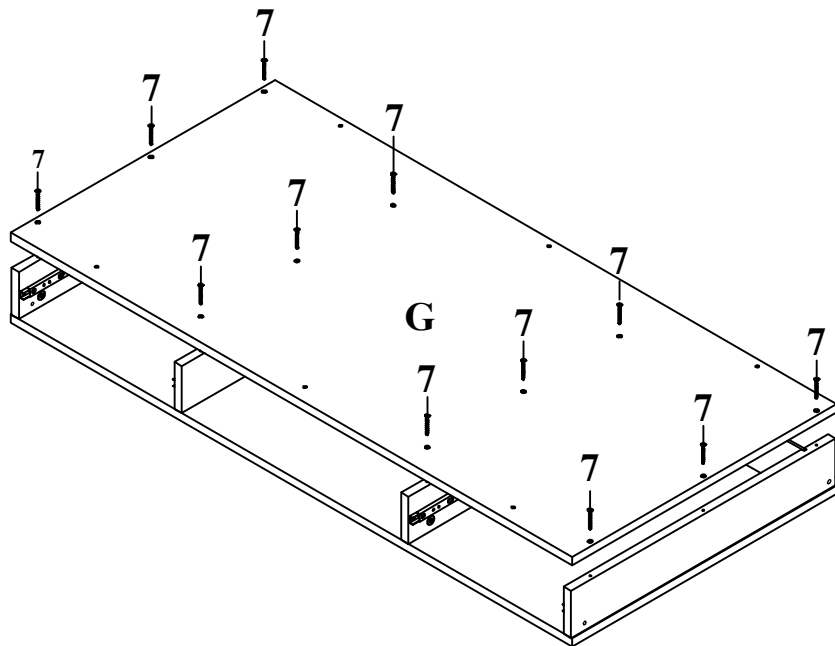

STEP 6

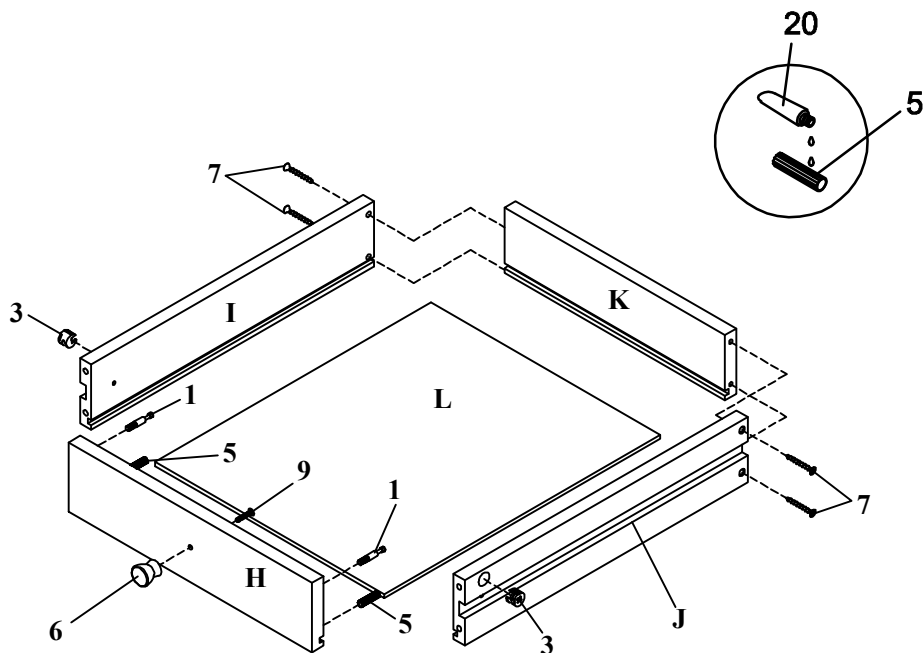

ITEM:800829

ASSEMBLY INSTRUCTIONS

STEP 7

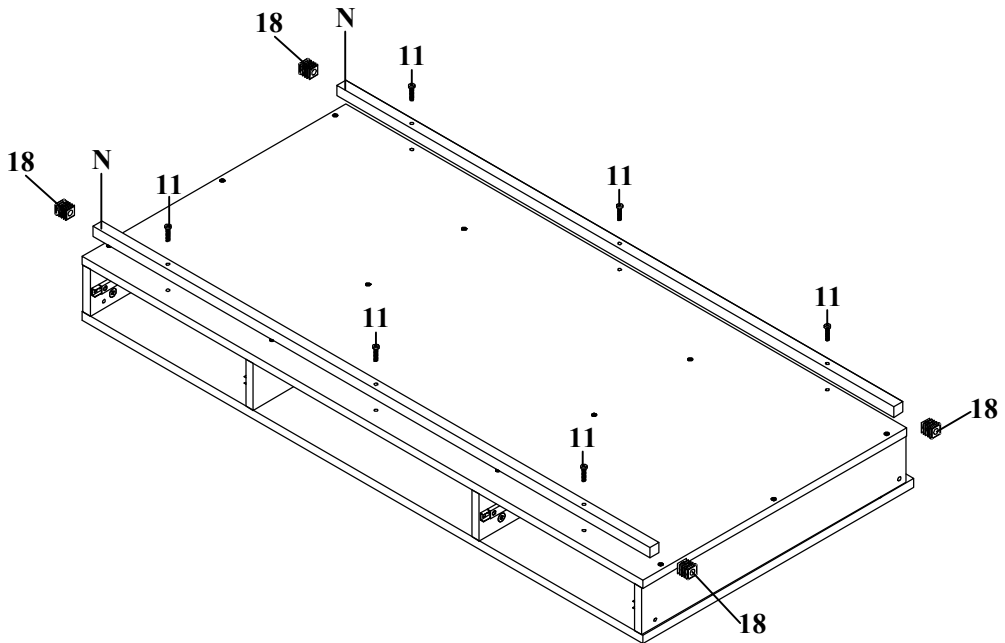

STEP 8

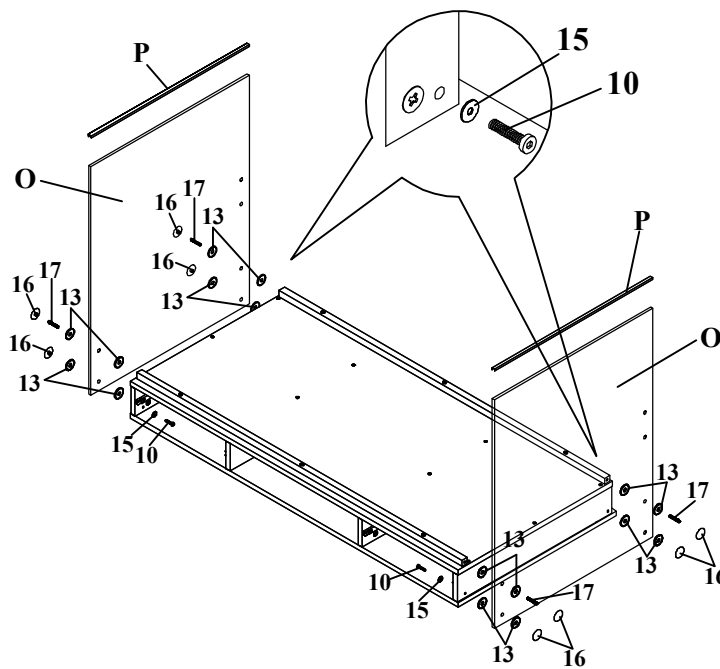

ITEM: 800829
ASSEMBLY INSTRUCTIONS
STEP 9

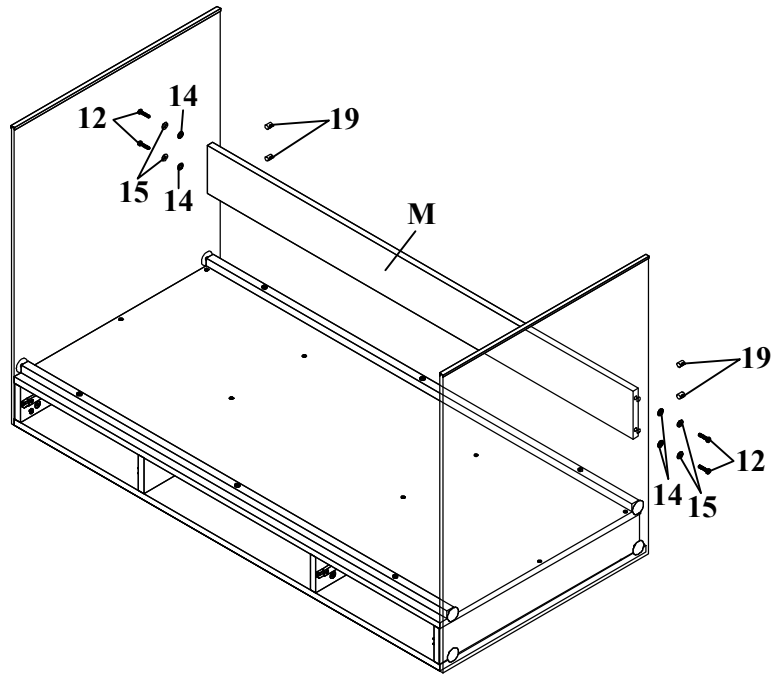

STEP 10

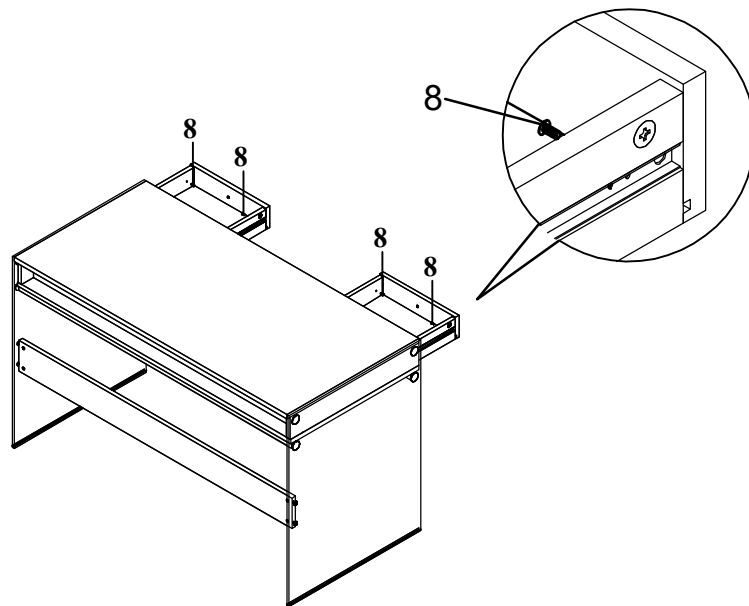

COMPLETE

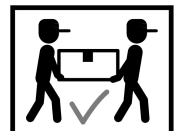
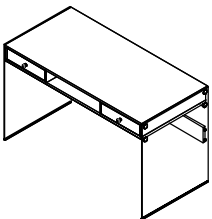

ITEM:800829 ASSEMBLY INSTRUCTIONS



Product Size : 1219 X 597 X 749 H (MM)
Product Size : 48" X 23 1/2" X 29 1/2"

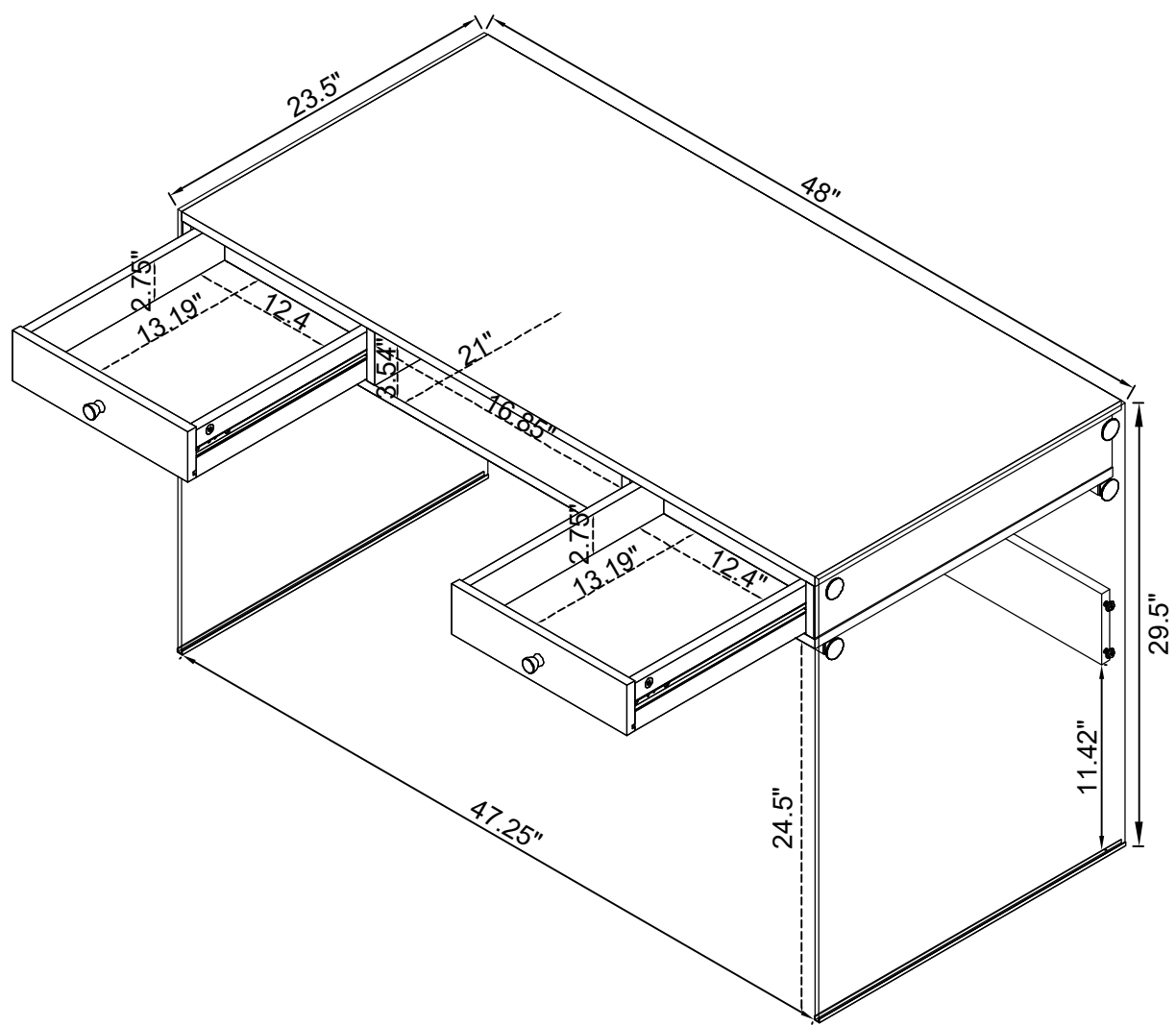

Note : Dimension tolerance $\pm 5\%$