

*ASSEMBLY INSTRUCTIONS
COASTER FINE FURNITURE*



Fine Furniture for every stage of life

882036
BOOKCASE

ITEM: **882036**

ASSEMBLY INSTRUCTIONS

ASSEMBLY TIPS:

1. Remove hardware from box and sort by size.
2. Please check to see that all hardware and parts are present prior to start of assembly.
3. Please follow attached instructions in the same sequence as numbered to assure fast & easy assembly.



WARNING!

1. Don't attempt to repair or modify parts that are broken or defective. Please contact the store immediately.
2. This product is for home use only and not intended for commercial establishments.

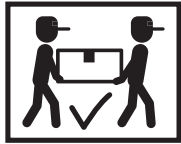

ASSEMBLY TIME

50 MINUTES

PARTS IDENTIFICATION

A SHELF

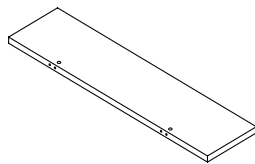

3 PCS

D FRONT PANEL

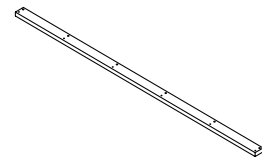

2 PCS

B BOTTOM SHELF

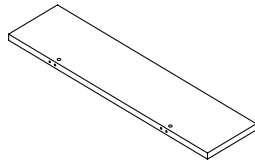

1 PC

E BRACE

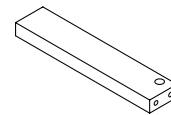





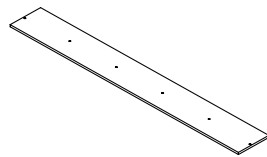

4 PCS

C BACK PANEL

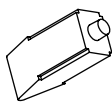

2 PCS

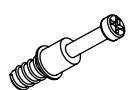
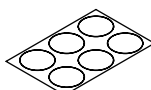
HARDWARE IDENTIFICATION

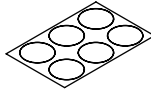
Z							
NO	DESCRIPTION	FIGURE	Q'TY	NO	DESCRIPTION	FIGURE	Q'TY
1	GLUE 40g		1 PC	5	SCREW Ø4.5x42mm SR		12 PCS
2	WOODEN DOWEL Ø8x30mm		32 PCS	6	PLASTIC FEET Ø15mm		4 PCS
3	CAM BOLT Ø7x35.5mm SR		12 PCS	7	STICKER Ø20mm		2 PCS
4	CAM LOCK Ø15x12mm SR		12 PCS	8	STICKER Ø20mm		3 PCS

NOTE:

Phillips head screw driver is required in the assembly process; however, manufacturer does not provide this item.

ITEM: 882036

COASTER
FINE FURNITURE

STEP 1

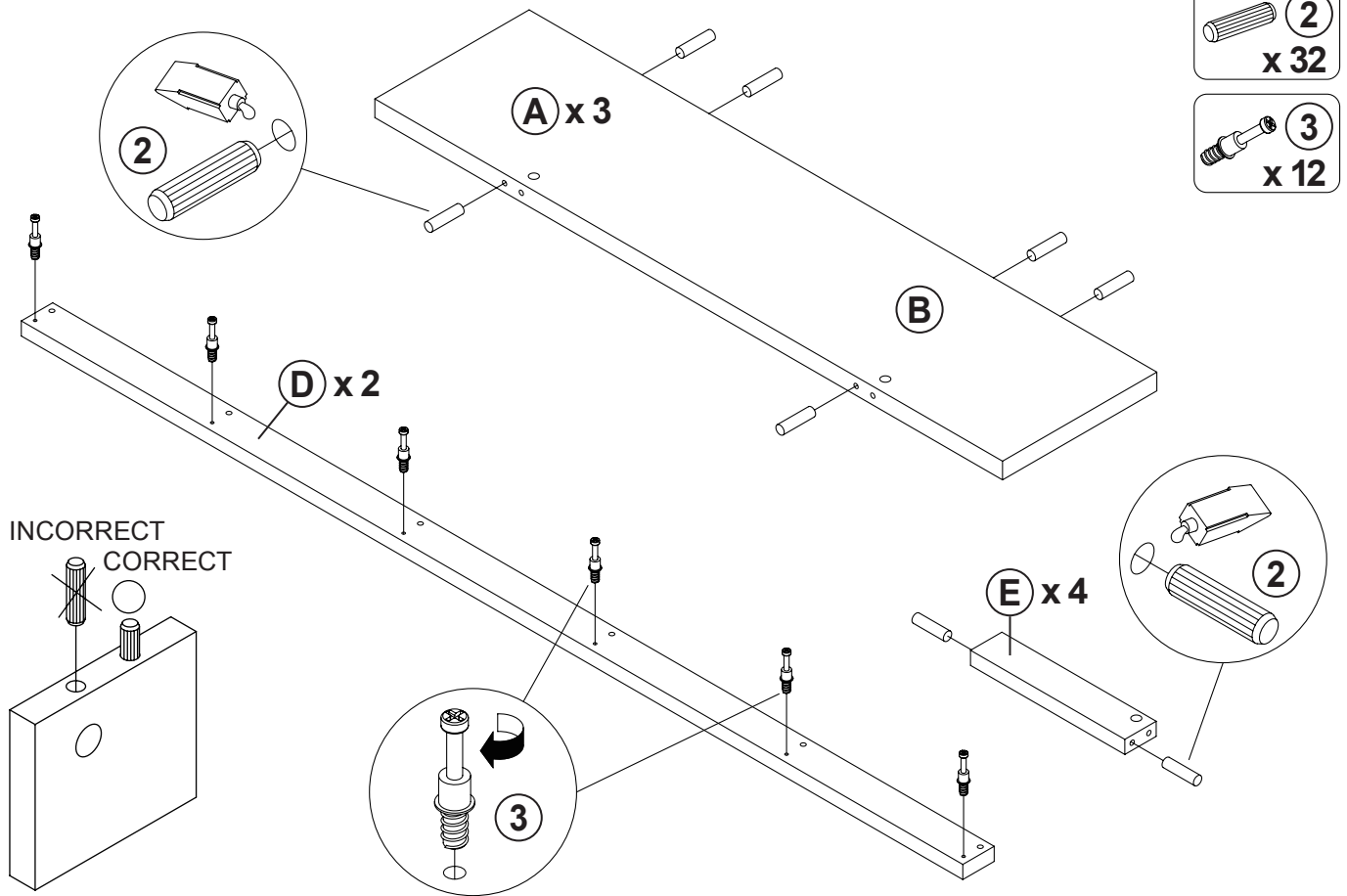

STEP 2

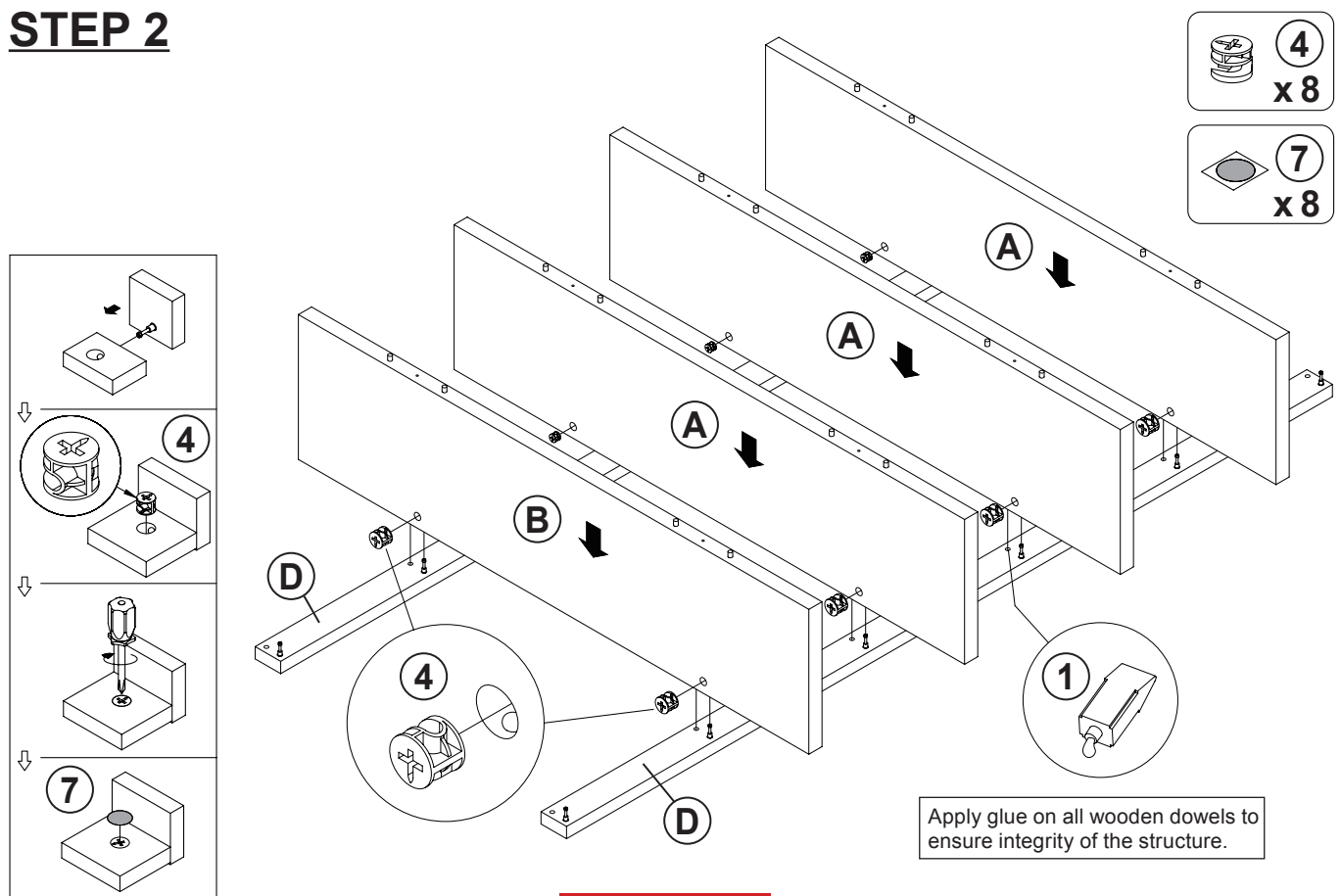



Apply glue on all wooden dowels to ensure integrity of the structure.

ITEM: 882036



COASTER
FINE FURNITURE

STEP 3

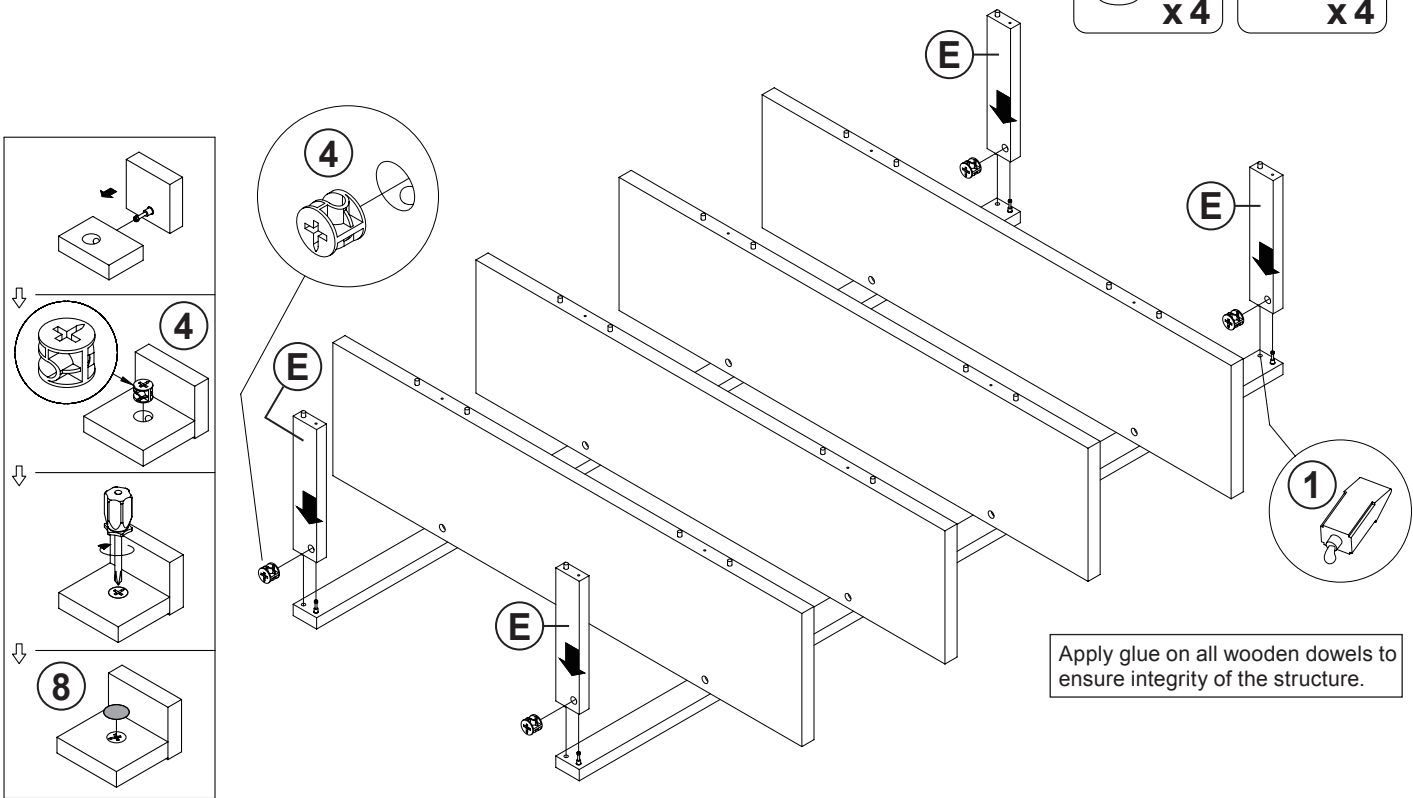
-  4 x 4
-  8 x 4



STEP 4

-  5 x 12
-  8 x 12

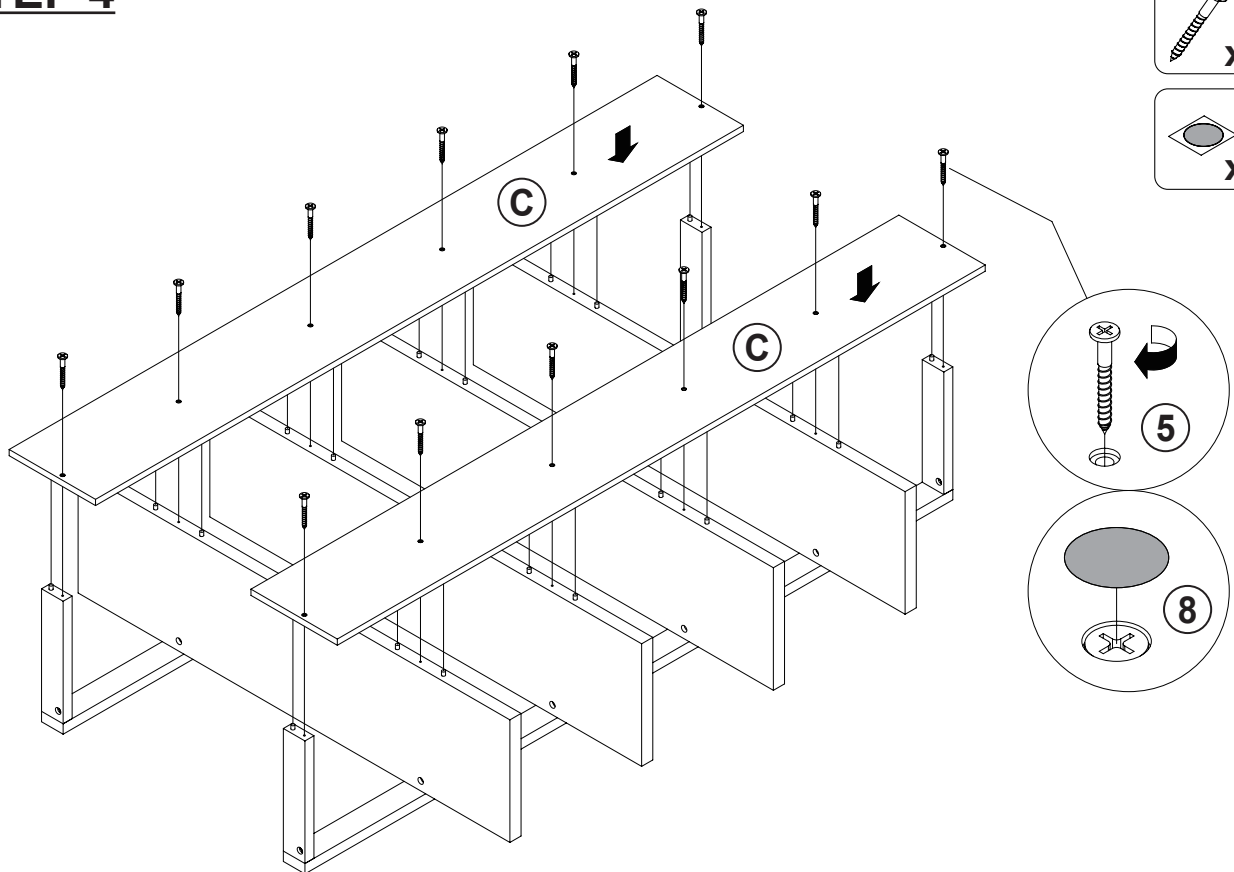

ITEM: 882036

COASTER
FINE FURNITURE

STEP 5

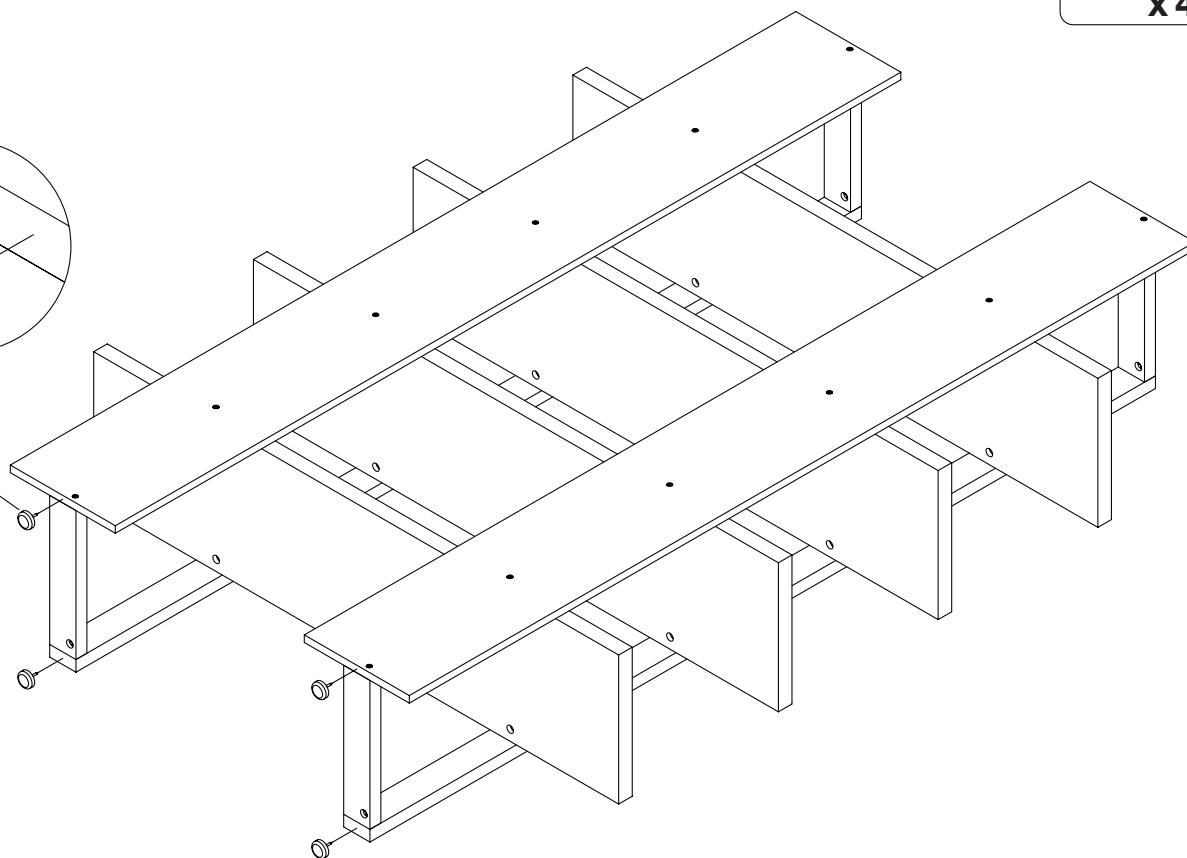
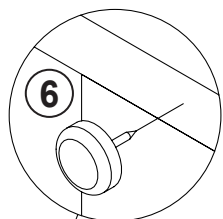
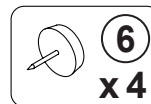

STEP 6

COMPLETE

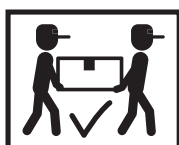
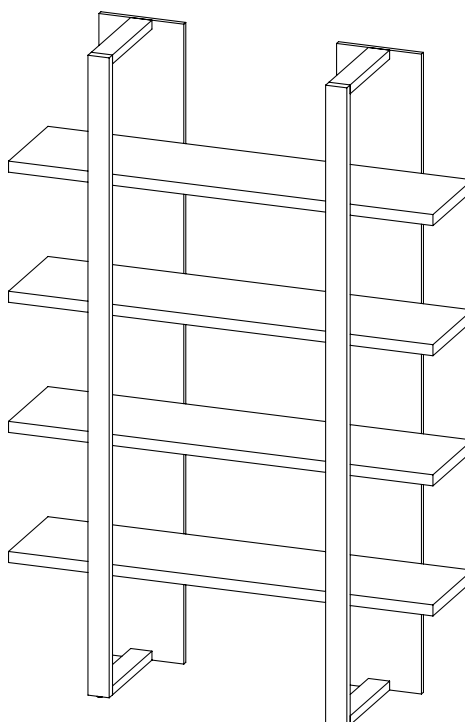

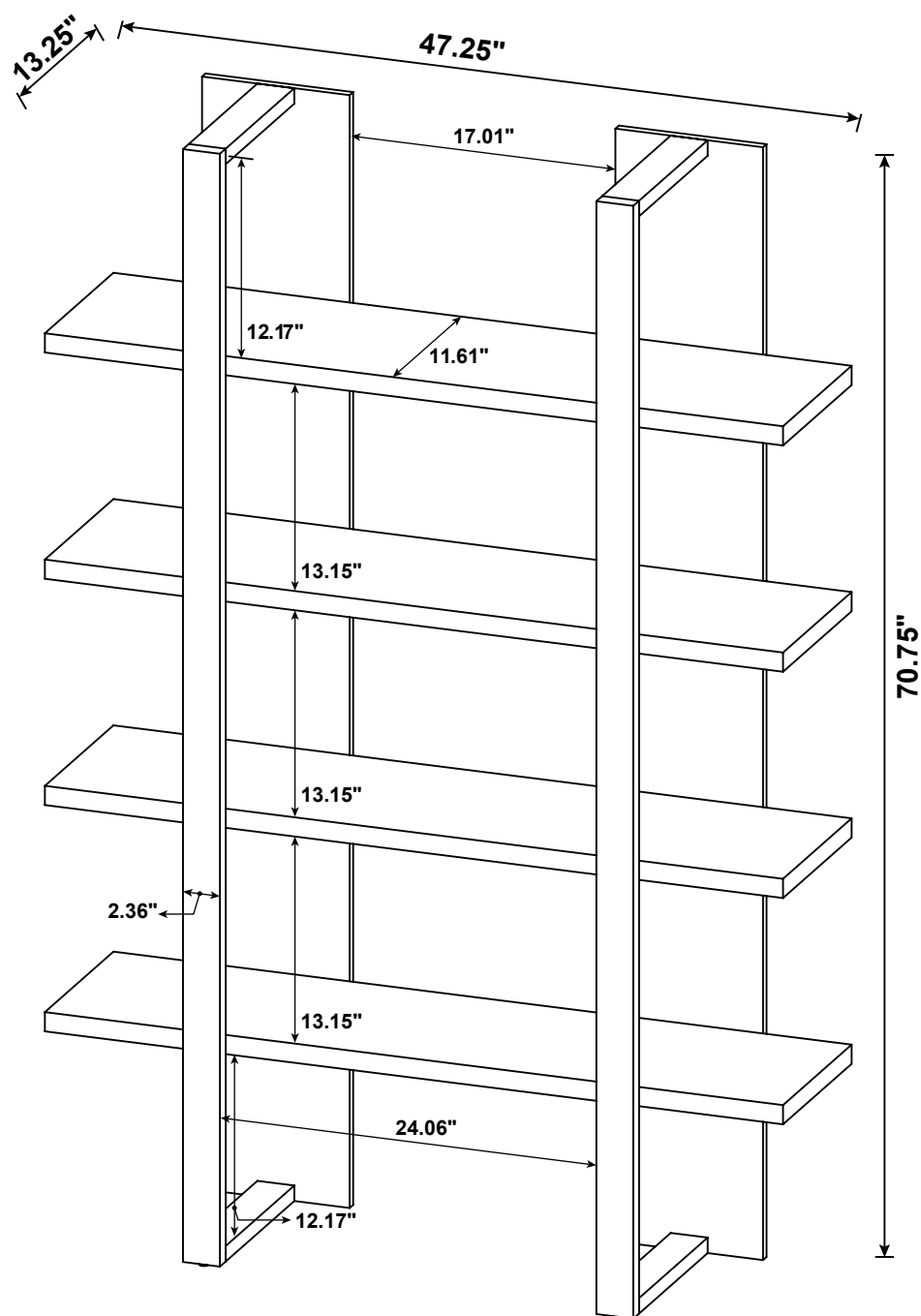

Note : Dimension tolerance $\pm 5\%$

ANTI-TIPPING INSTALLMENT INSTRUCTIONS

FURNITURE TIPPING RESTRAINT

WARNING

Injury may result from tipping furniture.
This restraint may protect against tipping furniture.
Do not allow children to climb on furniture.
This restraint is not a substitute for proper adult supervision.
Failure to detach this restraint before moving the furniture
may result in injury and damage.

1. To attach the anti-tip strap, securely mount one end to the top of the case piece with the 5/8" screw.
2. Position the case piece against the wall in the desired location.
3. Pull the anti-tip strap taut and mark the position of where you will secure the other end on the wall.
4. Drill a 1-1/4" hole in the spot you marked.
5. Tap in plastic wall plug.
6. Fasten anti-tip strap with wall screw provided.

(Please install the anti-tipping kit in the middle of the case piece if only have one set of anti-tipping kit.)

