

ASSEMBLY INSTRUCTIONS
COASTER FINE FURNITURE

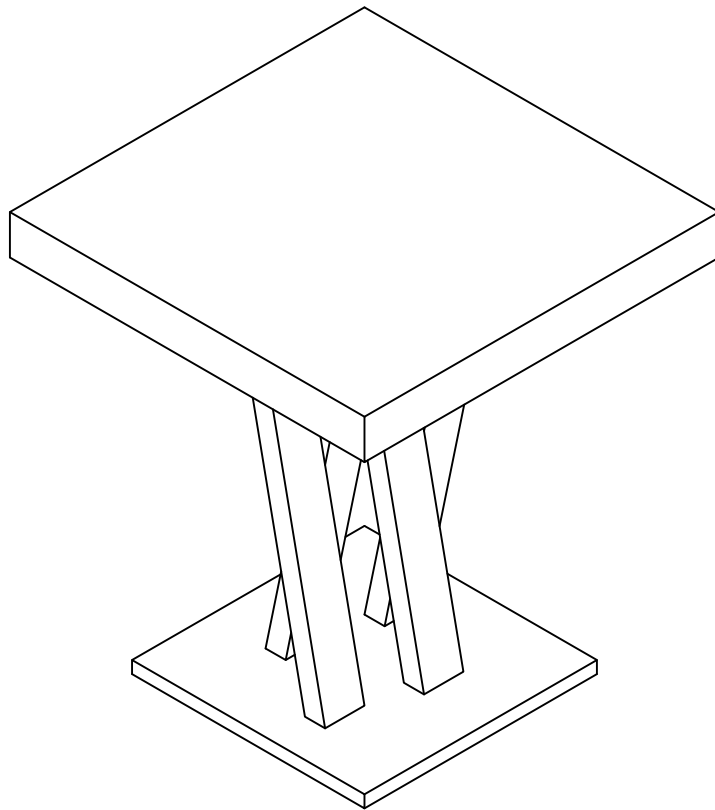

Fine Furniture for every stage of life

100520
Bar Table

ITEM: 100520



ASSEMBLY INSTRUCTIONS

ASSEMBLY TIPS:

1. Remove hardware from box and sort by size.
2. Please check to see that all hardware and parts are present prior to start of assembly.
3. Please follow attached instructions in the same sequence as numbered to assure fast & easy assembly.

Warning !!

1. Don't attempt to repair or modify parts that are broken or defective. Please contact the store immediately.
2. This product is for home use only and not intended for commercial establishment.



ASSEMBLY TIME

30 MINUTES



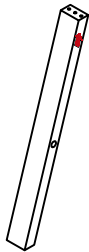
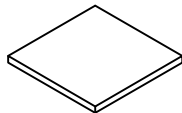
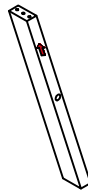
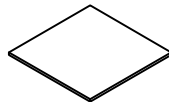
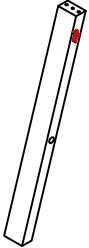
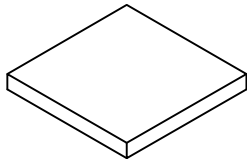
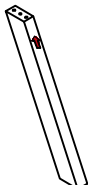

PARTS IDENTIFICATION

(A) LEG		1 PC	(E) BOTTOM PANEL		1 PC
(B) LEG		1 PC	(F) CONNECTING PANEL		1 PC
(C) LEG		1 PC	(G) TOP PANEL		1 PC
(D) LEG		1 PC			

ITEM: **100520**

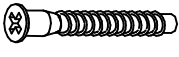

HARDWARE IDENTIFICATION

1	FLAT-HEAD SCREW	M6 × 30mm		4pcs
2	WOOD SCREW	∅7x48mm		8pcs
3	WOOD SCREW	∅7x58mm		8pcs
4	SHORT DOWEL	∅8 × 25mm		11pcs
5	GLUE			1pc

ITEM: 100520

ASSEMBLY INSTRUCTIONS

STEP 1

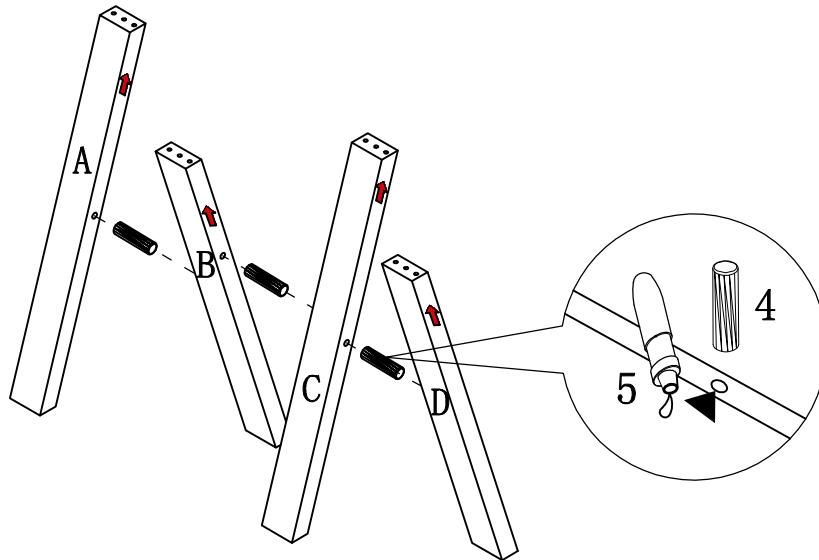

STEP 2

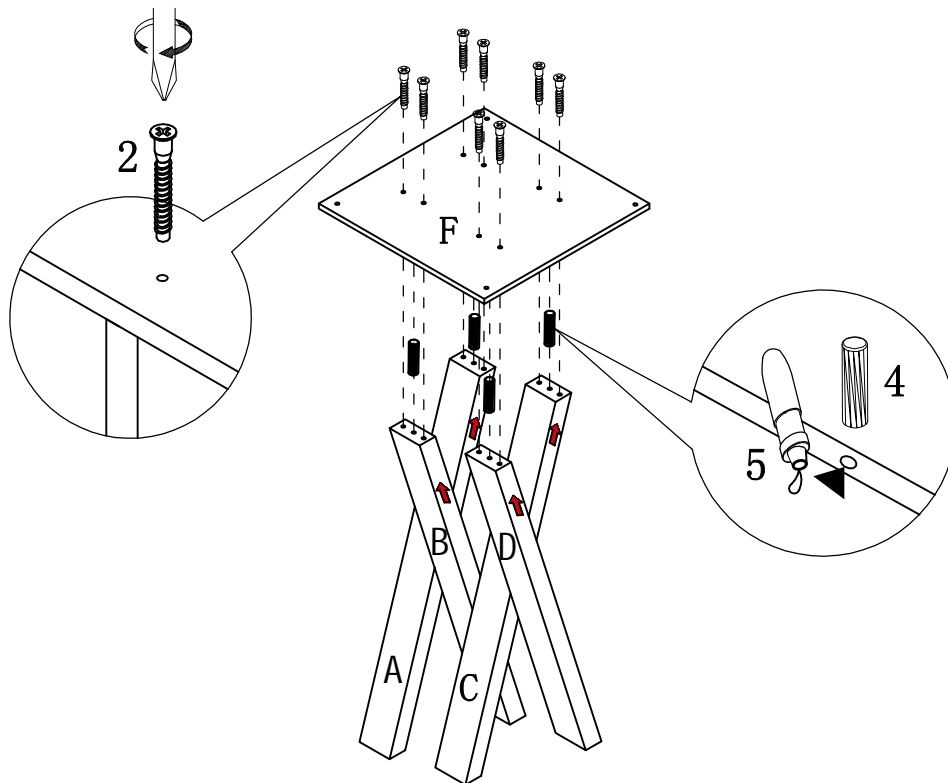

ITEM: **100520**

ASSEMBLY INSTRUCTIONS



STEP 3

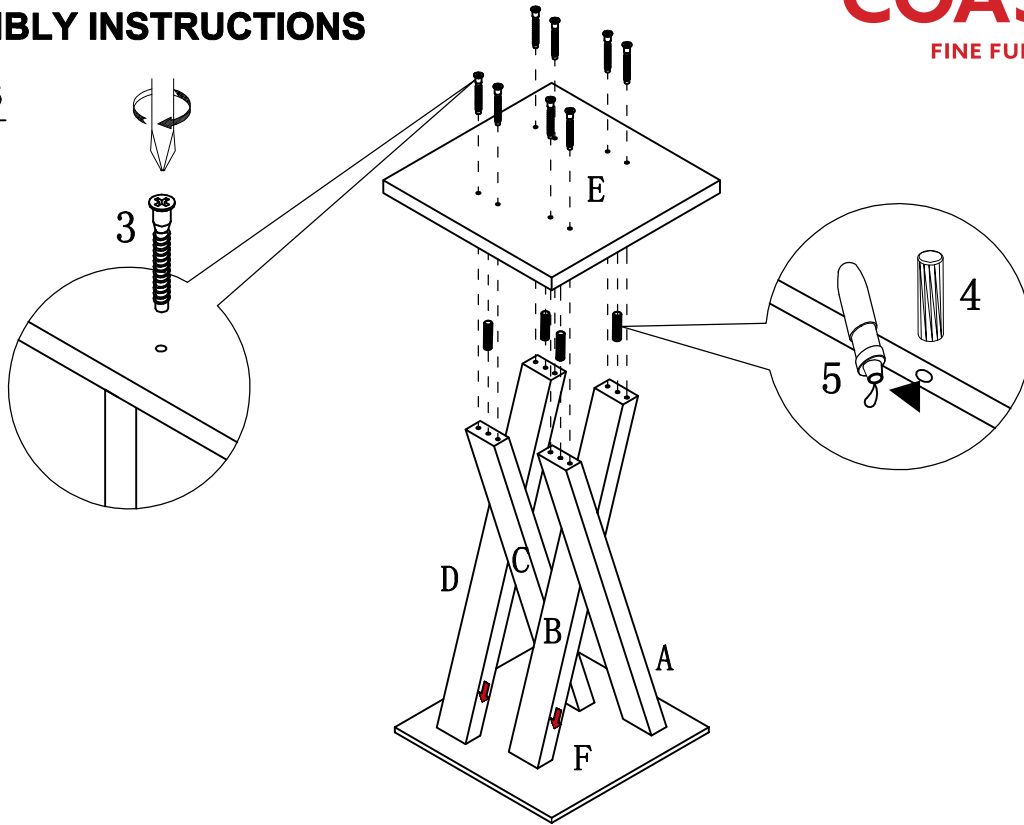

STEP 4

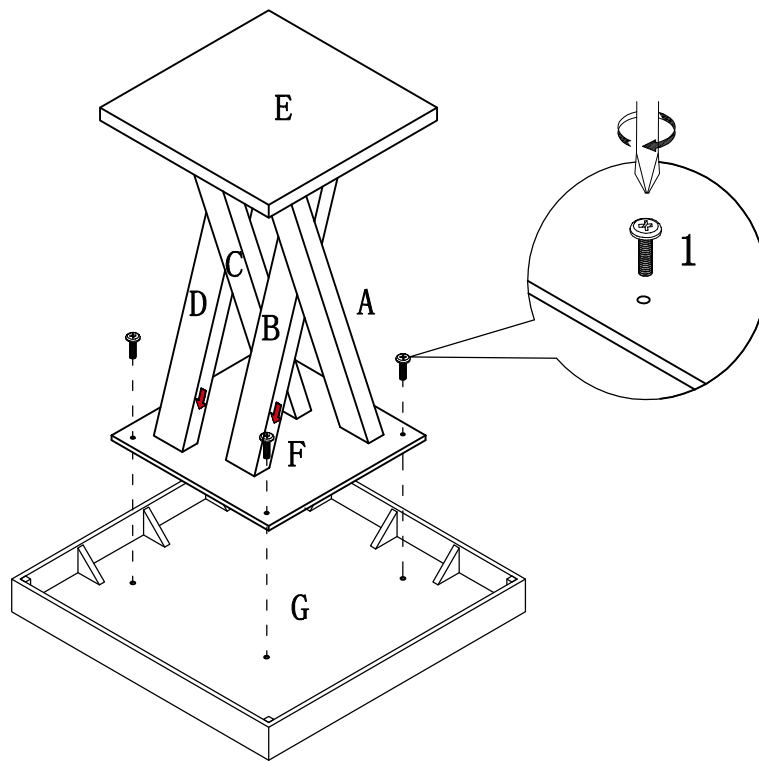

ITEM: **100520**

DIMENSION

