



ASSEMBLY INSTRUCTIONS COASTER FINE FURNITURE



Fine Furniture for every stage of life

509882

LOVESEAT

REVISION 0: 03/26/2022
REVISION 1: 07/14/2022

PAGE 1 OF 4

COASTERFURNITURE.COM

ITEM : 509882



ASSEMBLY INSTRUCTIONS

ASSEMBLY TIPS:

- 1.Remove hardware from box and sort by size.
- 2.Please check to see that all hardware and parts are present prior to start of assembly.
- 3.Please follow attached instruction in the same sequence as numbered to assure fast & easy assembly.



WARNING!

- 1.Don't attempt to repair or modify parts that are broken or defective. Please contact the store immediately.
- 2.This product is for home use only and not intended for commercial establishment.

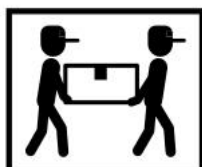

ASSEMBLY TIME

10 MINUTES

PARTS IDENTIFICATION

A

LOVESEAT

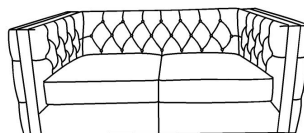

1PC

B

LEG



4PCS

C

PILLOW



2PCS

HARDWARE IDENTIFICATION

1

Allen wrench
5*23*73mm



1 PC

3

Washer M8
21*21*1mm



8 PCS

2

Wood screw
30*10*10mm

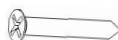

8 PCS

ITEM : 509882
ASSEMBLY INSTRUCTIONS
STEP 1

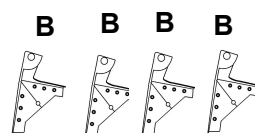
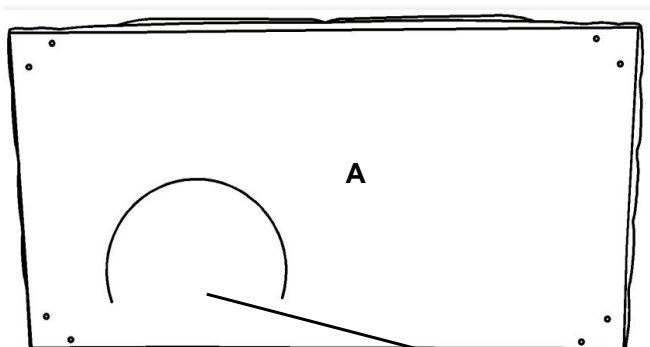

STEP 2

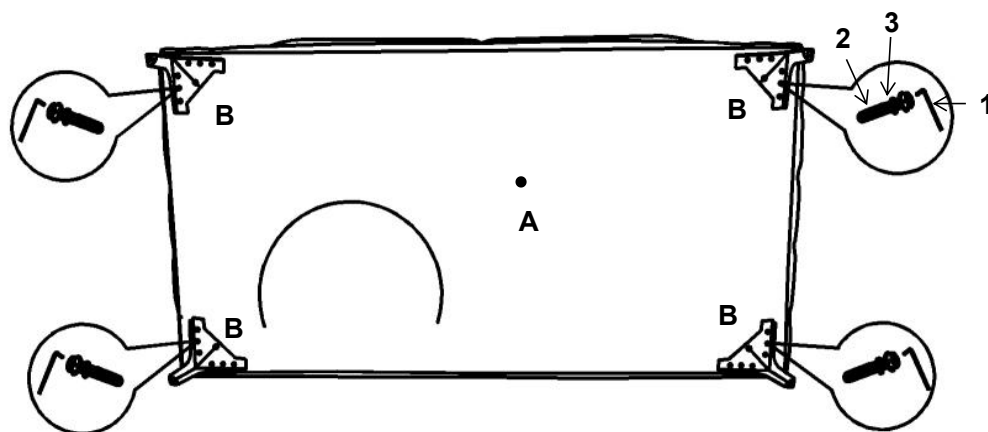

STEP 3

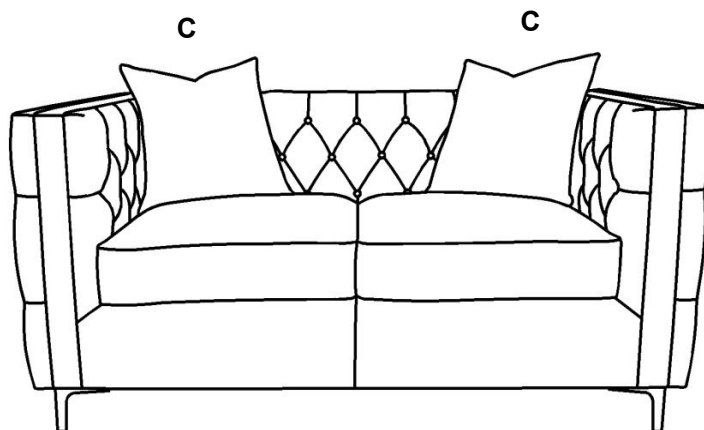

ITEM : 509882

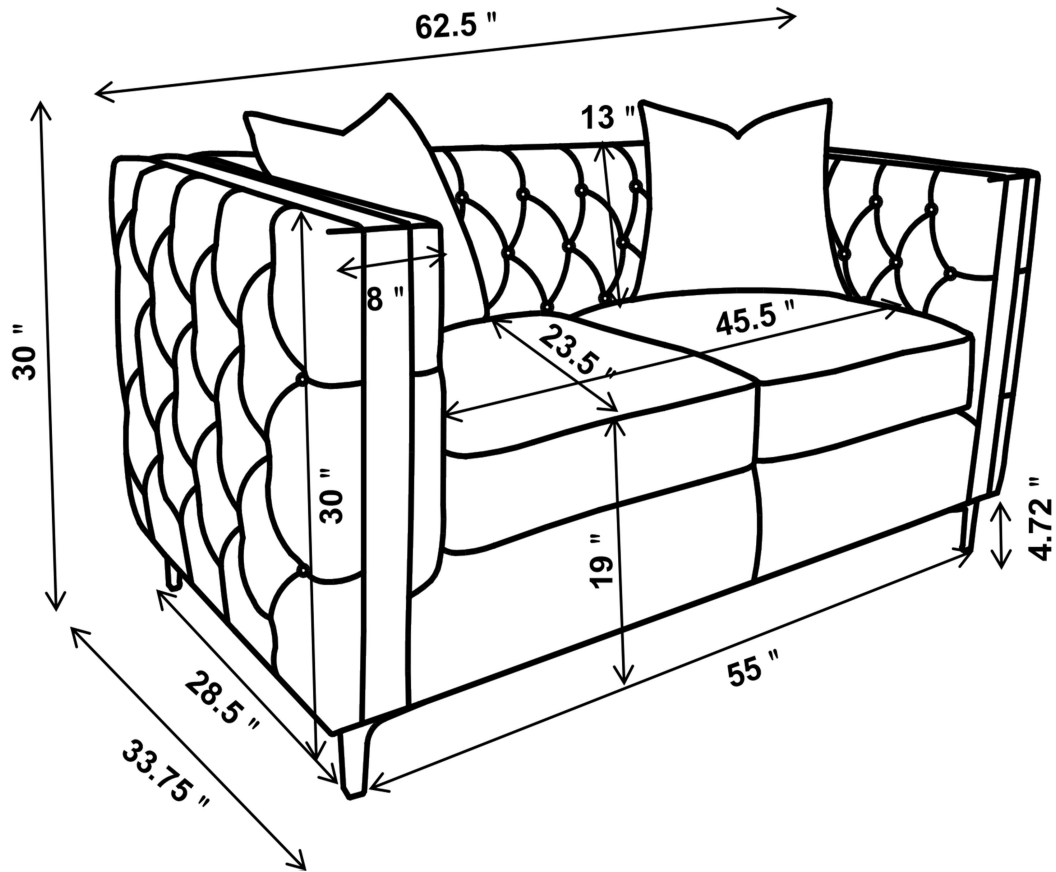

NOTE: Dimension tolerance $\pm 5\%$

