



ASSEMBLY INSTRUCTIONS COASTER FINE FURNITURE



Fine Furniture for every stage of life

509883

CHAIR

ITEM : 509883



ASSEMBLY INSTRUCTIONS

ASSEMBLY TIPS:

- 1.Remove hardware from box and sort by size.
- 2.Please check to see that all hardware and parts are present prior to start of assembly.
- 3.Please follow attached instruction in the same sequence as numbered to assure fast & easy assembly.



WARNING!

- 1.Don't attempt to repair or modify parts that are broken or defective. Please contact the store immediately.
- 2.This product is for home use only and not intended for commercial establishment.

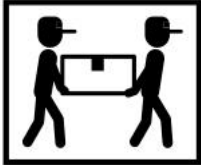



ASSEMBLY TIME

10 MINUTES

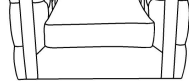
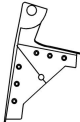
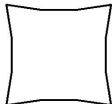
PARTS IDENTIFICATION

A	CHAIR		1PC
B	LEG		4PCS
C	PILLOW		1PC

HARDWARE IDENTIFICATION

1	Allen wrench 5*23*73mm		1 PC	3	Washer M8 21*21*1mm		8 PCS
2	Wood screw 30*10*10mm		8 PCS				

ITEM : 509883
ASSEMBLY INSTRUCTIONS
STEP 1

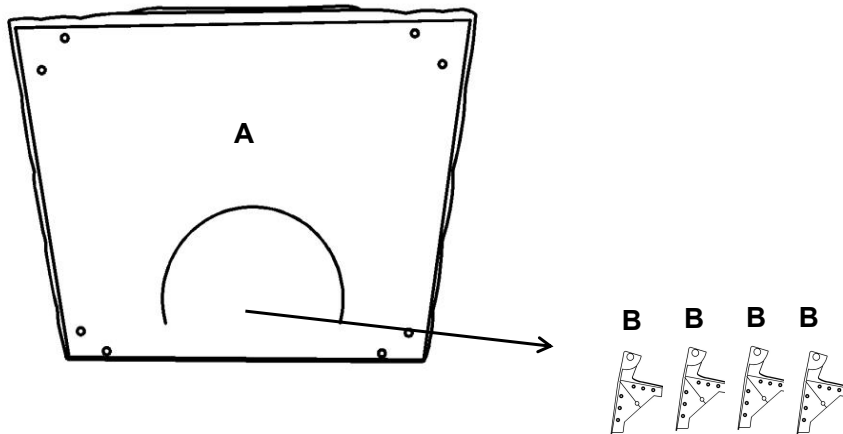

STEP 2

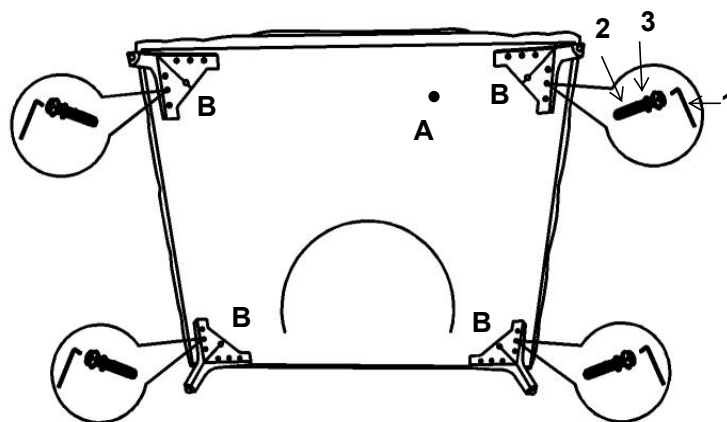

STEP 3

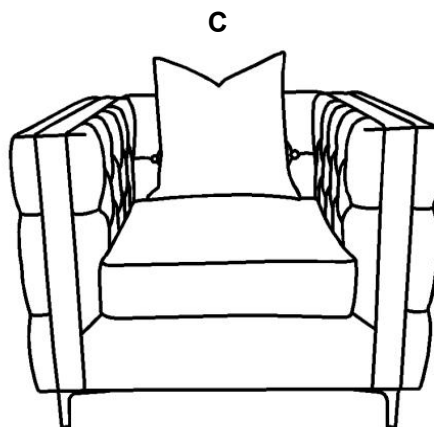

ITEM : 509883

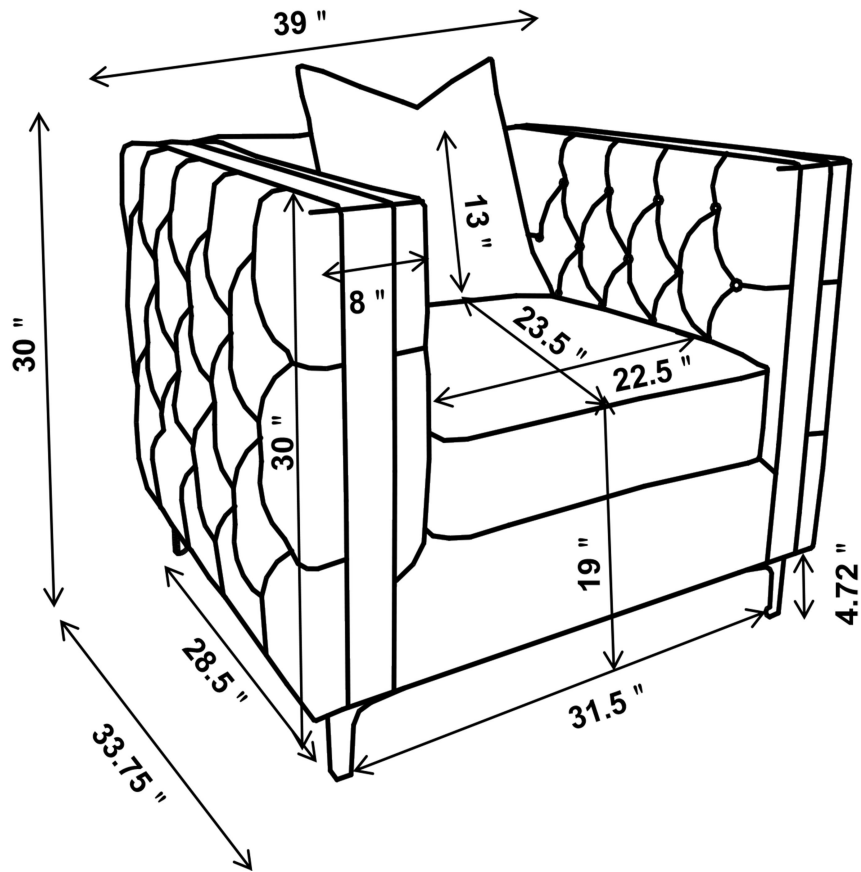

NOTE: Dimension tolerance $\pm 5\%$

