

ASSEMBLY INSTRUCTIONS
COASTER FINE FURNITURE



Fine Furniture for every stage of life

182105
BAR UNIT

ITEM: 182105

ASSEMBLY INSTRUCTIONS

ASSEMBLY TIPS:

1. Remove hardware from box and sort by size.
2. Please check to see that all hardware and parts are present prior to start of assembly.
3. Please follow attached instructions in the same sequence as numbered to assure fast & easy assembly.



WARNING!







1. Don't attempt to repair or modify parts that are broken or defective. Please contact the store immediately.
2. This product is for home use only and not intended for commercial establishments.

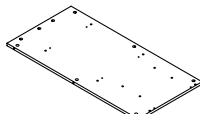
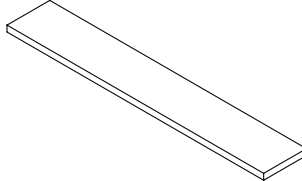
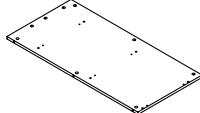
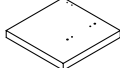

ASSEMBLY TIME

90 MINUTES

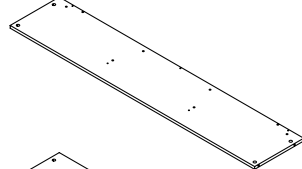
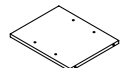
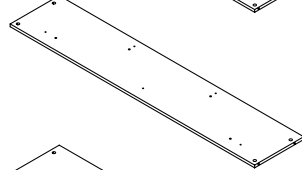
PARTS IDENTIFICATION

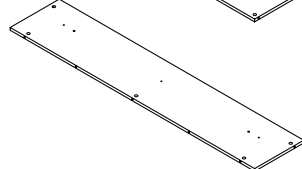
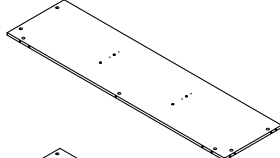
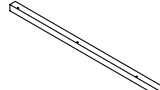
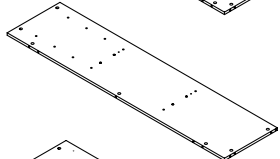
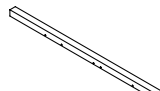
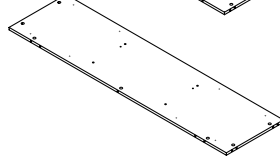
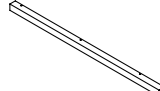
A	LEFT SIDE PANEL		1 PC	J	LARGE TOP PANEL		1 PC
B	RIGHT SIDE PANEL		1 PC	K	LEFT SMALL TOP PANEL		1 PC
C	UPPER DIVIDER PANEL		3 PCS	L	RIGHT SMALL TOP PANEL		1 PC
D	LOWER DIVIDER PANEL		1 PC	M	LOWER BACK PANEL		1 PC
E	SMALL DIVIDER PANEL		3 PCS	N	MIDDLE BACK PANEL		1 PC
F	SMALL CROSS PANEL		8 PCS	O	UPPER BACK PANEL		1 PC
G	BOTTOM PANEL		1 PC	P	LEFT FRONT LEG		1 PC
H	MIDDLE CROSS PANEL		1 PC	Q	LEFT BACK LEG		1 PC
I	UPPER CROSS PANEL		1 PC	R	RIGHT FRONT LEG		1 PC

NOTE:

Phillips head screw driver is required in the assembly process; however, manufacturer does not provide this item.

ITEM: 182105

S RIGHT BACK LEG

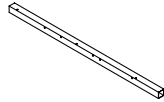





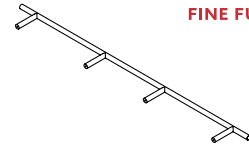





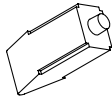
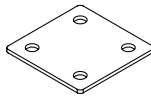
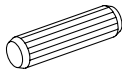

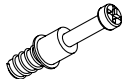
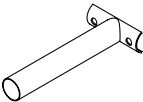

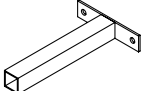
1 PC

T FOOTREST

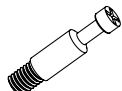

1 PC

HARDWARE IDENTIFICATION

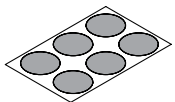
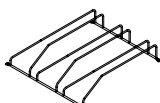
Z NO	DESCRIPTION	FIGURE	Q'TY	NO	DESCRIPTION	FIGURE	Q'TY
1	GLUE 40g		1 PC	12	SUPPORT PLATE SR		2 PCS
2	WOODEN DOWEL Ø8x30mm		58 PCS	13	SCREW Ø4x15mm SR		16 PCS
3	CAM BOLT Ø7x35.5mm SR		38 PCS	14	FOOTREST SUPPORT LEG Ø25mm BLK		3 PCS
4	CAM LOCK Ø15x12mm SR		60 PCS	15	SUPPORT LEG 129mm BLK		2 PCS
5	SCREW Ø4.5x42mm SR		8 PCS	16	SCREW Ø4x15mm BLK		4 PCS
6	WOODEN DOWEL Ø8x50mm		16 PCS	17	FLOOR PROTECTOR 38x38mm		4 PCS
7	CAM BOLT Ø7x31.5mm BLK		22 PCS	18	FLOOR PROTECTOR 18x18mm		2 PCS
8	BOLT M6x38mm BLK		4 PCS	19	FLOOR PROTECTOR Ø25mm		5 PCS
9	BOLT M6x15mm BLK		6 PCS	20	SCREW DRIVER		1 PC
10	ALLEN WRENCH 4mm SR		1 PC	21	STICKER Ø20mm		10 PCS
11	GLASS HOLDER		2 PCS				

Z11,Z14,Z15 not included in blister packaging.

NOTE:

Phillips head screw driver is required in the assembly process; however, manufacturer does not provide this item.

ITEM: **182105**

COASTER
FINE FURNITURE

STEP 1

- 2** x 23
- 4** x 2
- 6** x 12

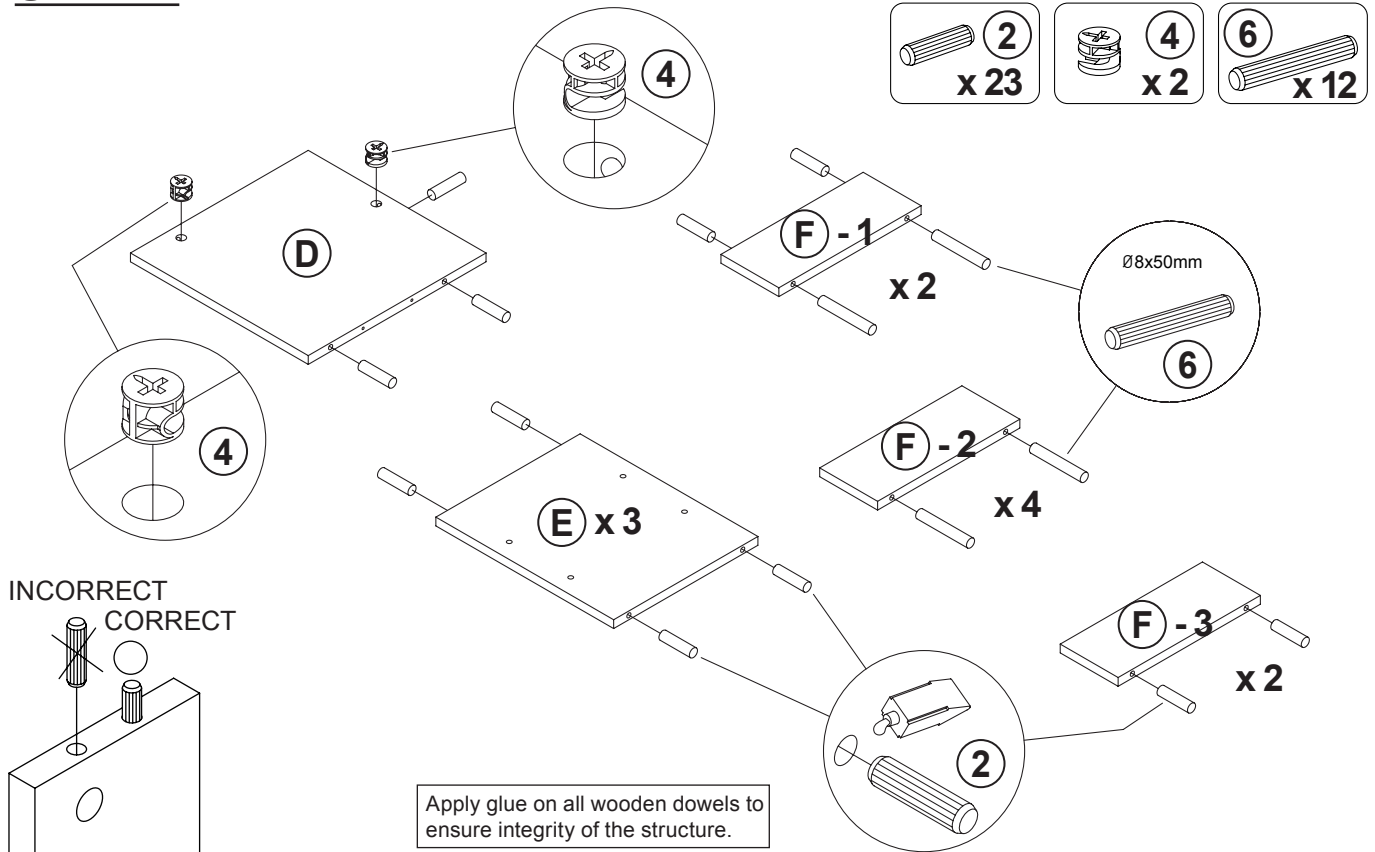

STEP 2

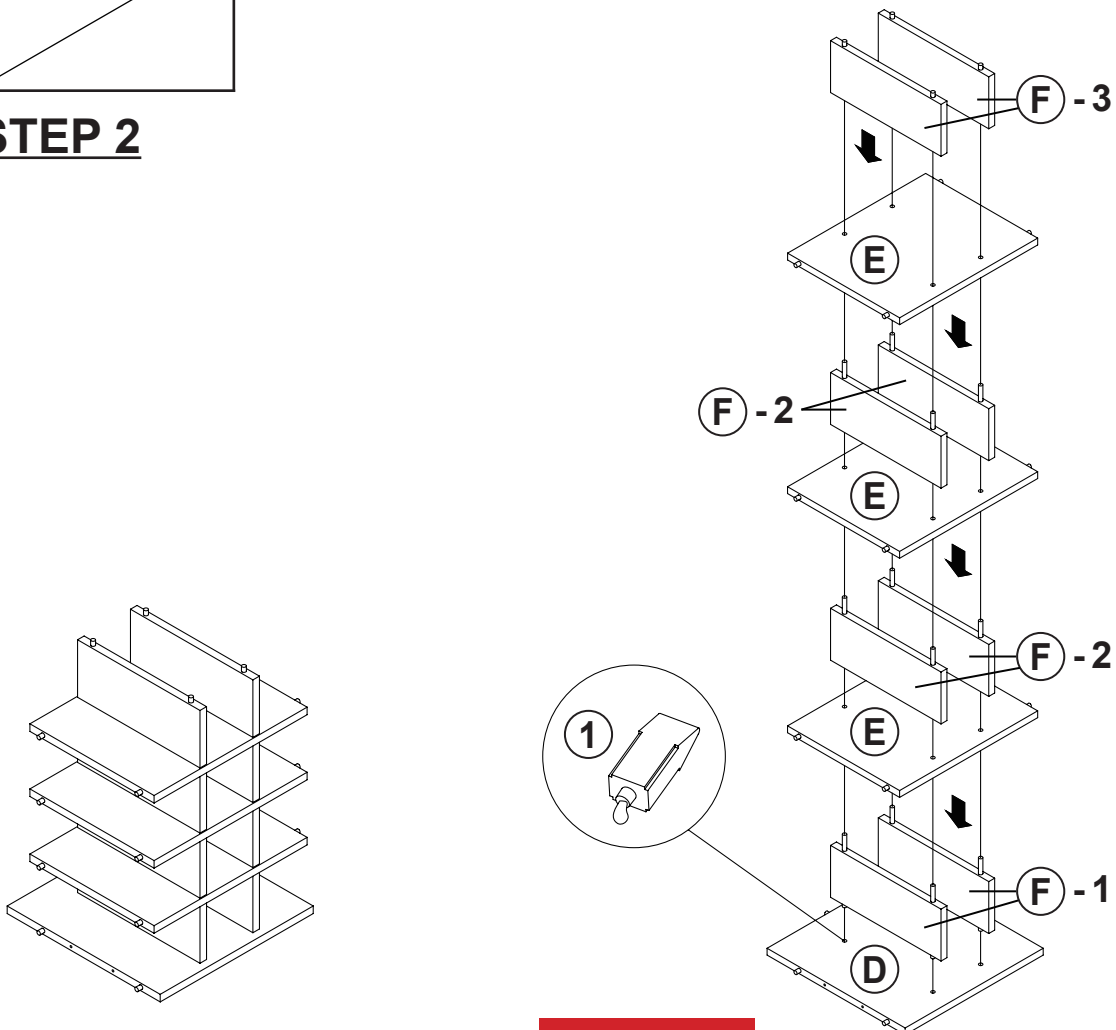

ITEM: 182105

COASTER
FINE FURNITURE

STEP 3

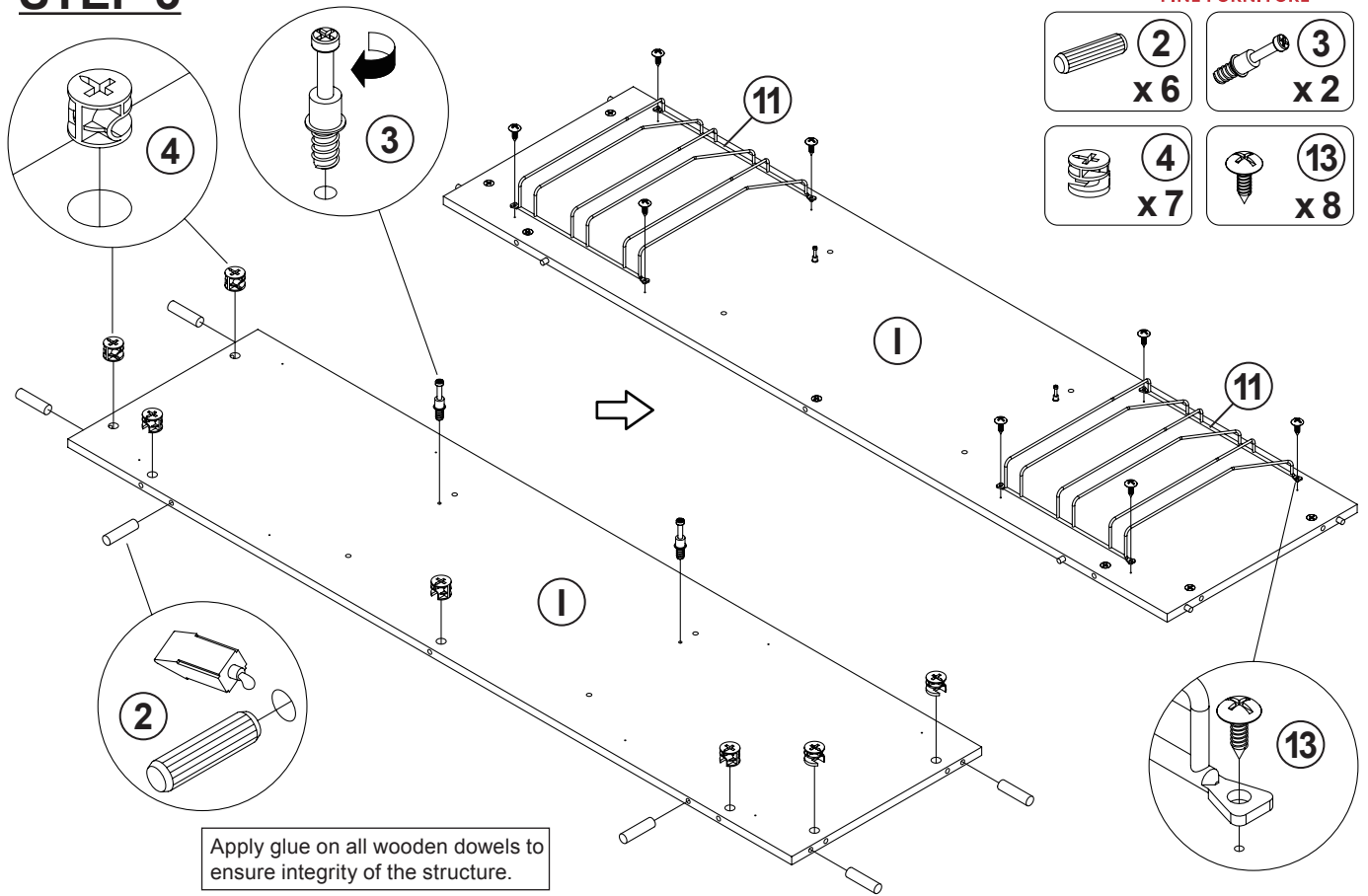

STEP 4

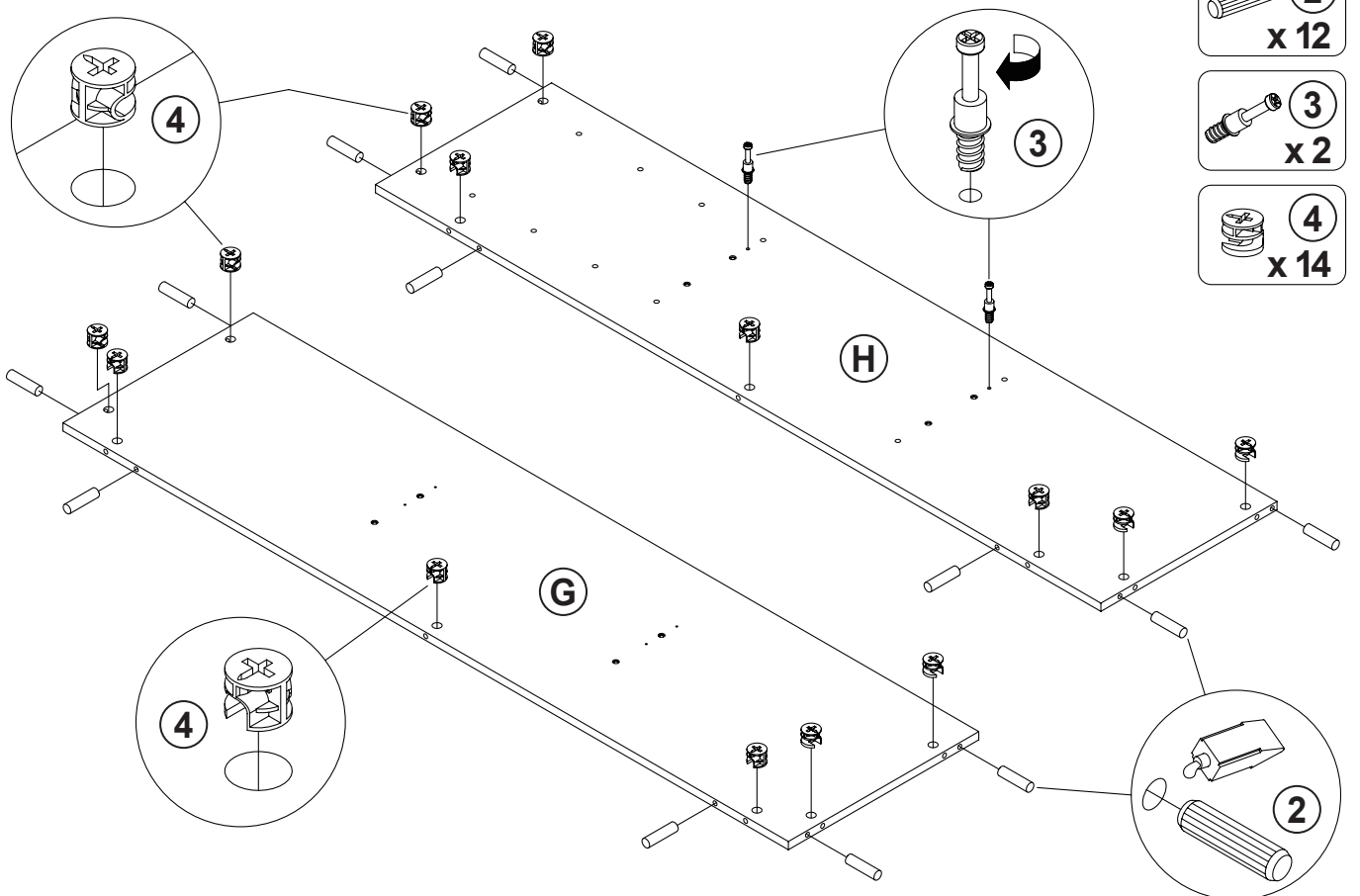

ITEM: 182105

COASTER
FINE FURNITURE

STEP 5

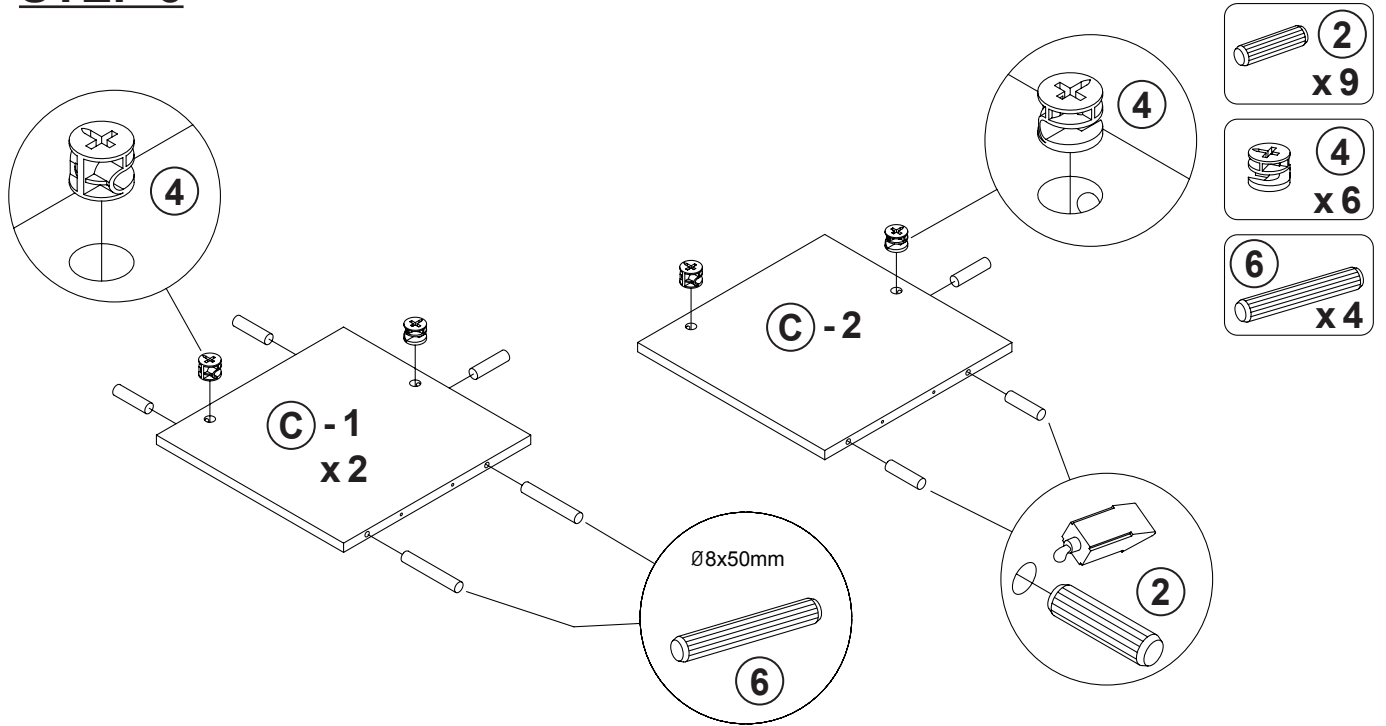

STEP 6

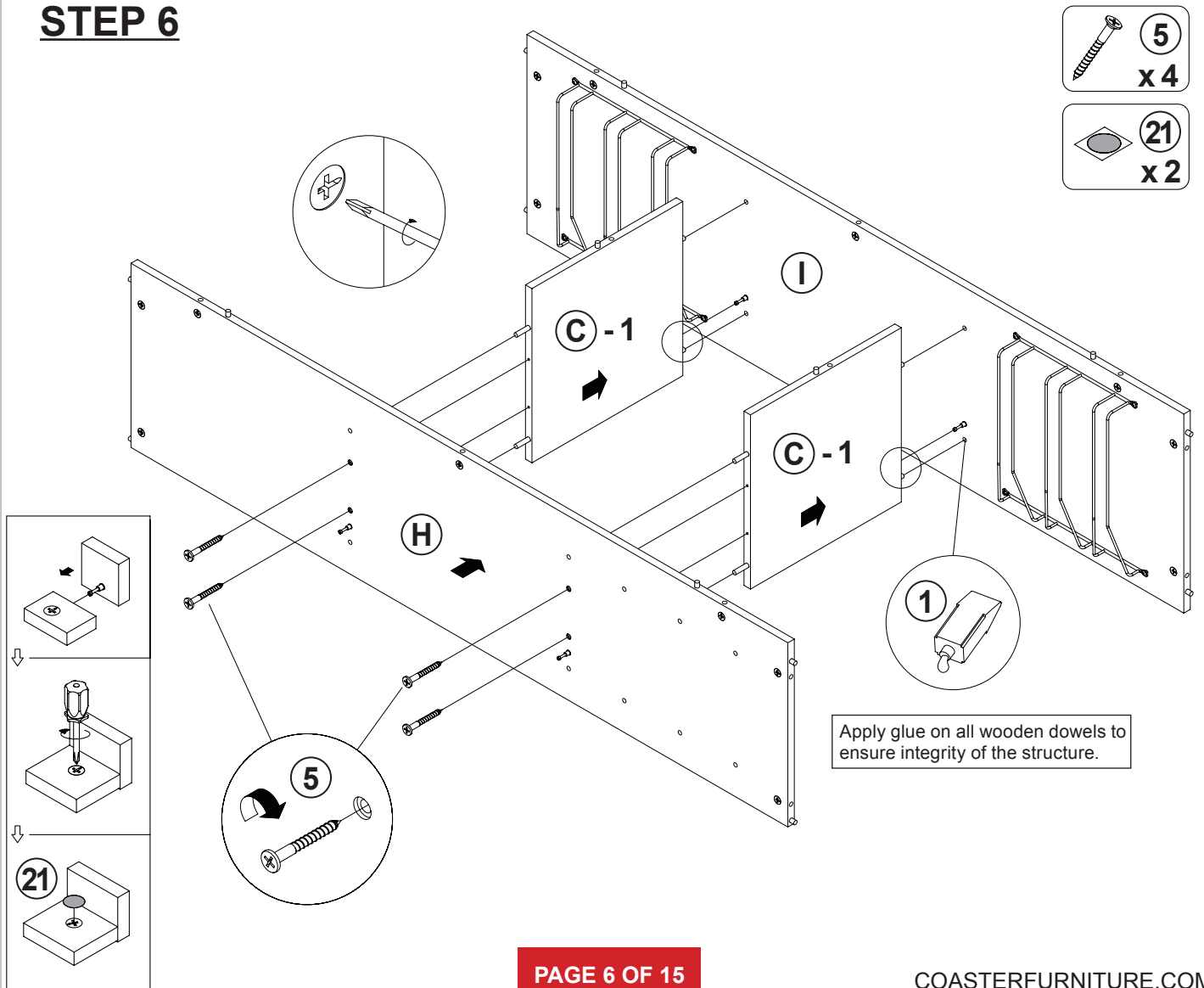

ITEM: 182105

COASTER
FINE FURNITURE

STEP 7

5
x 4

21
x 2

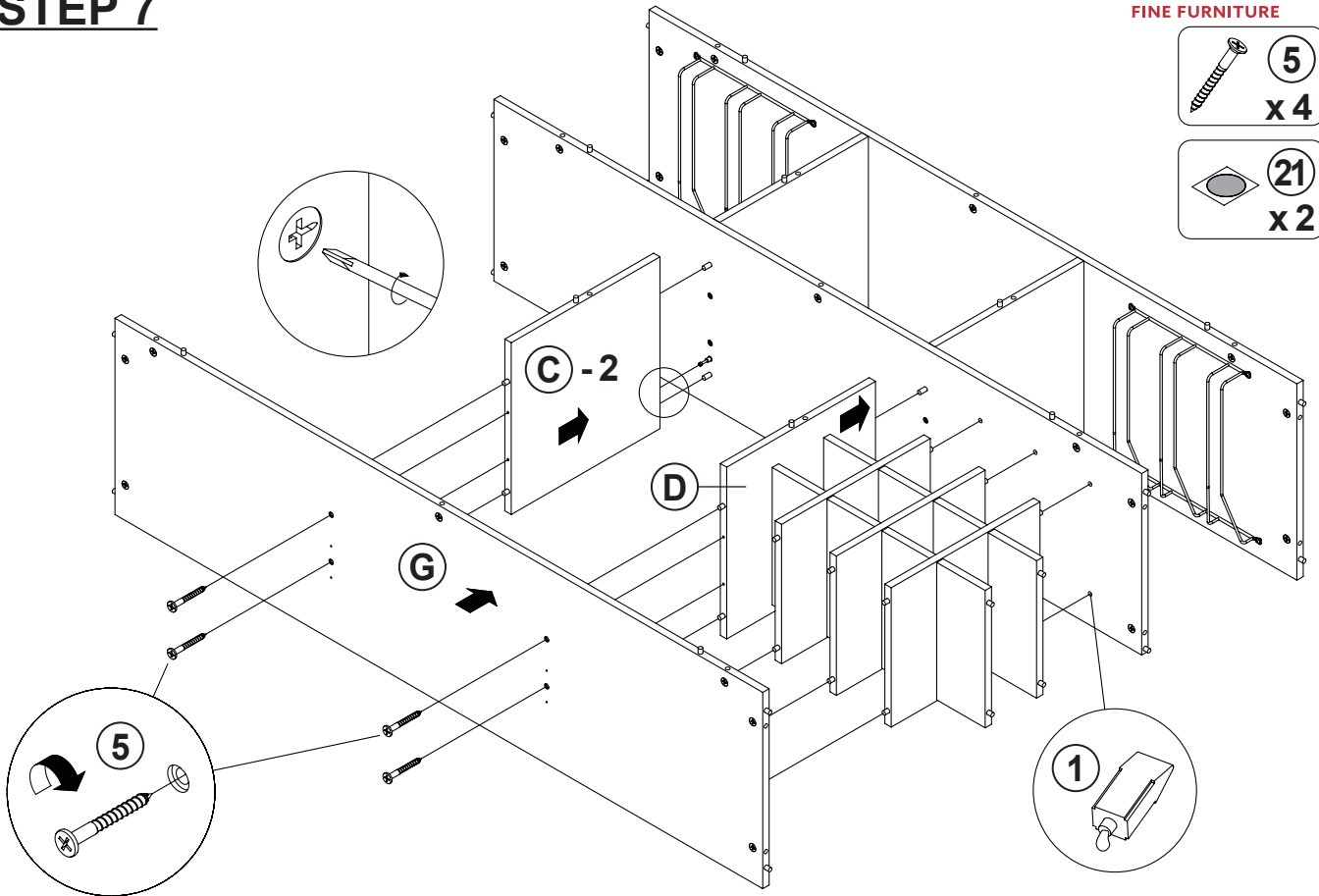

STEP 8

2
x 2

3
x 8

4
x 9

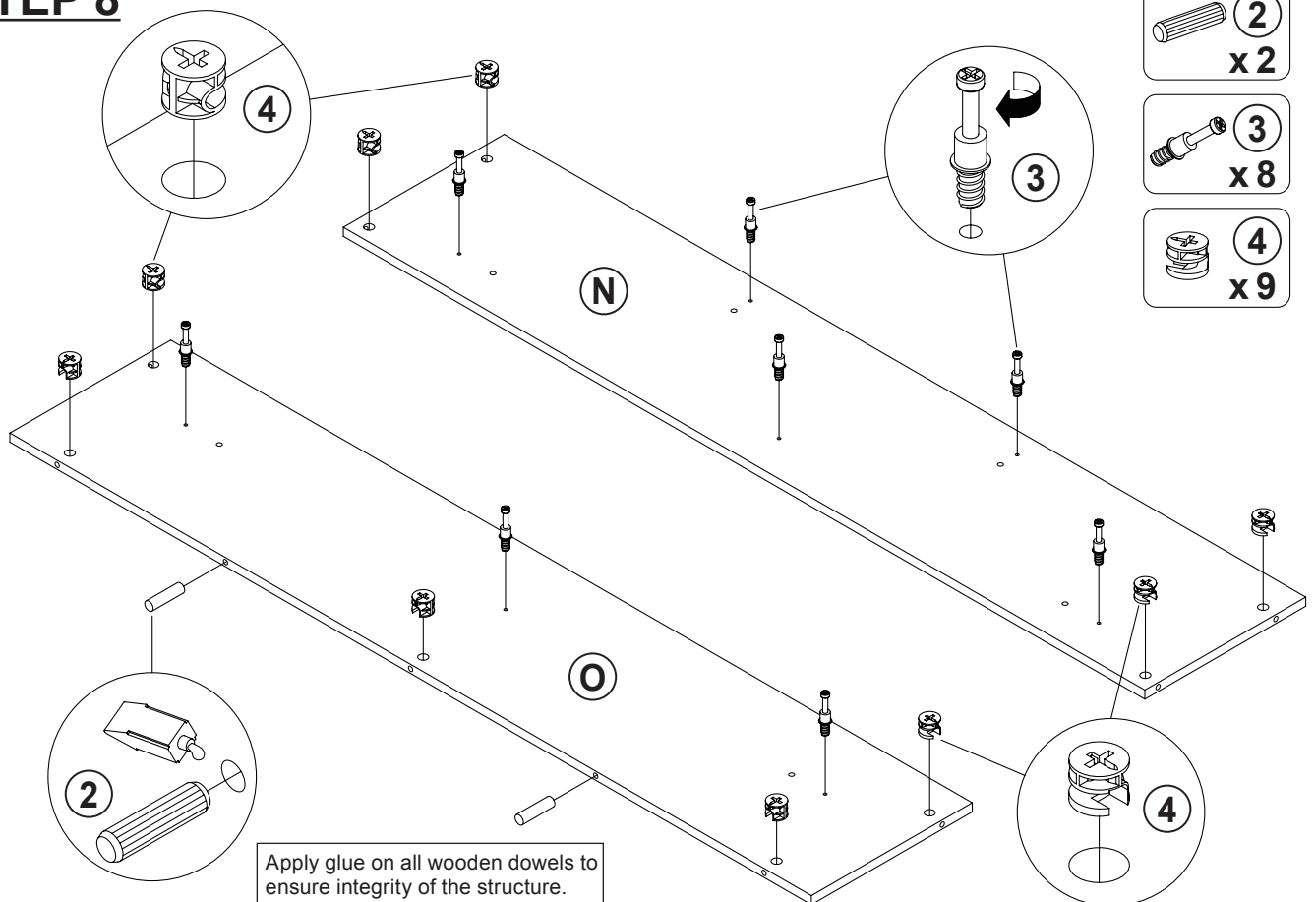

Apply glue on all wooden dowels to ensure integrity of the structure.

ITEM: **182105**

COASTER
FINE FURNITURE

STEP 9

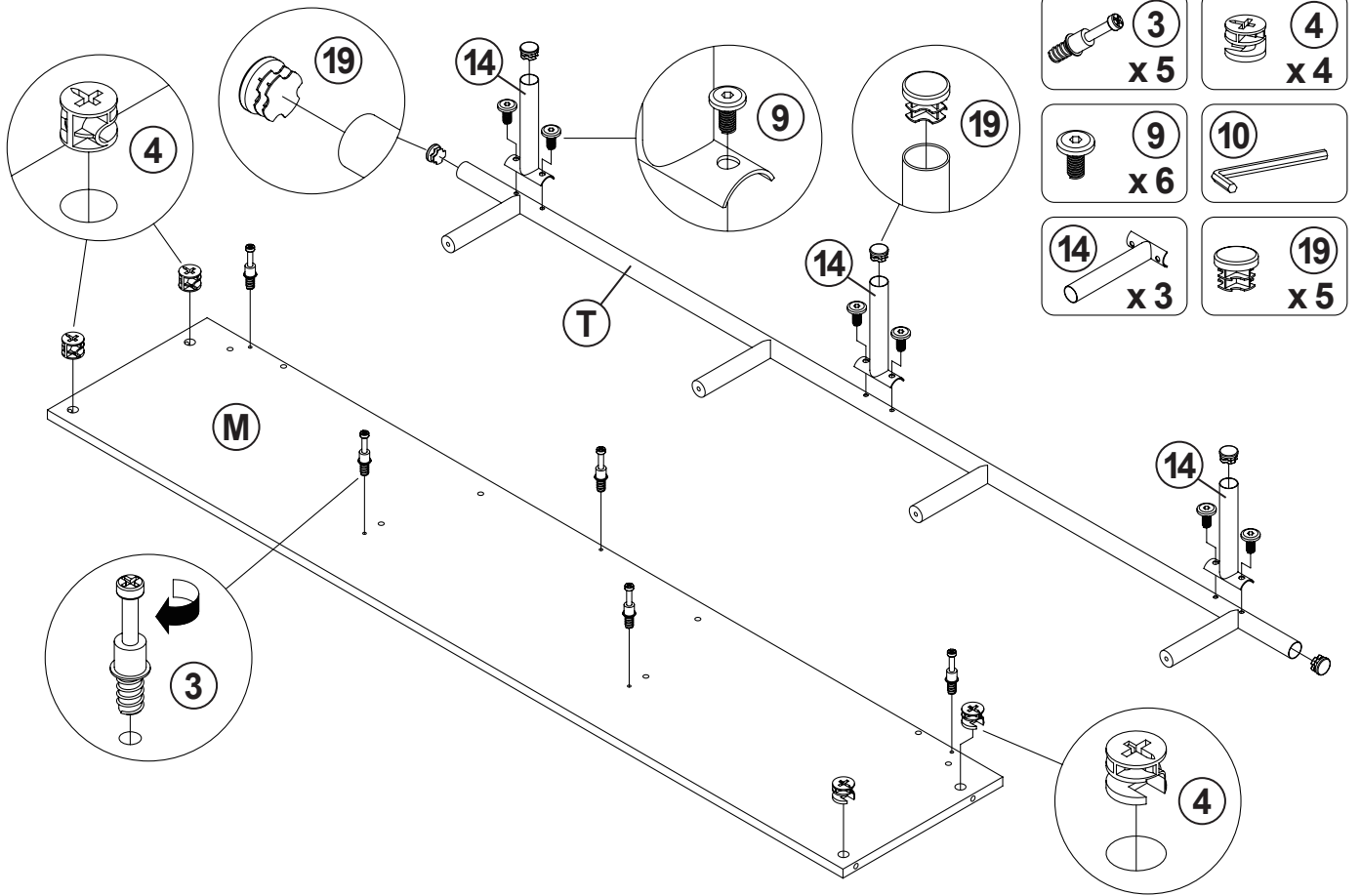

STEP 10

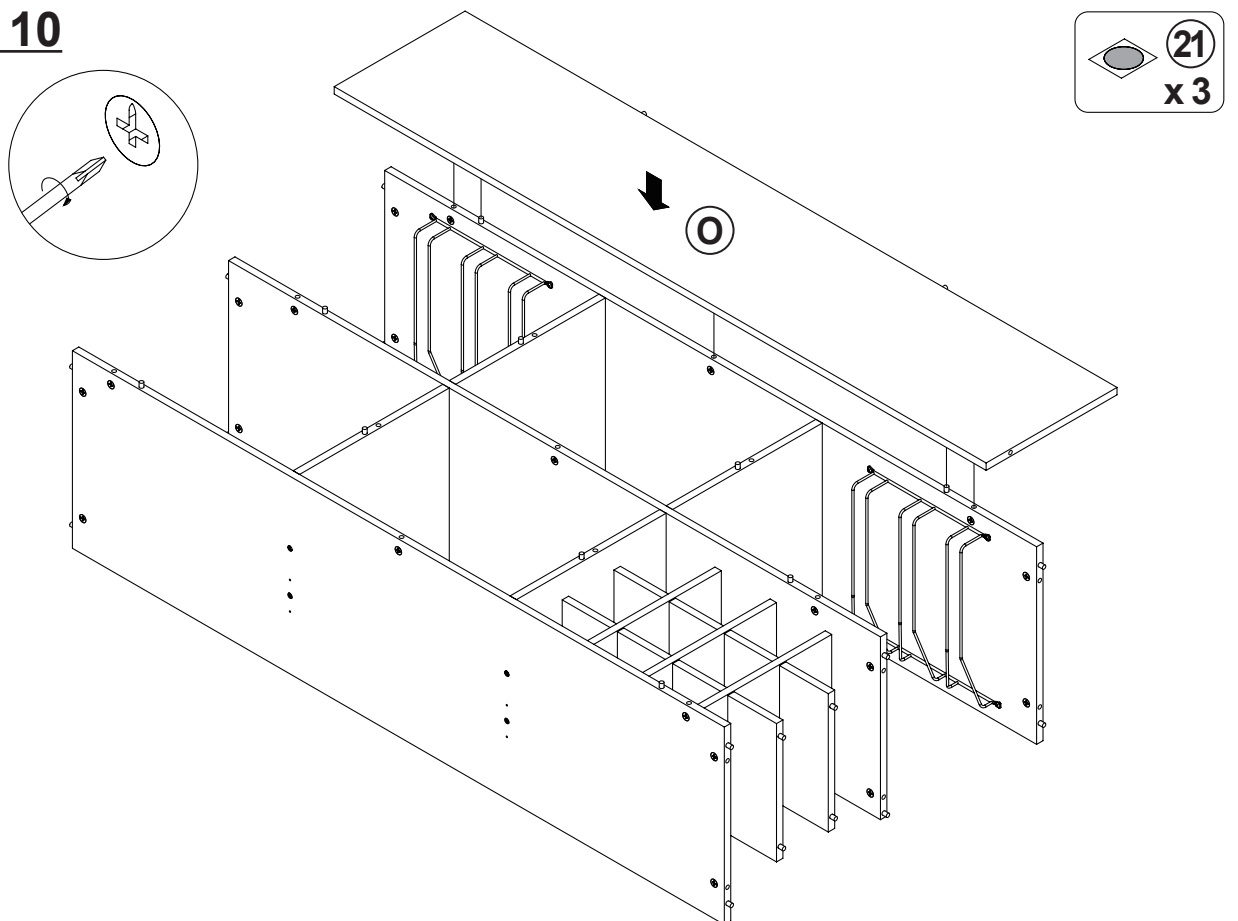

ITEM: **182105**

STEP 11

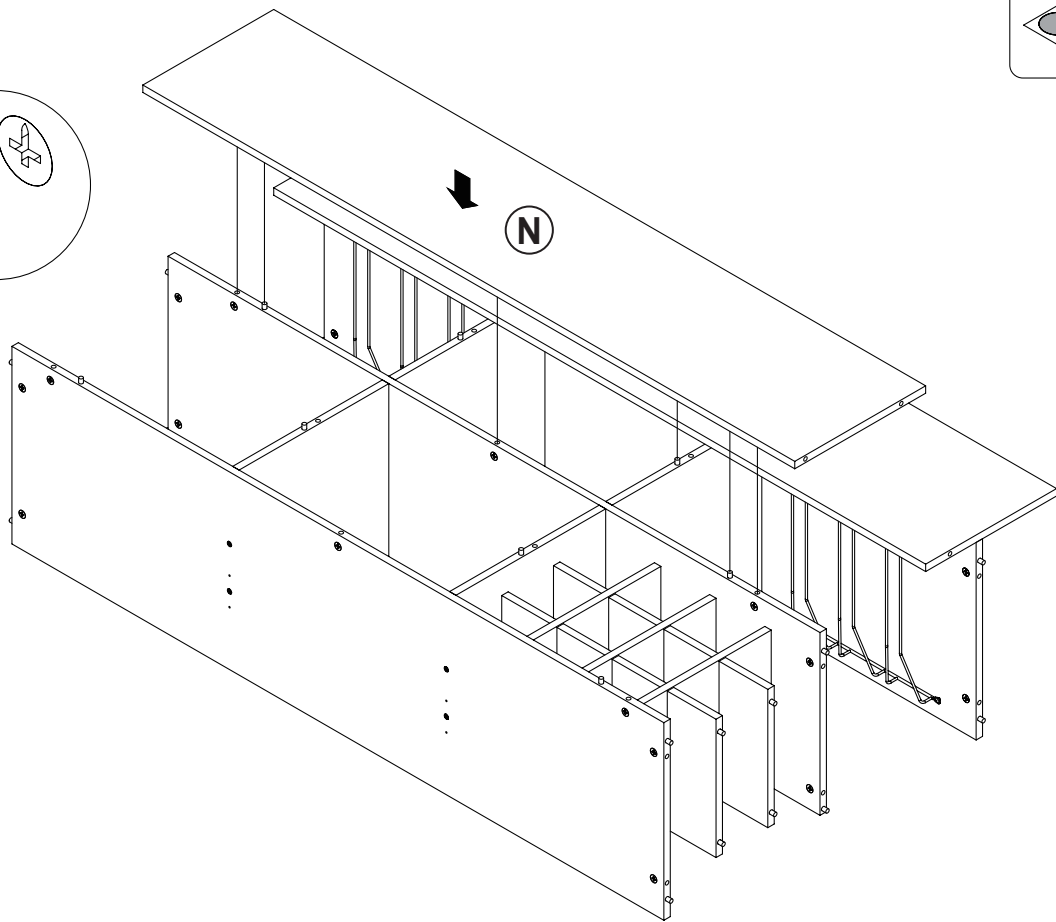
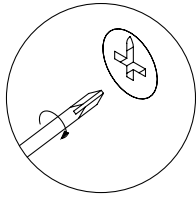
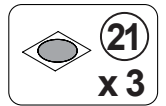

STEP 12

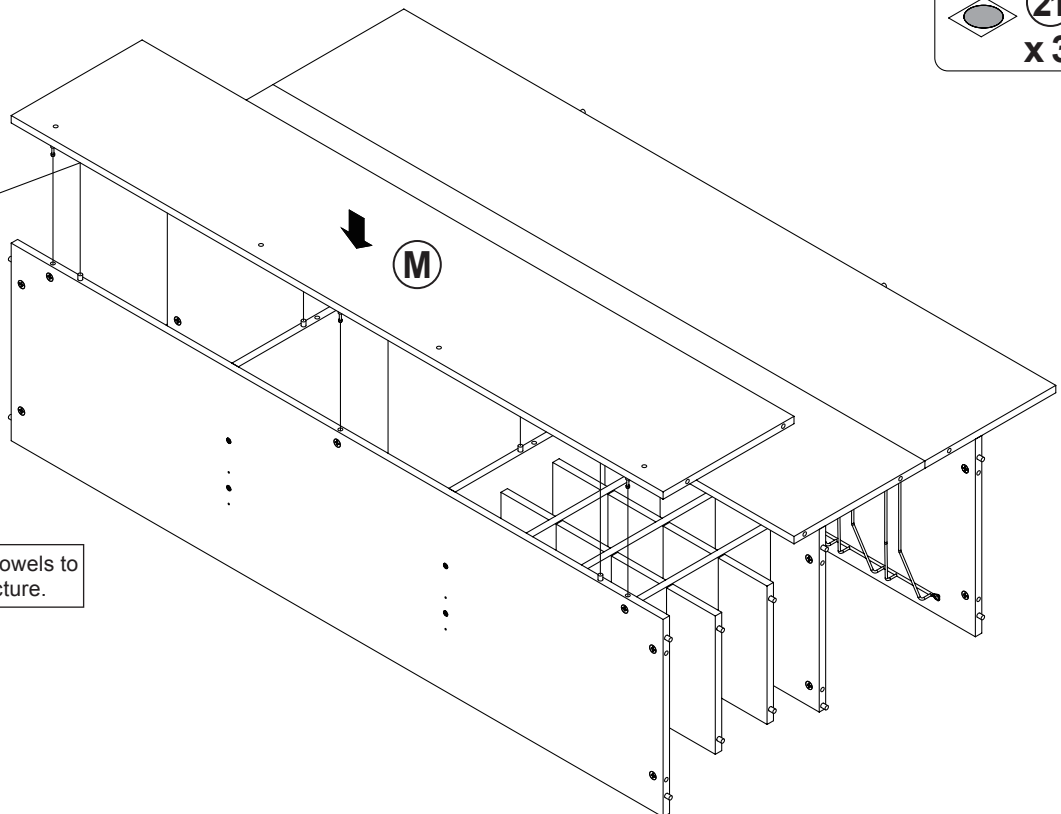
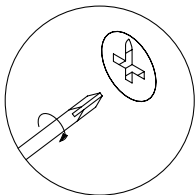
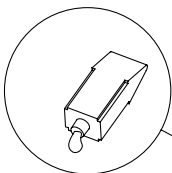
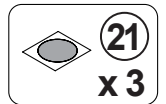

Apply glue on all wooden dowels to ensure integrity of the structure.

ITEM: **182105**

STEP 13

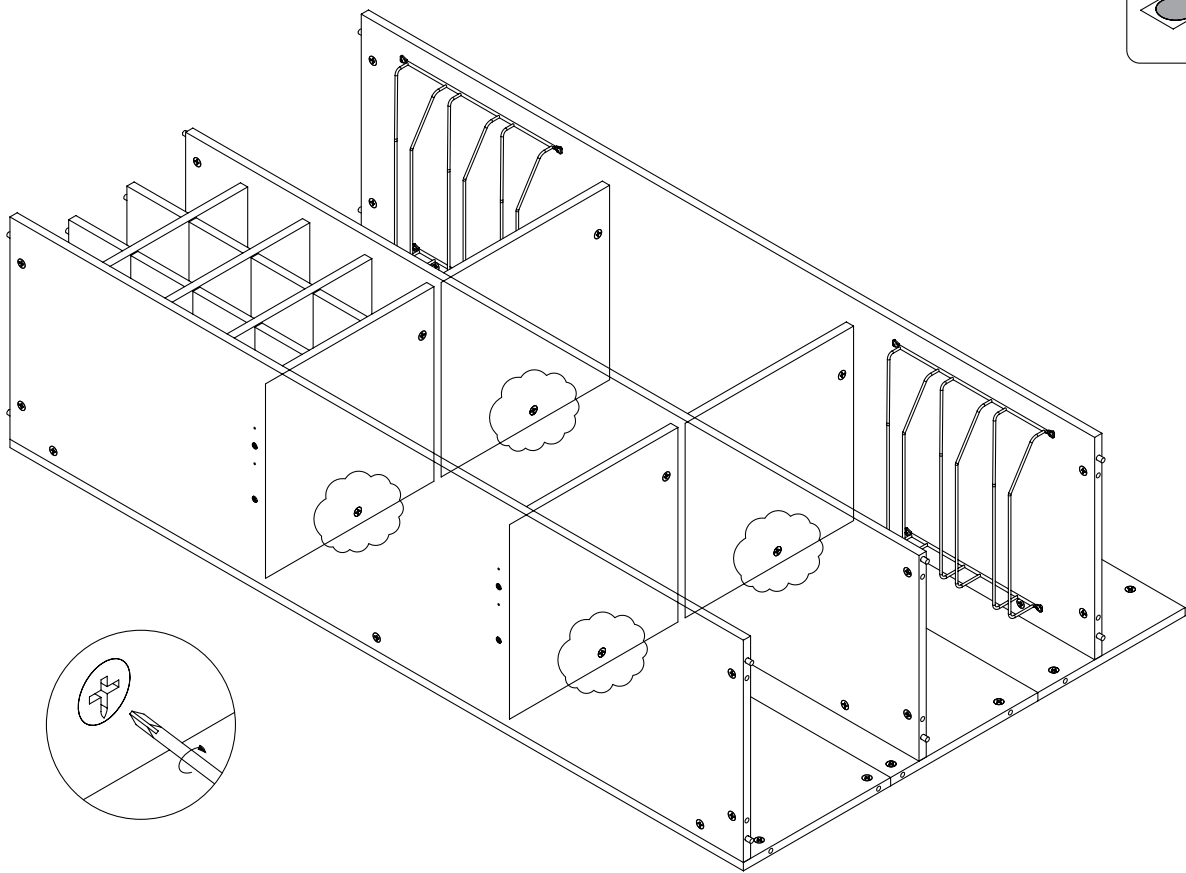
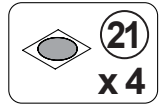

STEP 14

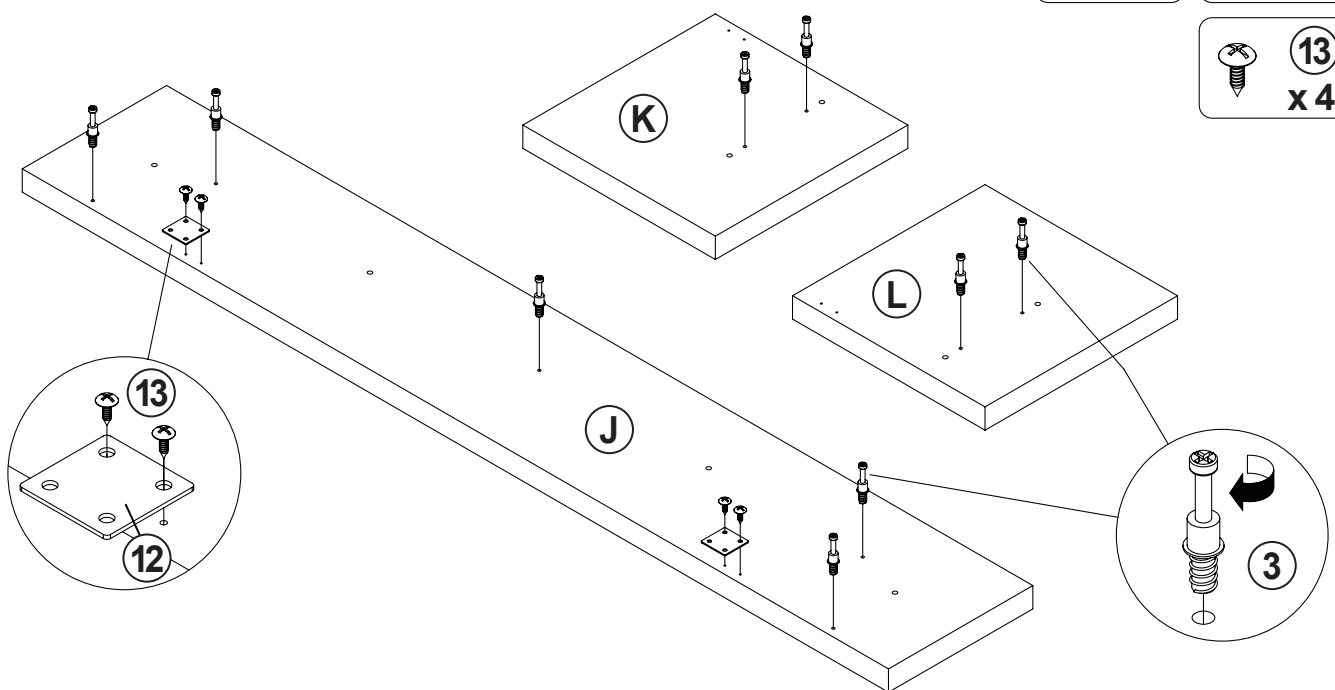
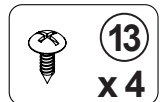
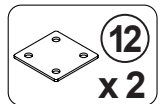
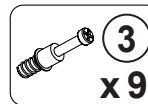

ITEM: 182105

COASTER
FINE FURNITURE

STEP 15

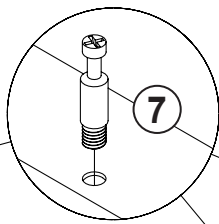
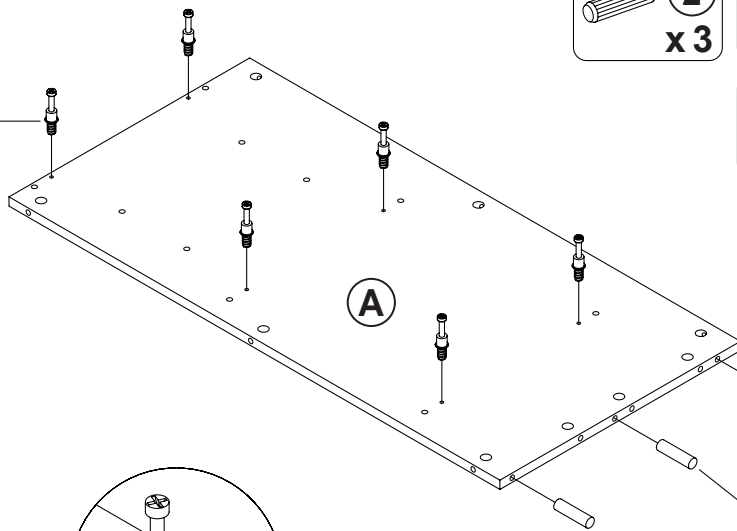
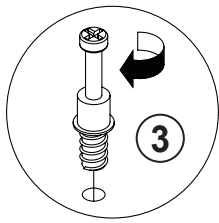
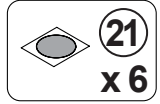
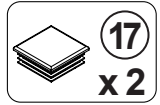
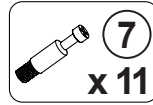
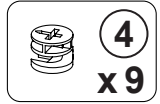
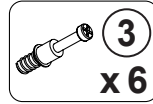
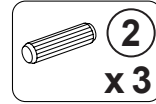

Apply glue on all wooden dowels to ensure integrity of the structure.

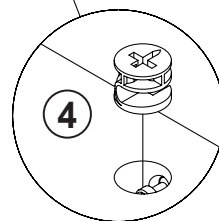
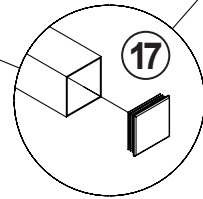
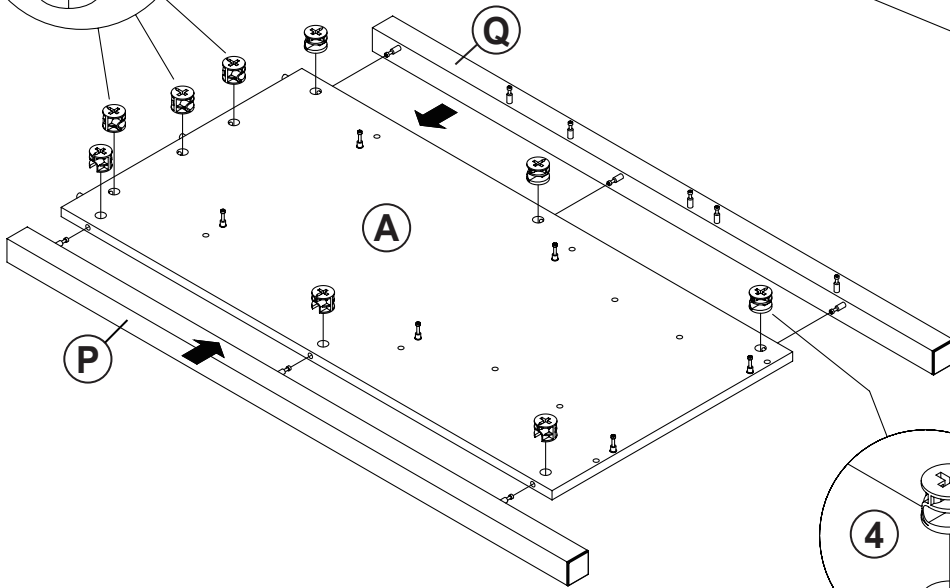
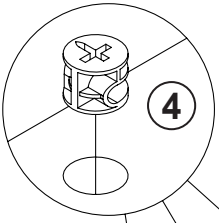
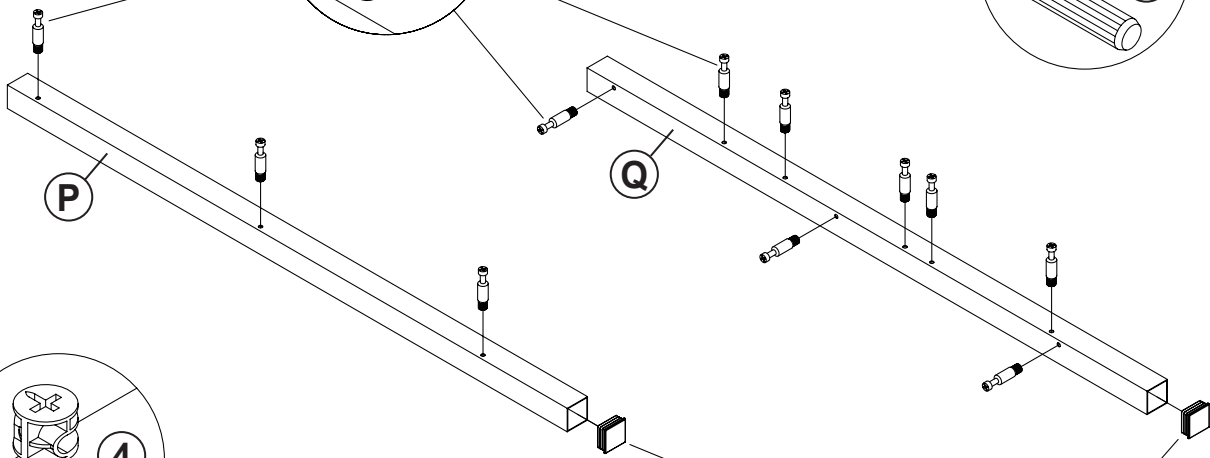
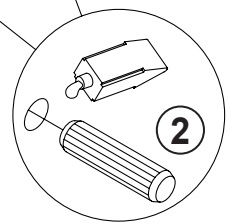

ITEM: 182105

COASTER
FINE FURNITURE

STEP 16

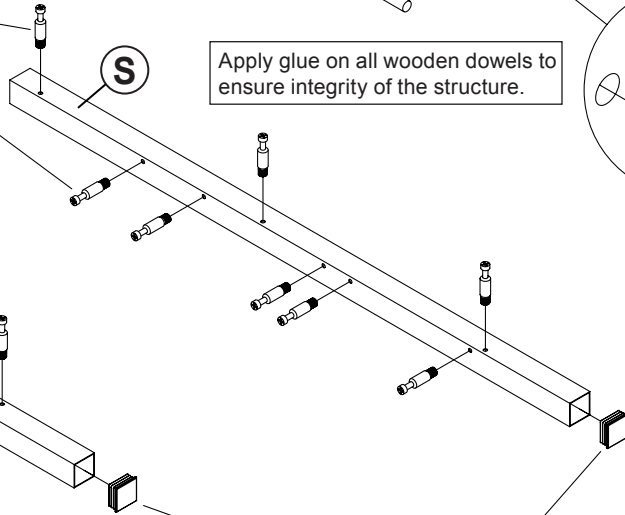
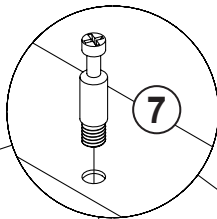
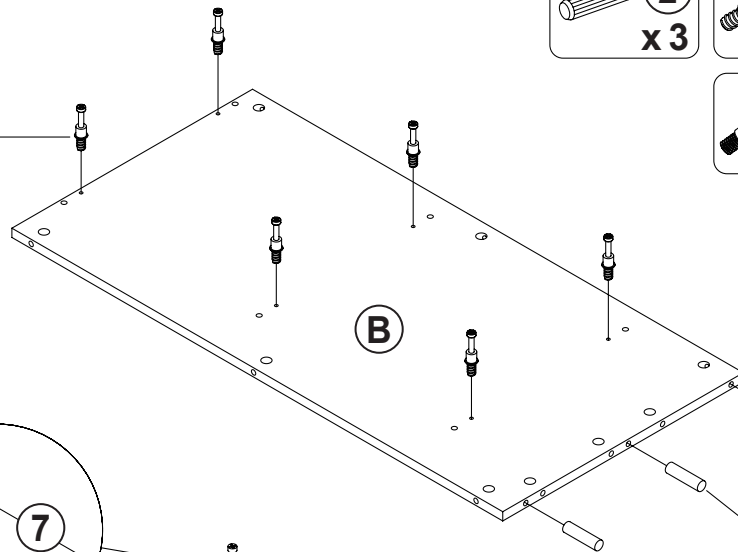
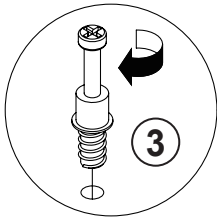
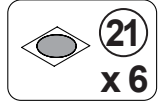
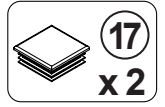
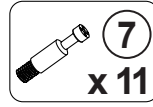
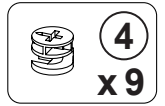
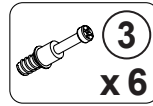
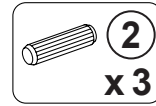

Apply glue on all wooden dowels to ensure integrity of the structure.

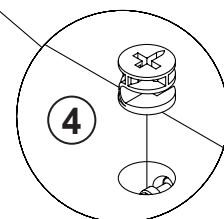
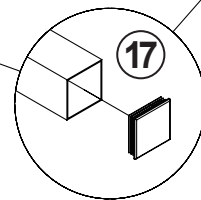
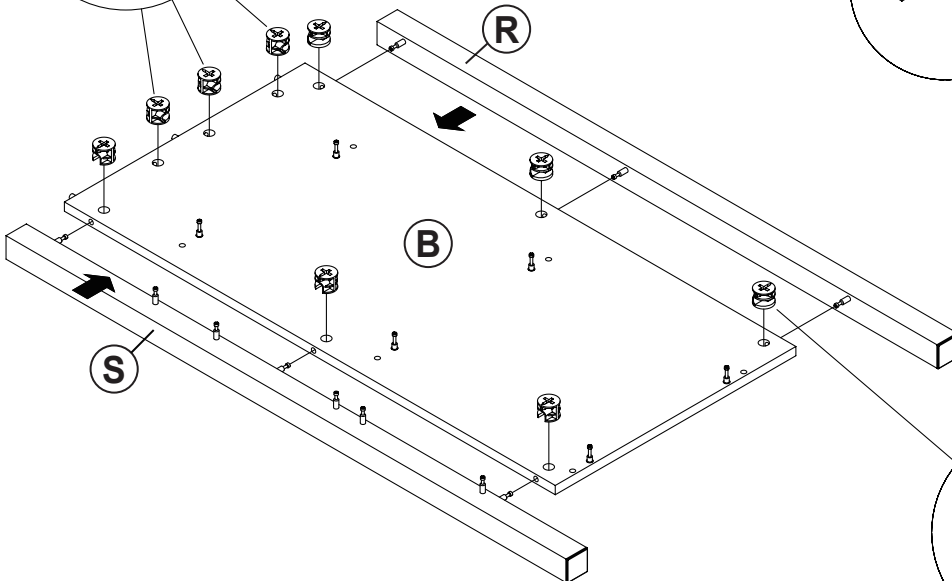
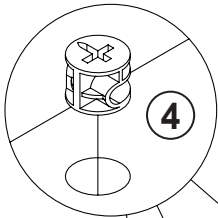
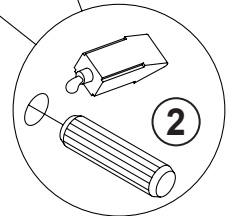

ITEM: 182105

COASTER
FINE FURNITURE

STEP 17

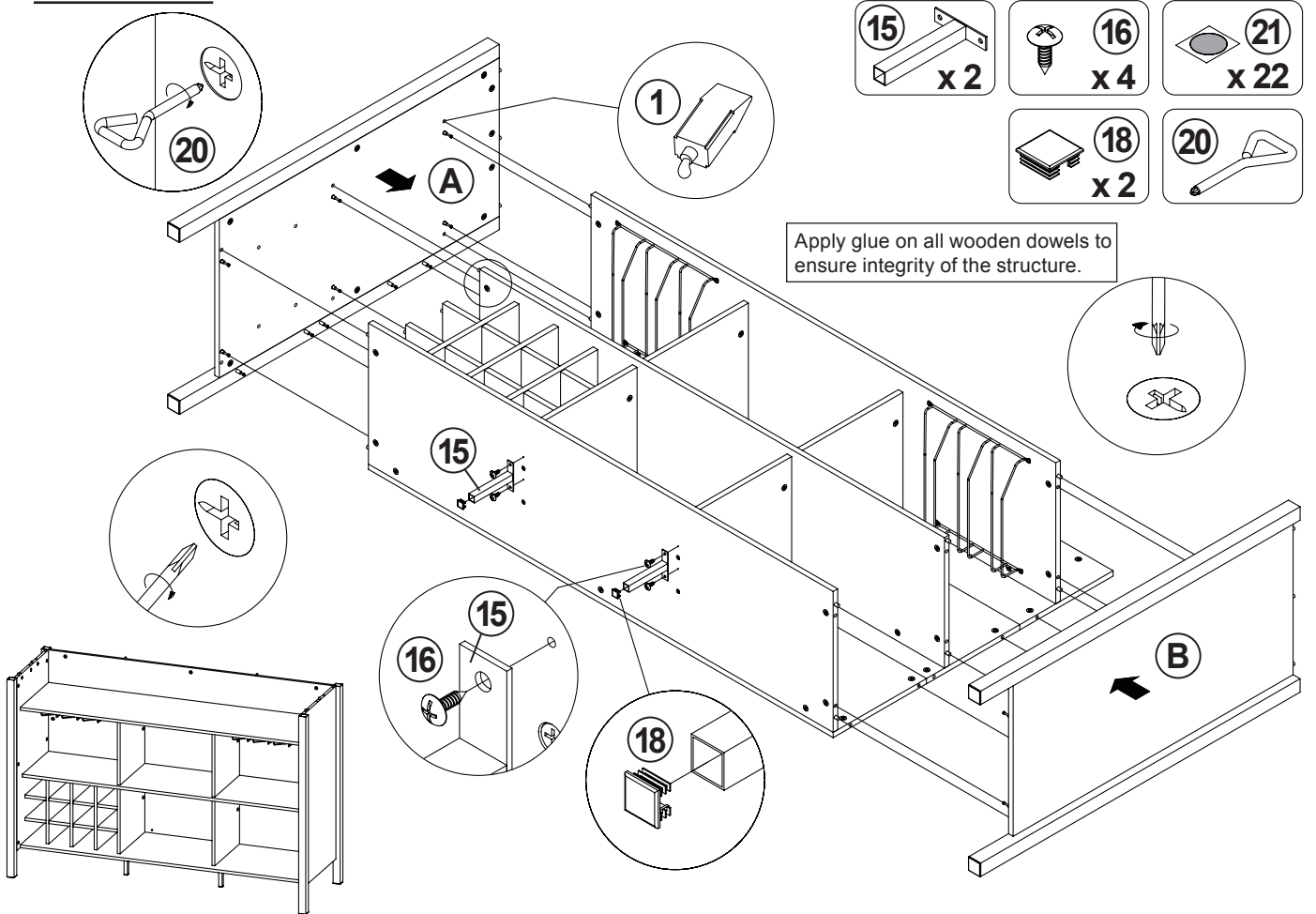

STEP 18



ITEM: **182105**

STEP 19

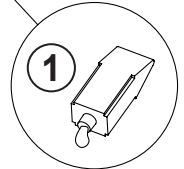
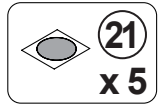
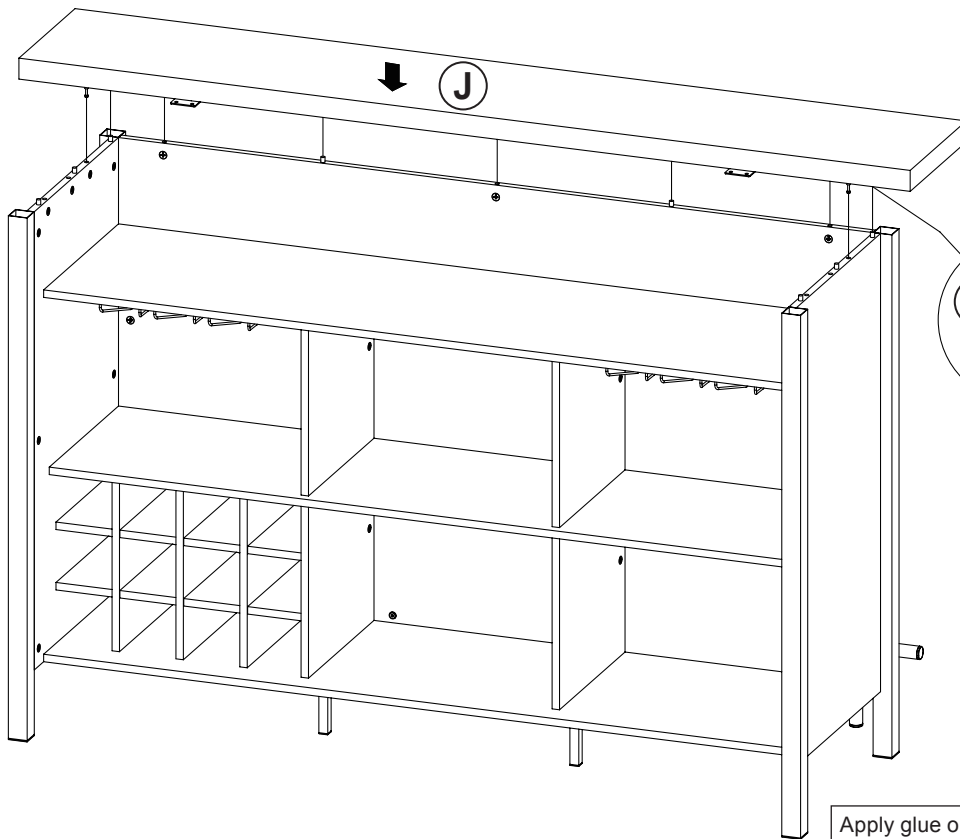
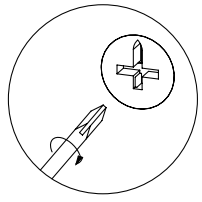

Apply glue on all wooden dowels to ensure integrity of the structure.

STEP 20

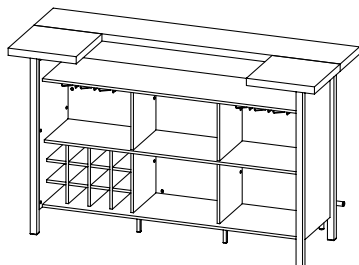
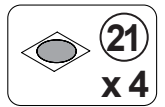
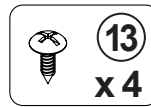
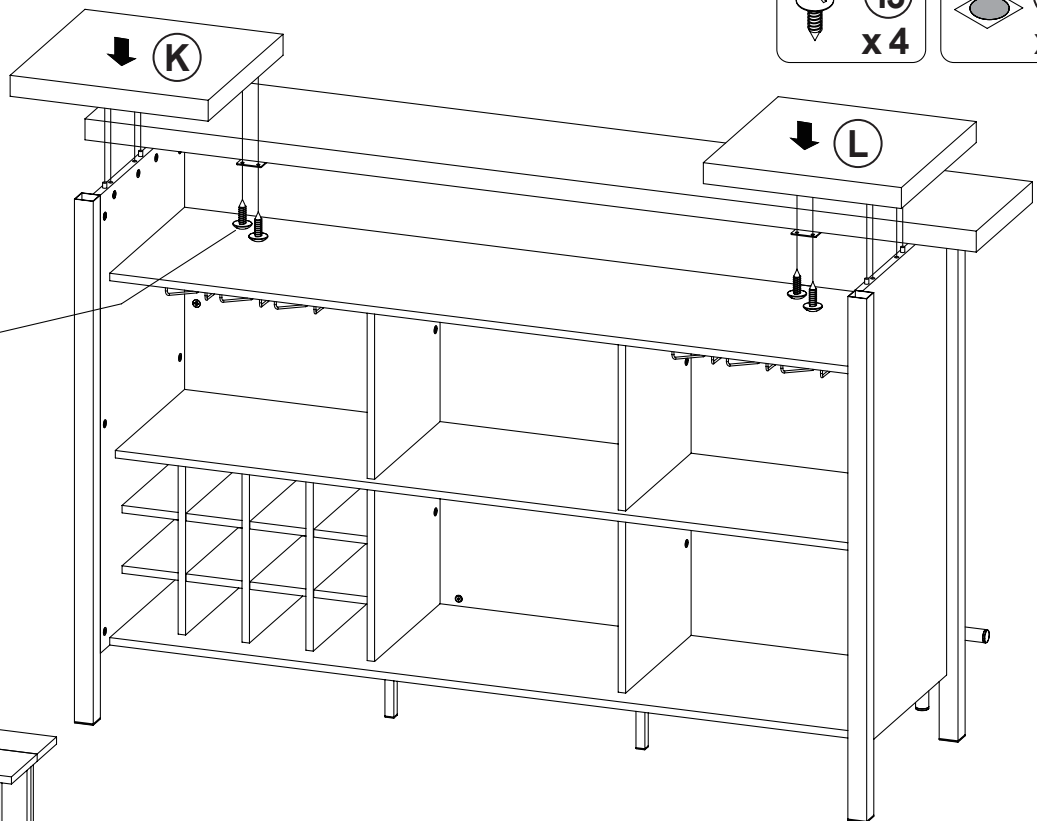
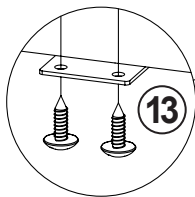
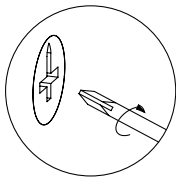

ITEM: 182105

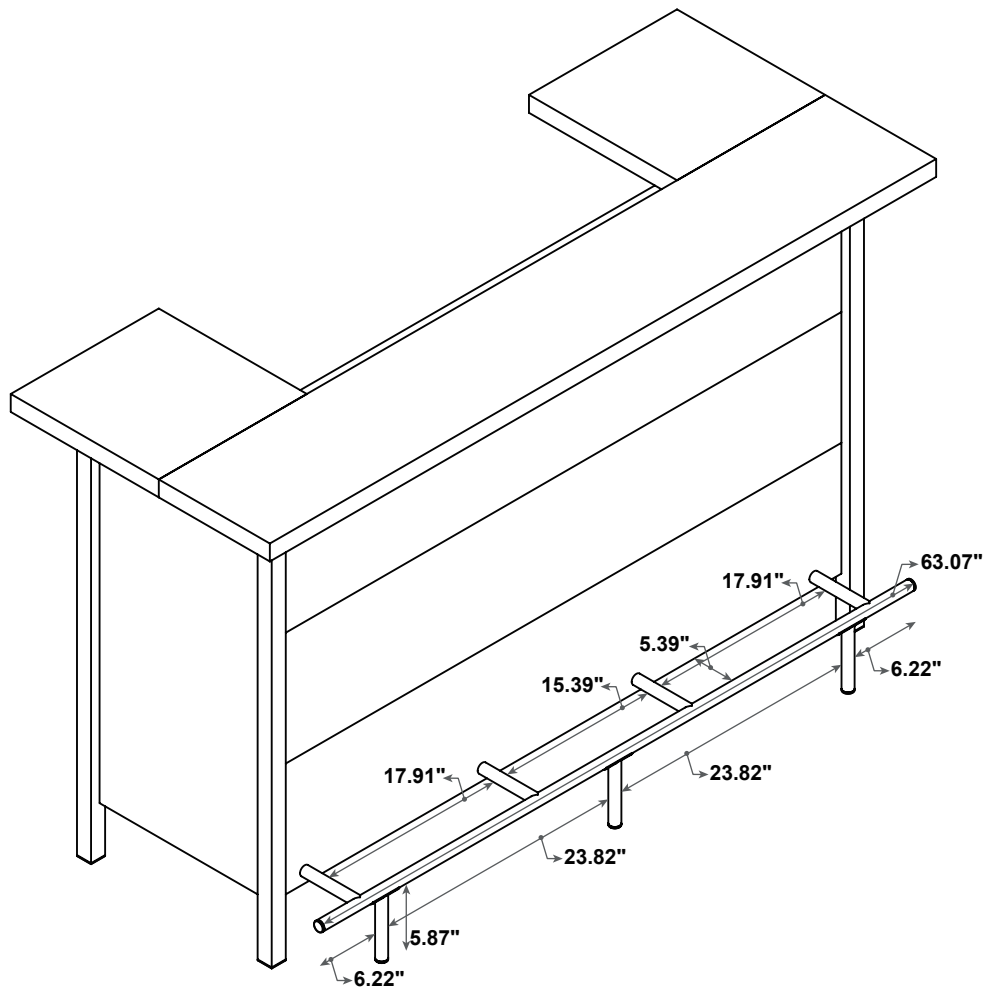
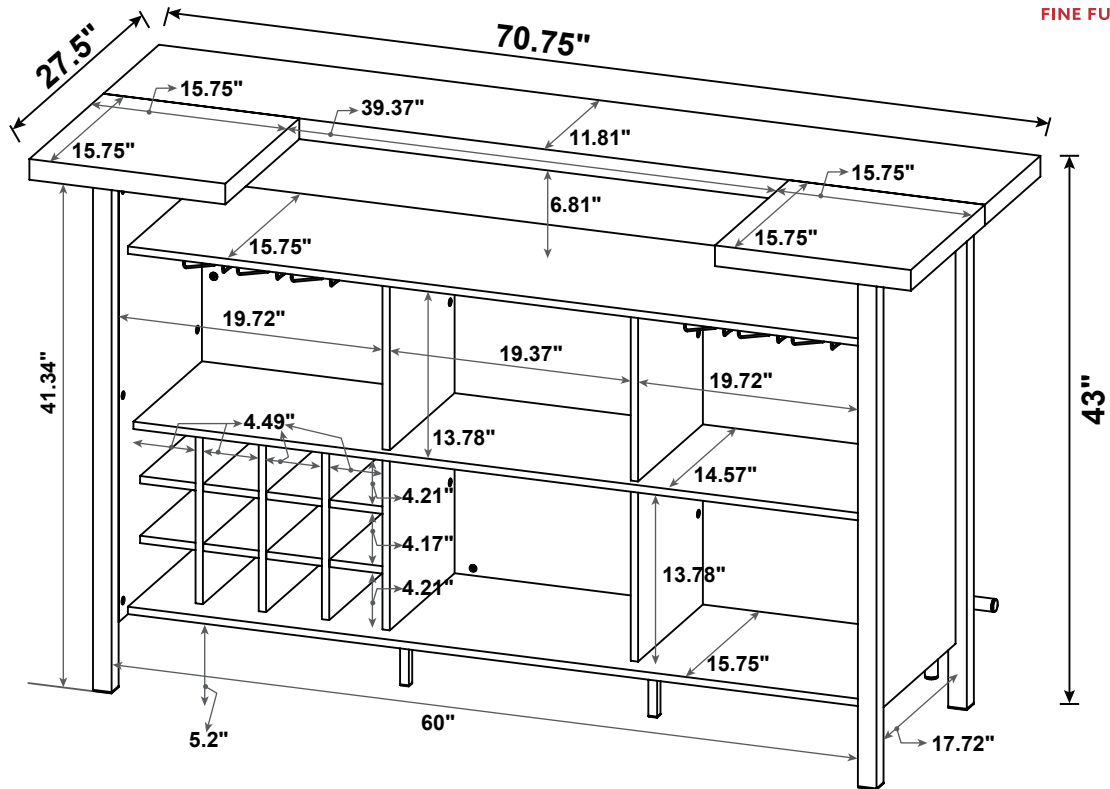

Note : Dimension tolerance $\pm 5\%$