

**ASSEMBLY INSTRUCTIONS**  
**COASTER FINE FURNITURE**



*Fine Furniture for every stage of life*

**900932**

**HALL TREE**

**ITEM:900932**

# ASSEMBLY INSTRUCTIONS



**ASSEMBLY TIPS:**

- 1. Remove hardware from box and sort by size.
- 2. Please check to see that all hardware and parts are present prior to start of assembly.
- 3. Please follow attached instructions in the same sequence as numbered to assure fast & easy assembly.



**WARNING!**



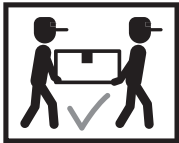



- 1. Don't attempt to repair or modify parts that are broken or defective. Please contact the store immediately.
- 2. This product is for home use only and not intended for commercial establishments.



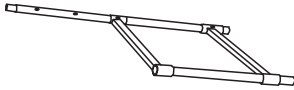
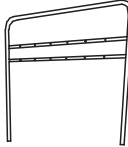

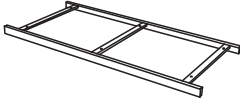



ASSEMBLY TIME

30 MINUTES

## PARTS IDENTIFICATION

A	LEGS		2PCS
B	TOP FRAME		1PC
C	BACK FRAME		1PC
D	LEG FRAME		2PCS
E	HANGERS		6PCS
F	CUSHION		1PC
G	BOTTOM SHELF		1PC

## Z HARDWARE IDENTIFICATION

	DESCRIPTION	FIGURE	Q'TY
1	SHORT BOLT (M6X12MM)		4PCS
2	MEDIUM BOLT (M6X25MM)		12PCS
3	LARGE BOLT (M6X40MM)		4PCS
4	EXTRA LARGE BOLT (M6X50MM)		8PCS
5	SCREW (4X25MM)		12PCS
6	PLASTIC CAP		4PCS
7	ALLEN WRENCH (M4)		1PC

ITEM:900932

**ASSEMBLY INSTRUCTIONS**

**STEP 1**

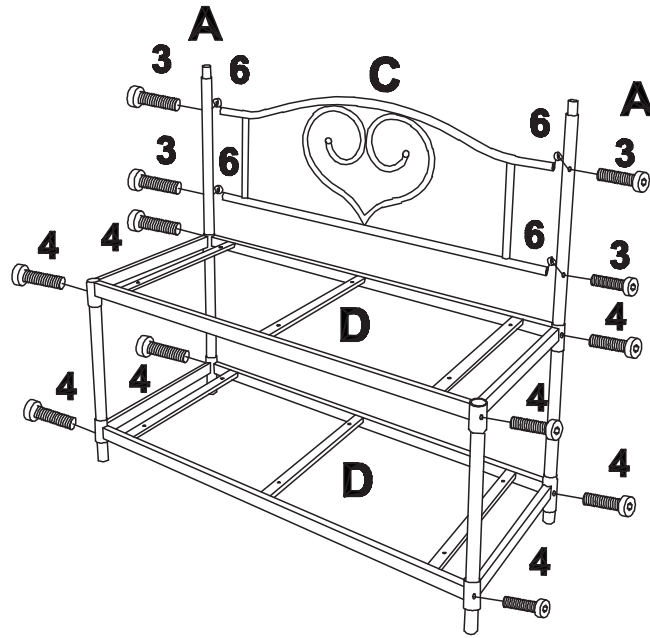

**STEP 2**

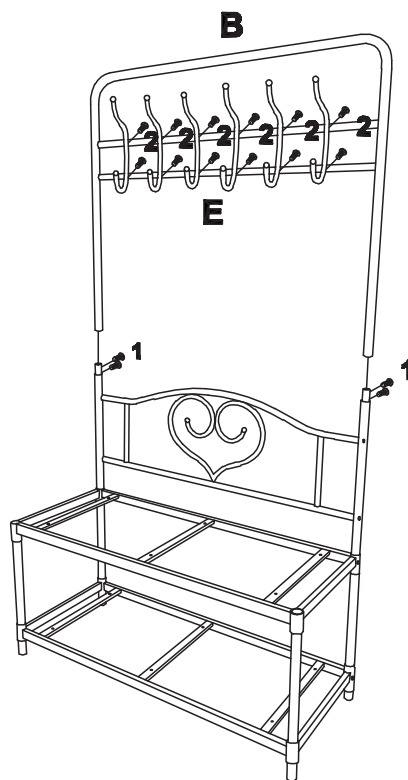

ITEM:900932

**ASSEMBLY INSTRUCTIONS**

**STEP 3**

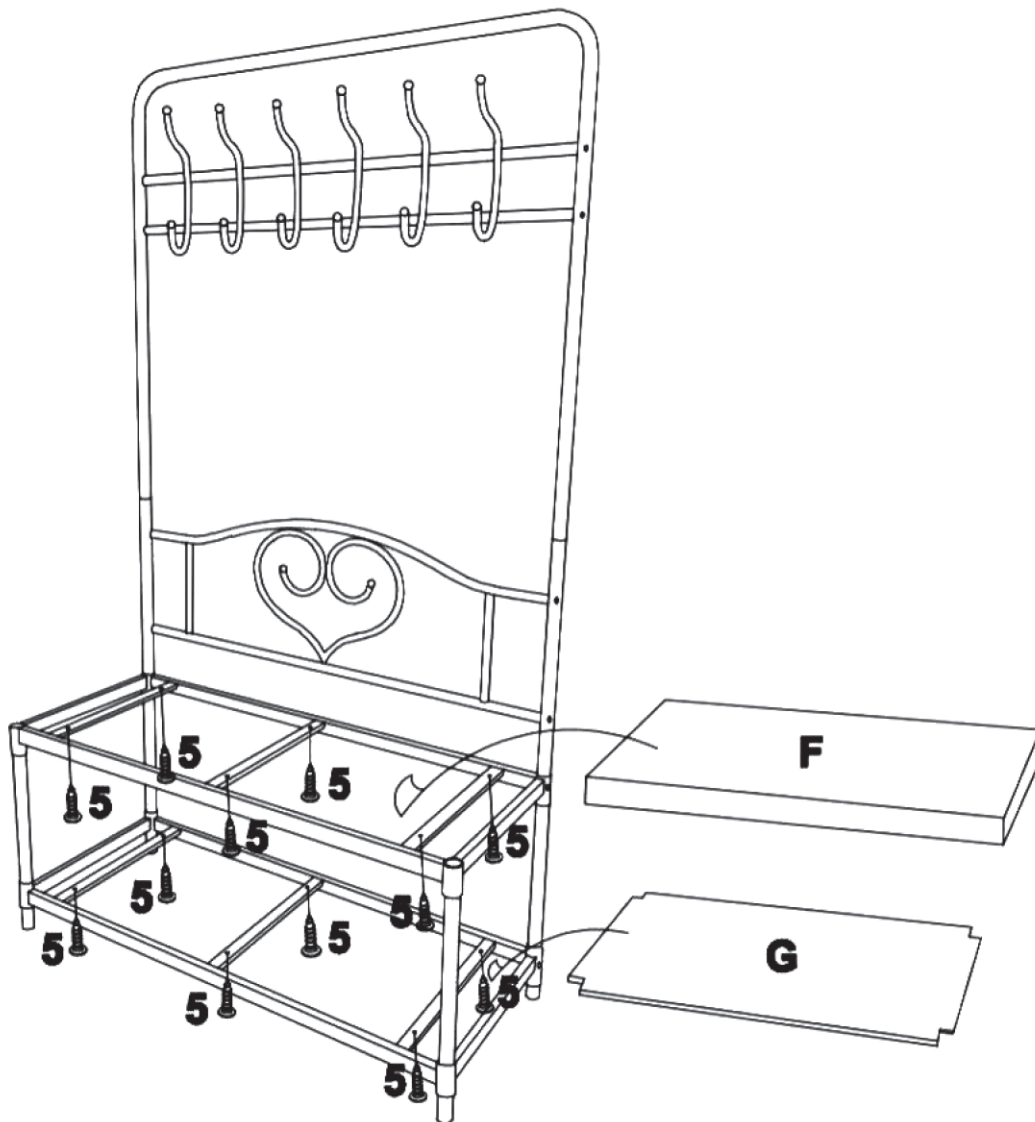

ITEM:900932

