

**ASSEMBLY INSTRUCTIONS**  
**COASTER FINE FURNITURE**



*Fine Furniture for every stage of life*

952845

*Accent Cabinet*

ITEM: **952845**

# ASSEMBLY INSTRUCTION



## ASSEMBLY TIPS:

1. Remove hardware from box and sort by size.
2. Please check to see that all hardware and parts are present prior to start of assembly.
3. Please follow attached instructions in the same sequence as numbered to assure fast & easy assembly.



Warning!

1. Don't attempt to repair or modify parts that are broken or defective. Please contact the store immediately.
2. This product is for home use only and not intended for commercial establishments.

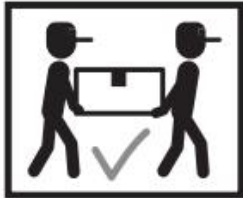

ASSEMBLY TIME PER UNIT

5 MINUTES

## PARTS IDENTIFICATION

**A** CABINET



1 PC

**B** LEG



5 PCS

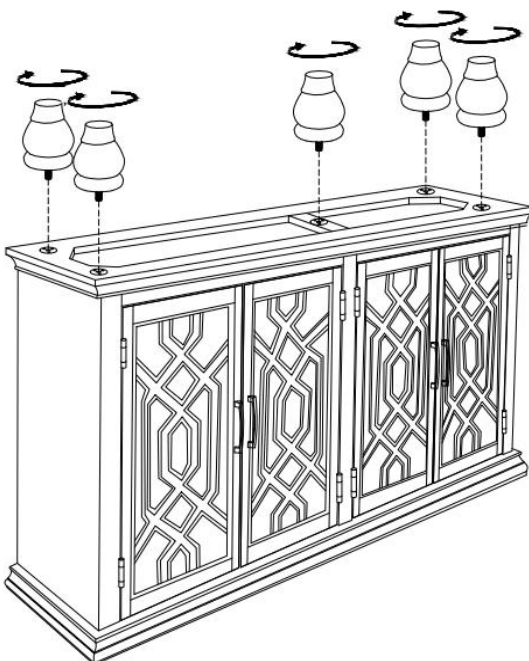

**B**

**A**





ITEM: **952845**



# ASSEMBLY INSTRUCTION

ATTENTION: Anti tipping safeguard  
Please install the Anti tipping hardware  
as shown in the drawing this can help to  
prevent any tipping issues.

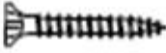
## Z99 HARDWARE IDENTIFICATION

NO.	DESCRIPTION	FIGURE	SIZE	QTY
1	PLUG			2PC
2	LARGE SCREW		Ø8×2"	1PC
3	TIGHTWIRE		280mm	1PC
4	SHORT SCREW		Ø8×3/4"	1PC

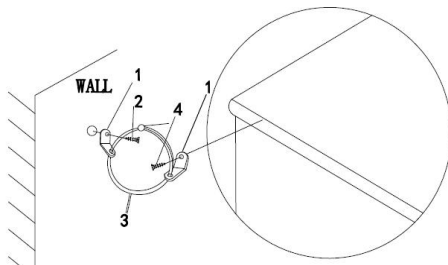

## FURNITURE TIPPING RESTRAINT

### WARNING

Injury may result from tipping furniture.  
This restraint may protection against tipping furniture.  
Do not allow children to climb on furniture.  
This restraint is not a substitute for proper adult supervision.  
Failure to detach this restraint before moving the furniture may  
result in injury and damage.

ITEM: **952845**

# ASSEMBLY INSTRUCTION



PRODUCT/PART DIMENSIONS:

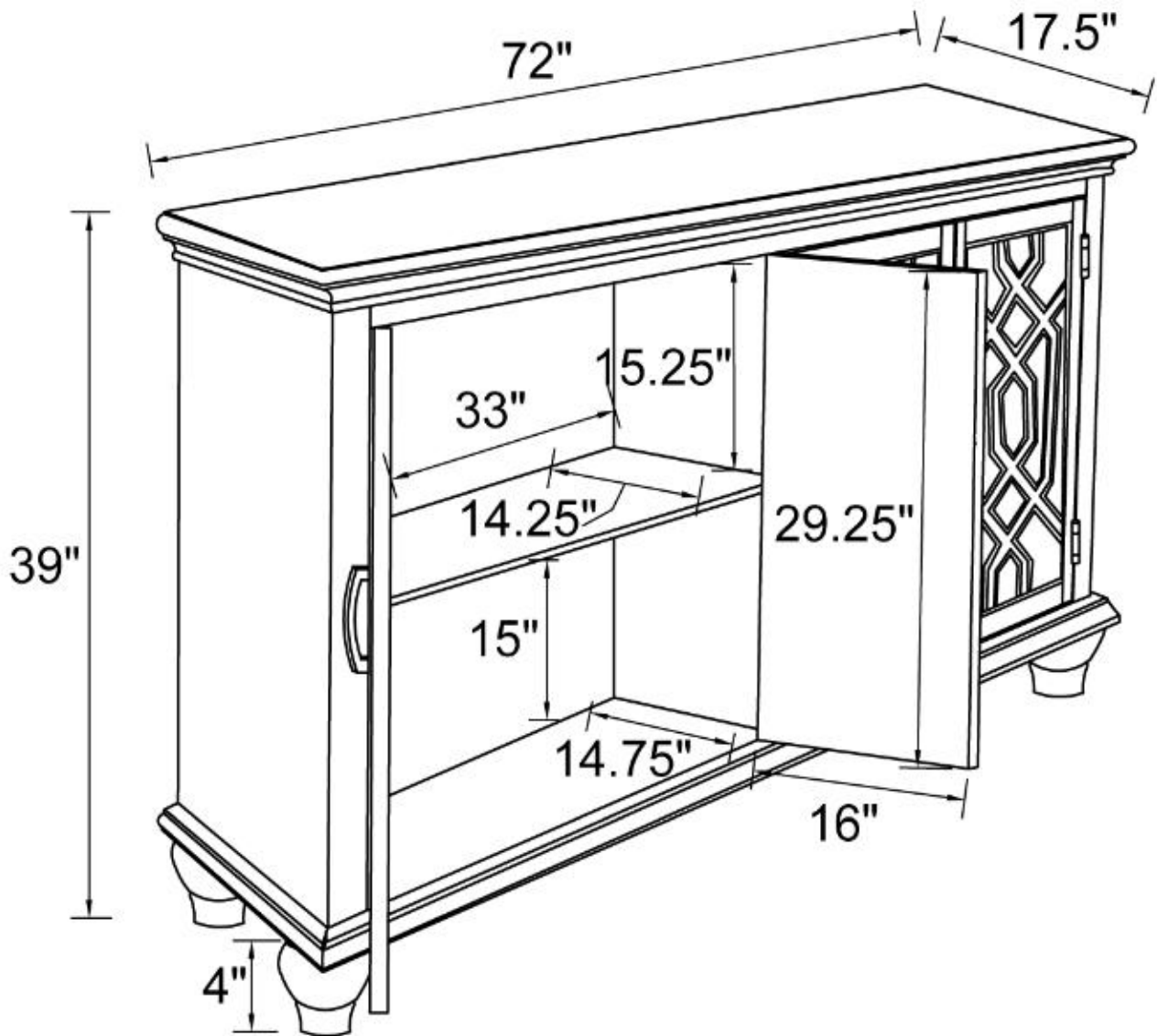

Note: Dimension tolerance  $\pm 5\%$