

ASSEMBLY INSTRUCTIONS
COASTER FINE FURNITURE

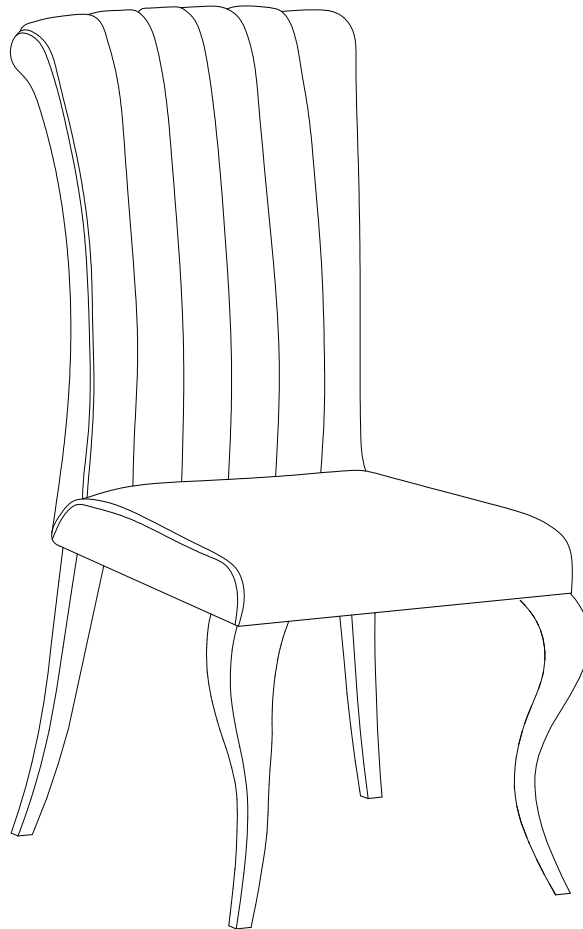

Fine Furniture for every stage of life

105077(B1-B2)
Dining Chair

ITEM: **105077(B1-B2)**

ASSEMBLY INSTRUCTIONS

ASSEMBLY TIPS:

1. Remove hardware from box and sort by size.
2. Please check to see that all hardware and parts are present prior to start of assembly.
3. Please follow attached instructions in the same sequence as numbered to assure fast & easy assembly.



WARNING!

1. Don't attempt to repair or modify parts that are broken or defective. Please contact the store immediately.
2. This product is for home use only and not intended for commercial establishments.

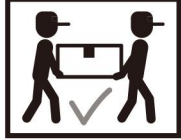

ASSEMBLY TIME

5 MINUTES

PARTS IDENTIFICATION

B1(BOX 1)

A SEAT AND BACK

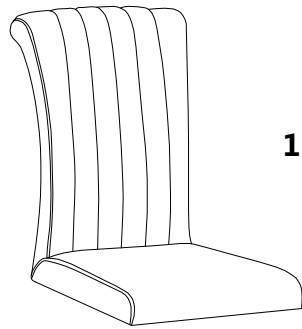

1PC

B BASE

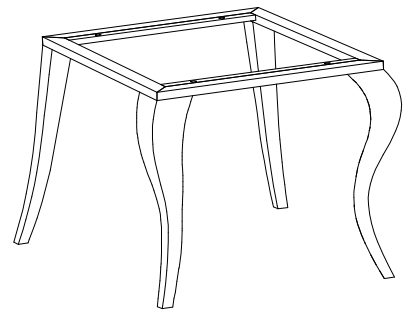

1PC

Z HARDWARE IDENTIFICATION

B2(BOX 2)-HARDWARE PACK IS LOCATED IN 105077(B2)

1 BOLTS M6*25

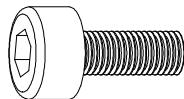

4PCS

2 FLAT WASHER Ø6*16



4PCS

3 ALLEN WRENCH 4MM

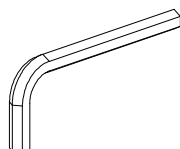

1PC

ITEM: 105077(B1-B2)

ASSEMBLY INSTRUCTIONS



STEP 1

