

ASSEMBLY INSTRUCTIONS
COASTER FINE FURNITURE

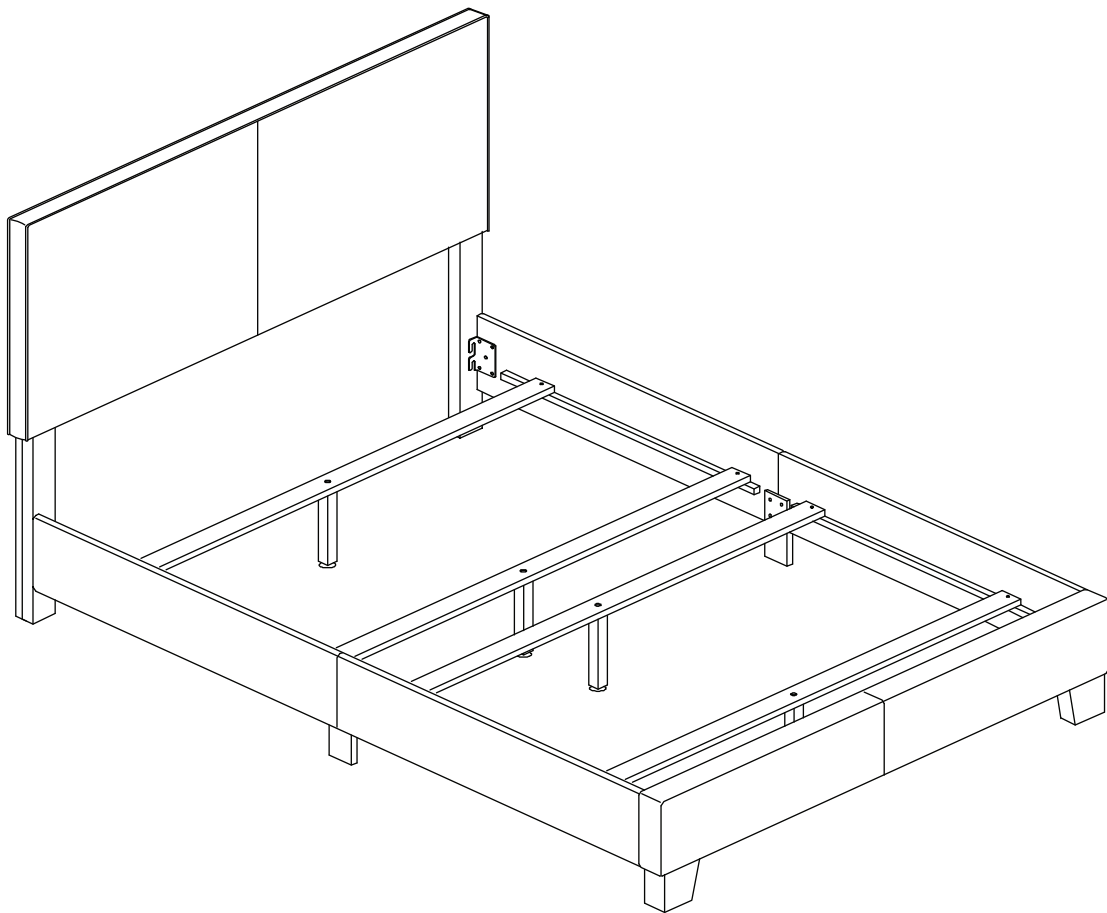

Fine Furniture for every stage of life

300763F
Full Bed

ITEM: **300763F**



ASSEMBLY INSTRUCTIONS

ASSEMBLY TIPS:

1. Remove hardware from box and sort by size.
2. Please check to see that all hardware and parts are present prior to start of assembly.
3. Please follow attached instructions in the same sequence as numbered to assure fast & easy assembly.



WARNING!







1. Don't attempt to repair or modify parts that are broken or defective. Please contact the store immediately.
2. This product is for home use only and not intended for commercial establishments.

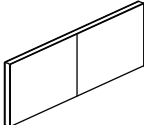
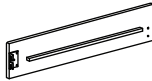

ASSEMBLY TIME

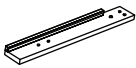
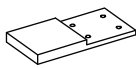
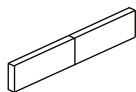
20 MINUTES

PARTS IDENTIFICATION

A	HEADBOARD PANEL		1PC	F	BED RAIL (WITH "F" LABEL)		2PCS
B	LEFT HEADBOARD LEG (WITH "L" LABEL)		1PC	G	BED RAIL (WITH "G" LABEL)		2PCS
C	RIGHT HEADBOARD LEG (WITH "R" LABEL)		1PC	H	BED RAIL SUPPORT LEG		2PCS
D	FOOTBOARD PANEL		1PC	I	BED SLAT		4PCS
E	FOOTBOARD LEG		2PCS	J	BED SLAT SUPPORT WITH LEVELER		4PCS

NOTE:

Phillips head screw driver is required in the assembly process; however, manufacturer does not provided this item.

ASSEMBLY INSTRUCTIONS

ASSEMBLY TIPS:











1. Remove hardware from box and sort by size.
2. Please check to see that all hardware and parts are present prior to start of assembly.
3. Please follow attached instructions in the same sequence as numbered to assure fast & easy assembly.

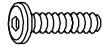

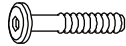
WARNING!

1. Don't attempt to repair or modify parts that are broken or defective. Please contact the store immediately.
2. This product is for home use only and not intended for commercial establishments.

HARDWARE IDENTIFICATION

1	BOLT 1 (M8 x 20mm - RBW)		8PCS	6	LOCK WASHER (1/4" X 12 Ø - RBW)		14PCS
2	BOLT 2 (M6 x 25mm - RBW)		8PCS	7	FLAT WASHER (1/4" X 19 Ø - RBW)		14PCS
3	BOLT 3 (M6 x 35mm - RBW)		10PCS	8	FLAT HEAD SCREW (M4 x 32mm - RBW)		8PCS
4	BOLT 4 (M6 x 70mm - RBW)		2PCS	9	SMALL ALLEN WRENCH (M4 x 100mm - BLK)		1PC
5	WOOD DOWEL (M8Ø x 30mm)		2PCS	10	BIG ALLEN WRENCH (M5 x 65mm - BLK)		1PC

NOTE:

Phillips head screw driver is required in the assembly process; however, manufacturer does not provided this item.

ITEM: **300763F**

ASSEMBLY INSTRUCTIONS

STEP 1

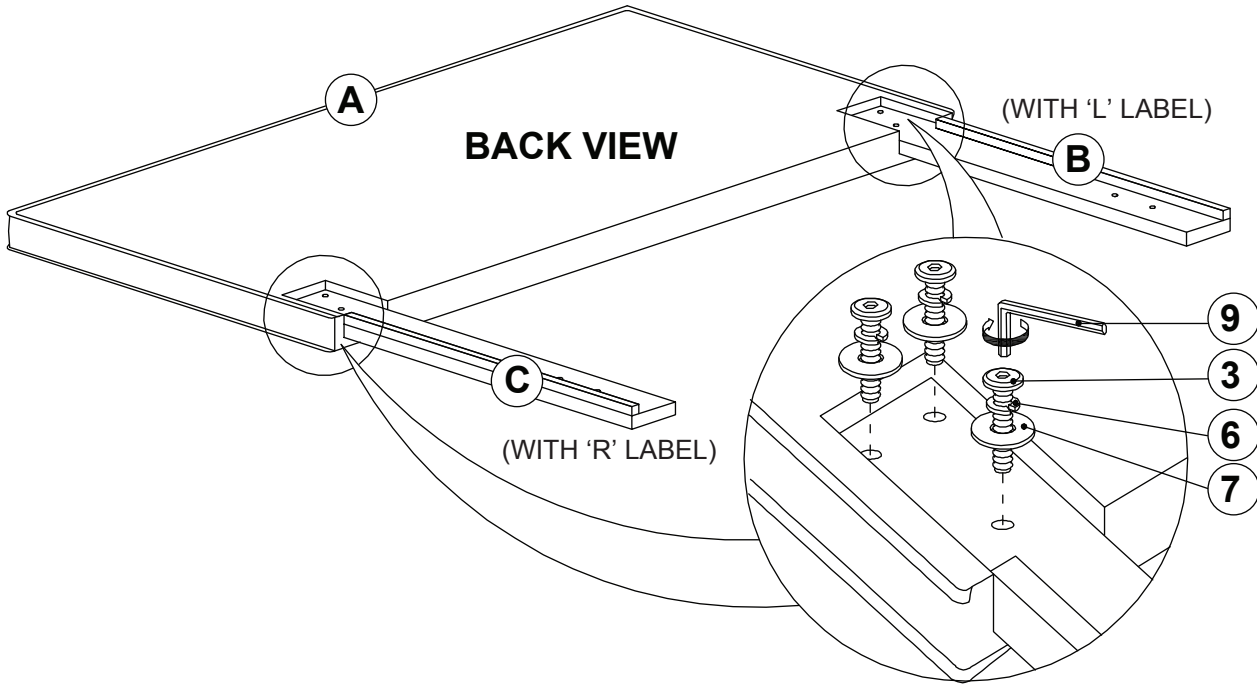

STEP 2

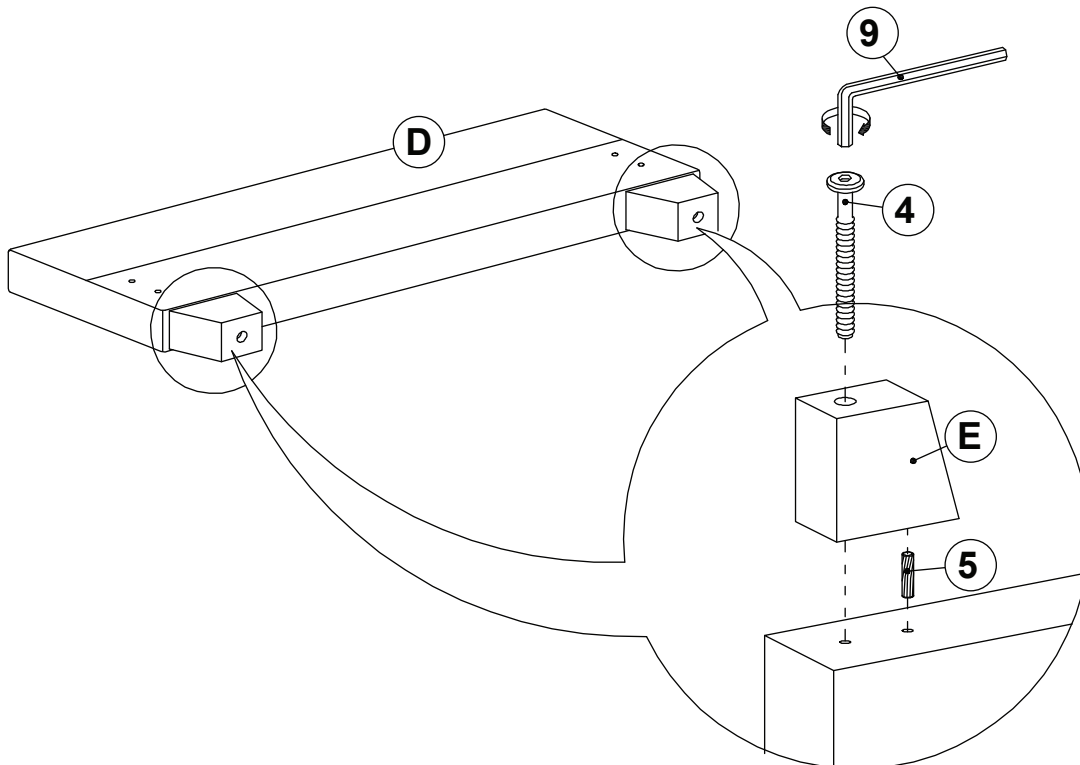

ITEM: **300763F**

ASSEMBLY INSTRUCTIONS

STEP 3

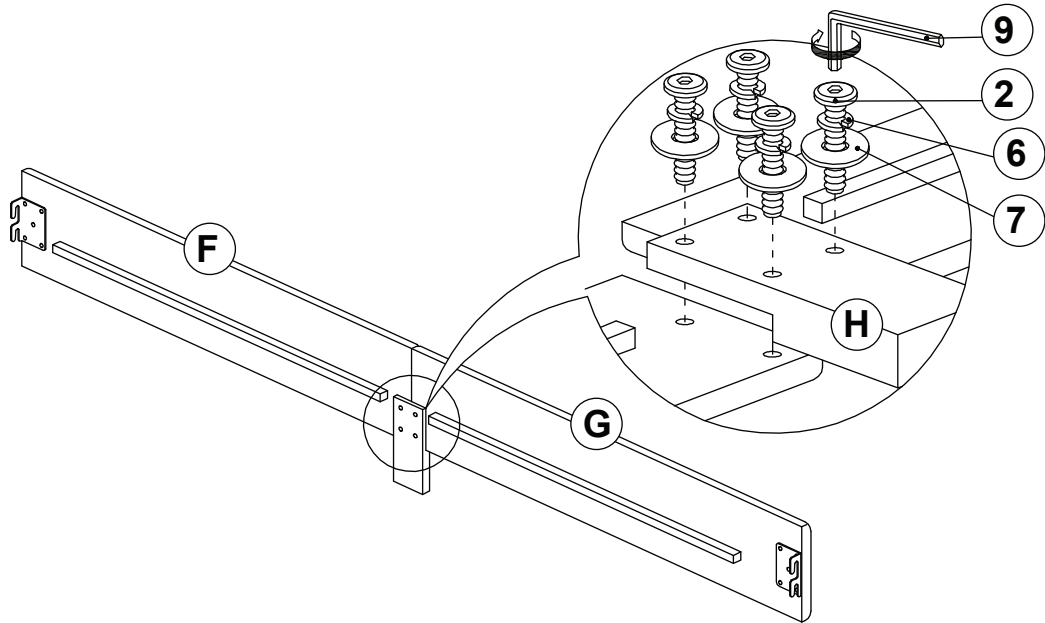

STEP 4

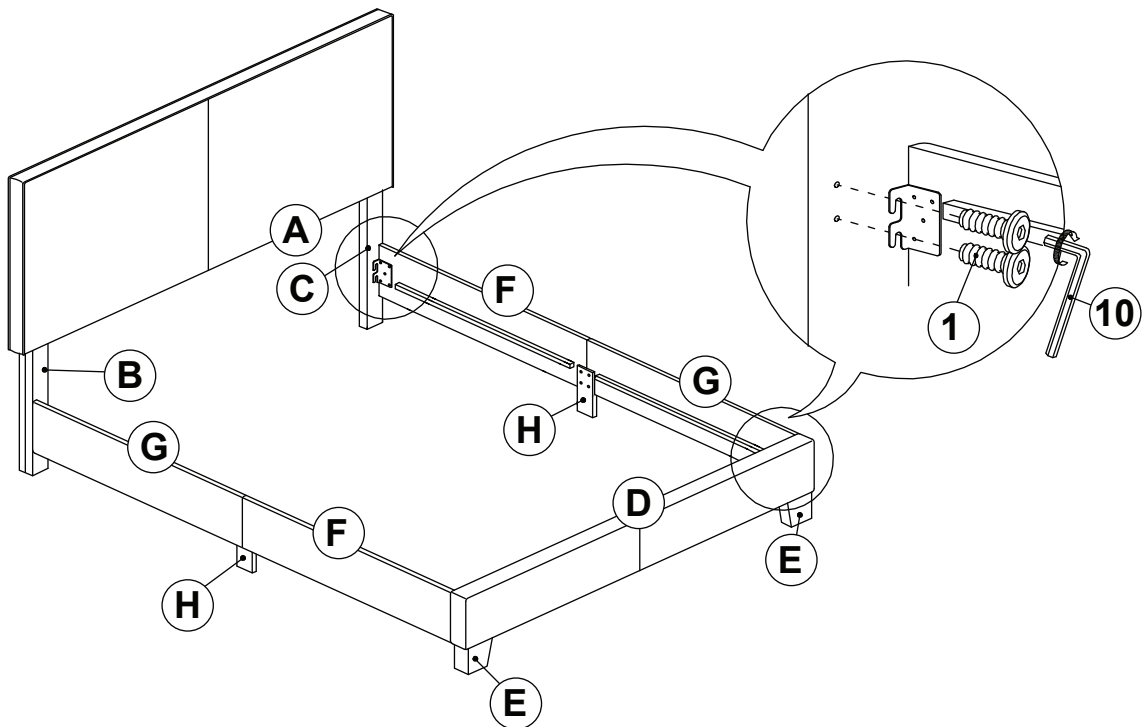

ITEM: **300763F**

ASSEMBLY INSTRUCTIONS

STEP 5

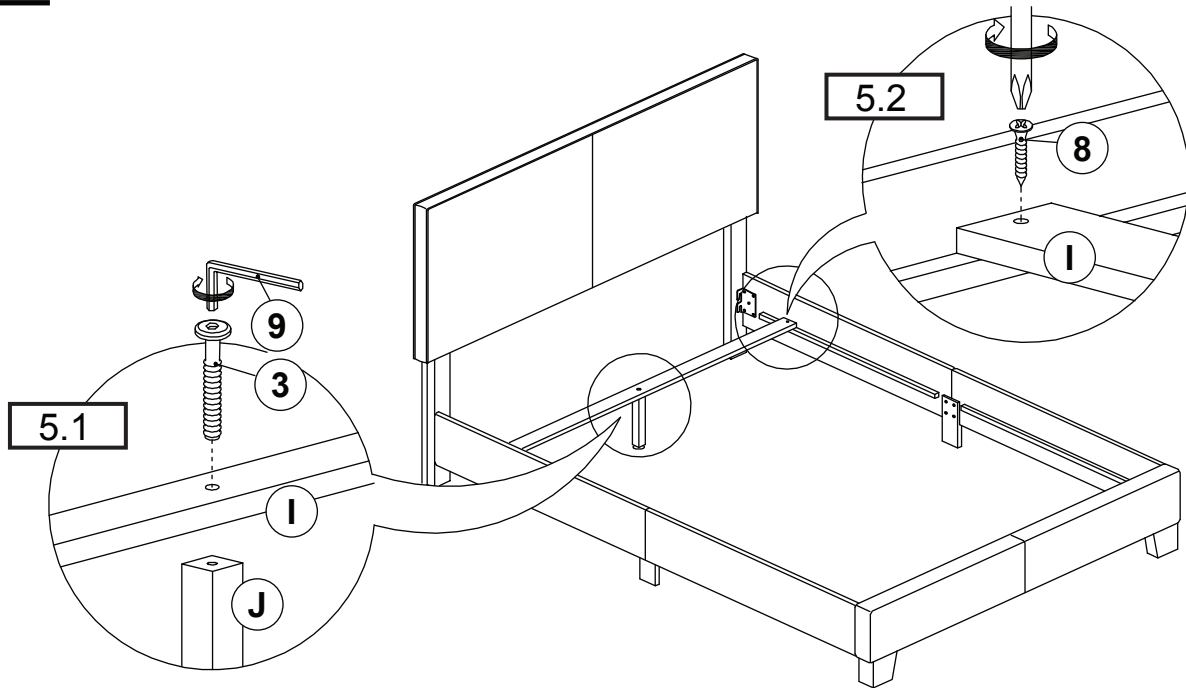

STEP 6

COMPLETE

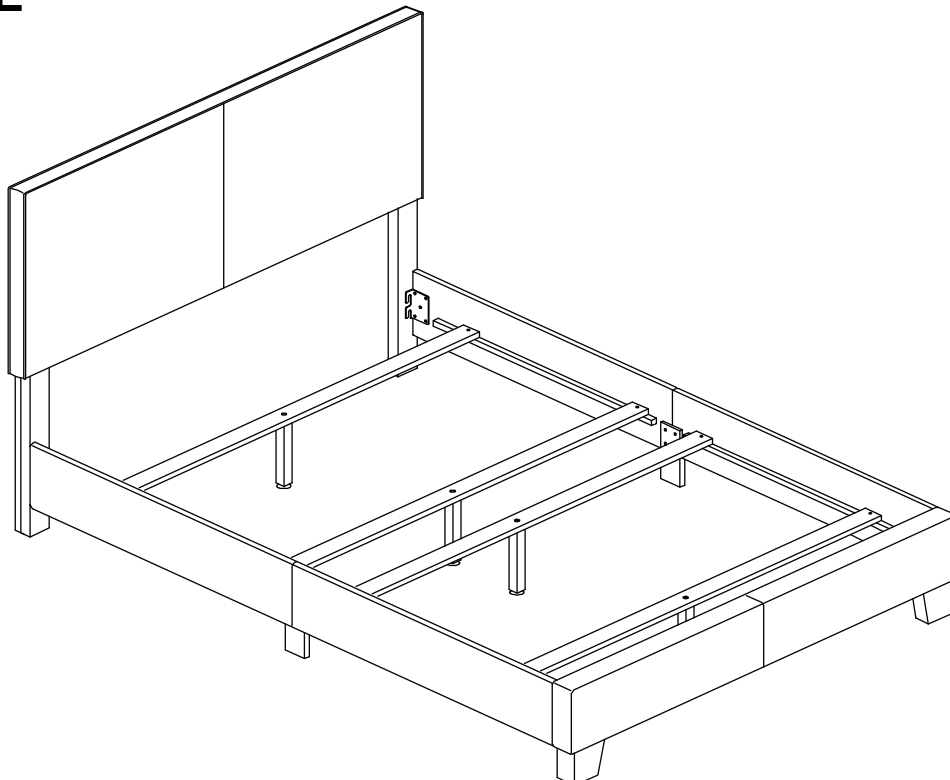

ITEM: **300763F**



Inner Size: 54.50"W X 76.00"D

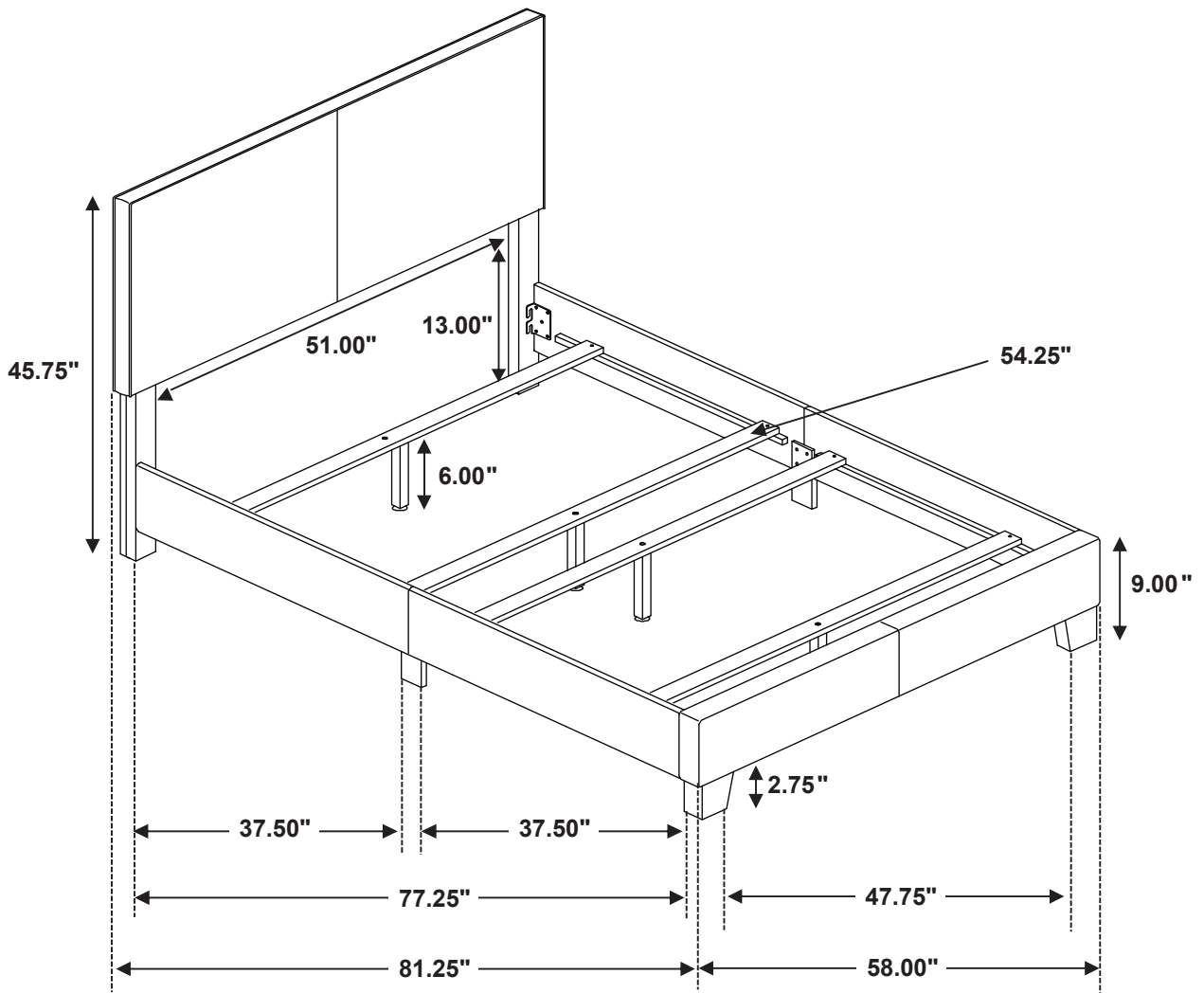

Note: Dimension tolerance $\pm 5\%$