



ASSEMBLY INSTRUCTIONS
COASTER FINE FURNITURE



Fine Furniture for every stage of life

720228
COFFEE TABLE

REVISION 0 : 09/27/2017
REVISION 1 : 11/03/2022

PAGE 1 OF 4

COASTERFURNITURE.COM

ITEM: 720228



ASSEMBLY INSTRUCTIONS

ASSEMBLY TIPS:

1. Remove hardware from box and sort by size.
2. Please check to see that all hardware and parts are present prior to start of assembly.
3. Please follow attached instructions in the same sequence as numbered to assure fast & easy assembly.



WARNING!

1. Don't attempt to repair or modify parts that are broken or defective. Please contact the store immediately.
2. This product is for home use only and not intended for commercial establishments.

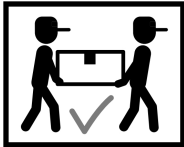

ASSEMBLY TIME 30 MINUTES

PARTS IDENTIFICATION

A TOP GLASS

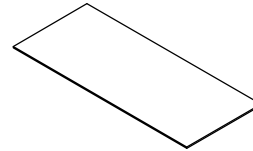

1PC

B SHELF GLASS

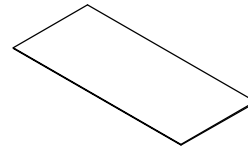

1PC

C SIDE FRAME

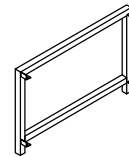

2PCS

D CROSSBAR

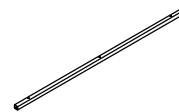

4PCS

HARDWARE IDENTIFICATION

1 BOLT
(1/4" x 12mm BLK)



8PCS

3 CAP
(25 x 25mm BLK)



4PCS

2 SUCTION CUP
(9mm)



12PCS

4 ALLEN WRENCH
(4mm)



1PC

ITEM: 720228 ASSEMBLY INSTRUCTIONS



STEP 1 Do not tighten until each step is completed or instructed.

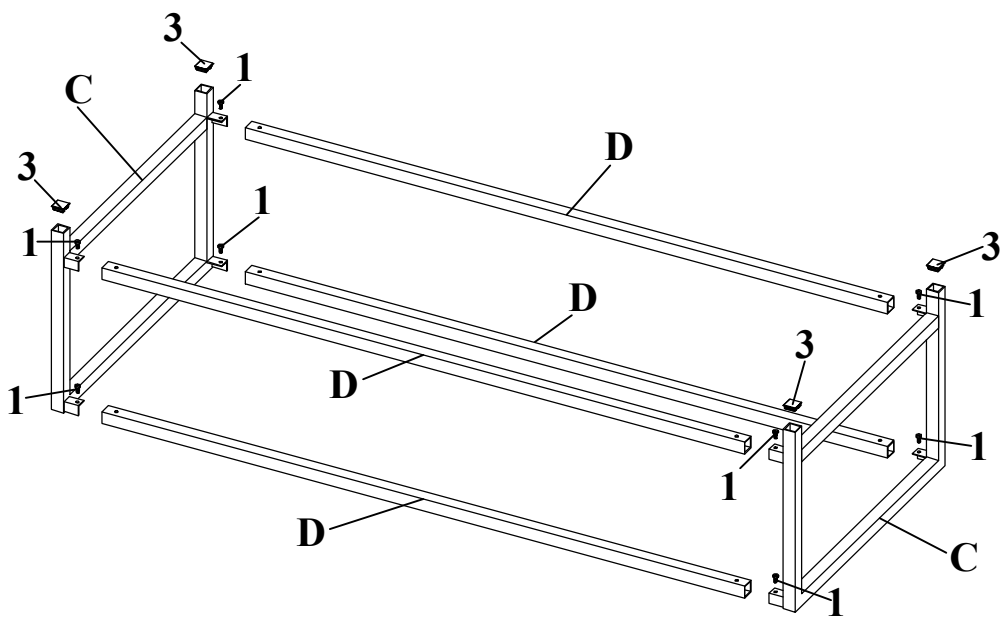

STEP 2

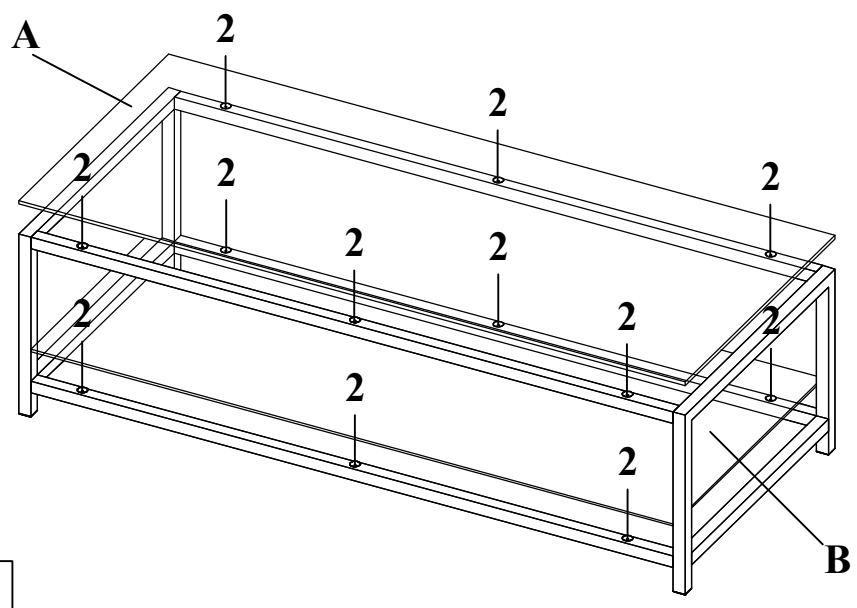

ITEM: 720228 ASSEMBLY INSTRUCTIONS



Product Size : 1372 X 584 X 381 H (MM)

Product Size : 54" X 23" X 15"

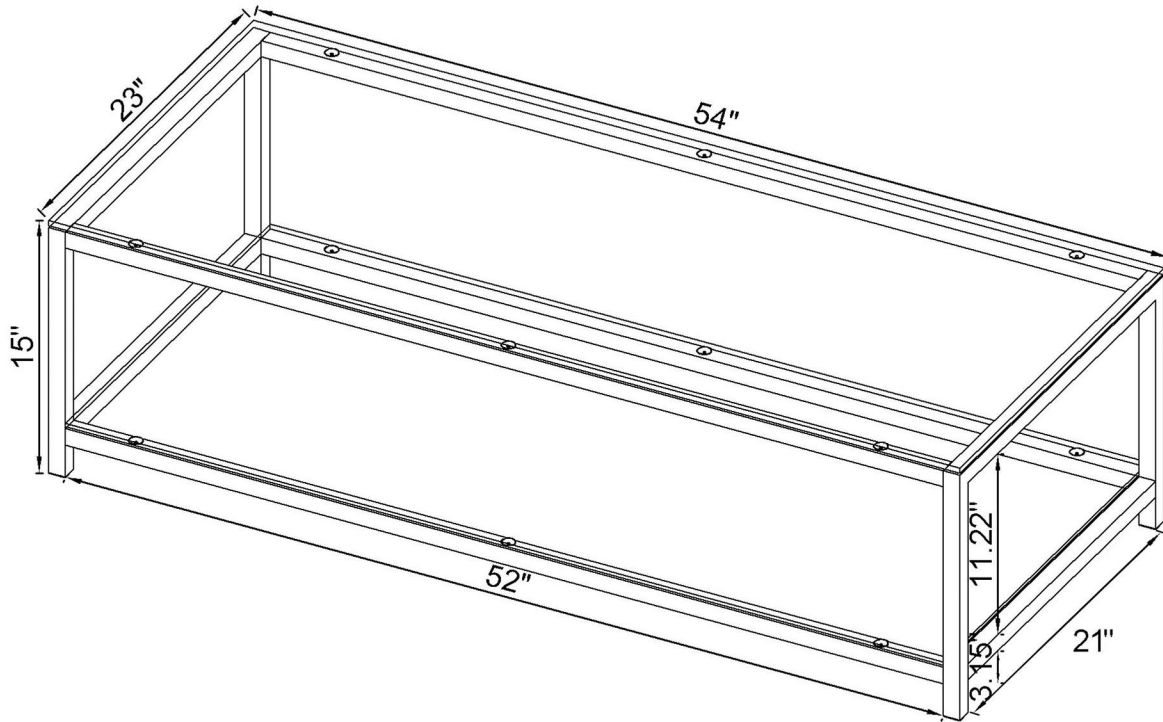

Note : Dimension tolerance $\pm 5\%$