

ASSEMBLY INSTRUCTIONS
COASTER FINE FURNITURE



Fine Furniture for every stage of life

360281
Sofa Bed

ITEM: 360281



ASSEMBLY INSTRUCTIONS

ASSEMBLY TIPS:

1. Remove hardware from box and sort by size.
2. Please check to see that all hardware and parts are present prior to start of assembly.
3. Please follow attached instructions in the same sequence as numbered to assure fast & easy assembly.



WARNING!

1. Don't attempt to repair or modify parts that are broken or defective. Please contact the store immediately.
2. This product is for home use only and not intended for commercial establishments.

ASSEMBLY TIME

15 MINUTES

PARTS IDENTIFICATION

A SOFA BED

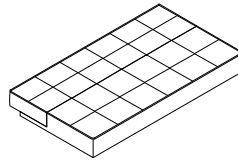

1PC

B FRONT LEG

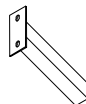

2PCS

C BACK LEG



2PCS

HARDWARE IDENTIFICATION

1 BOLT
(M8 x 30mm - RBW)



4PCS

2 LOCK WASHER
(Ø5/16"-RBW)



4PCS

3 FLAT WASHER
(Ø5/16"-RBW)



4PCS

4 ALLEN WRENCH
(5mm - RBW)



1PC

ITEM: 360281

ASSEMBLY INSTRUCTIONS

STEP 1

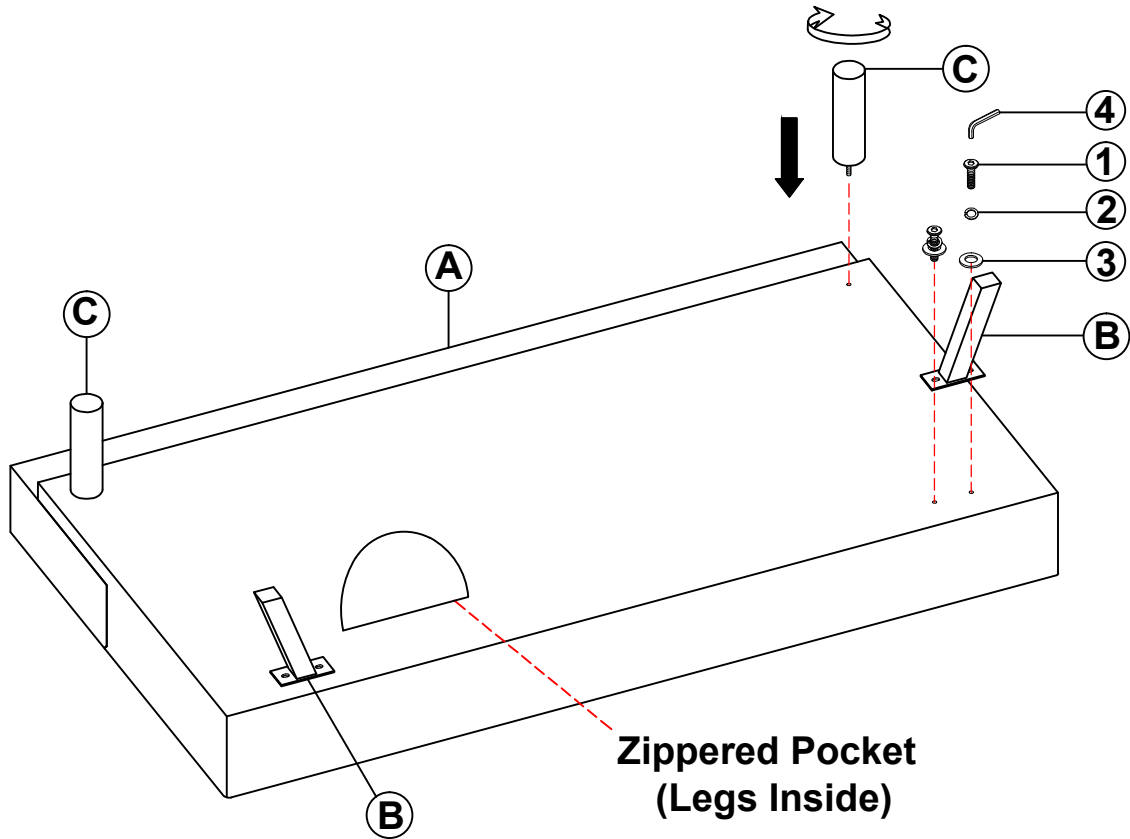

STEP 2

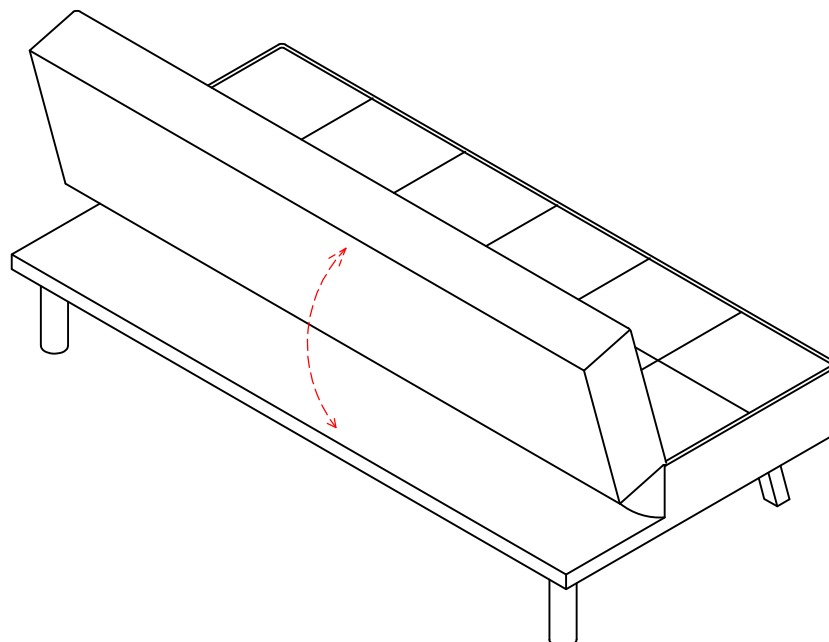

ITEM: 360281

ASSEMBLY INSTRUCTIONS

STEP 3

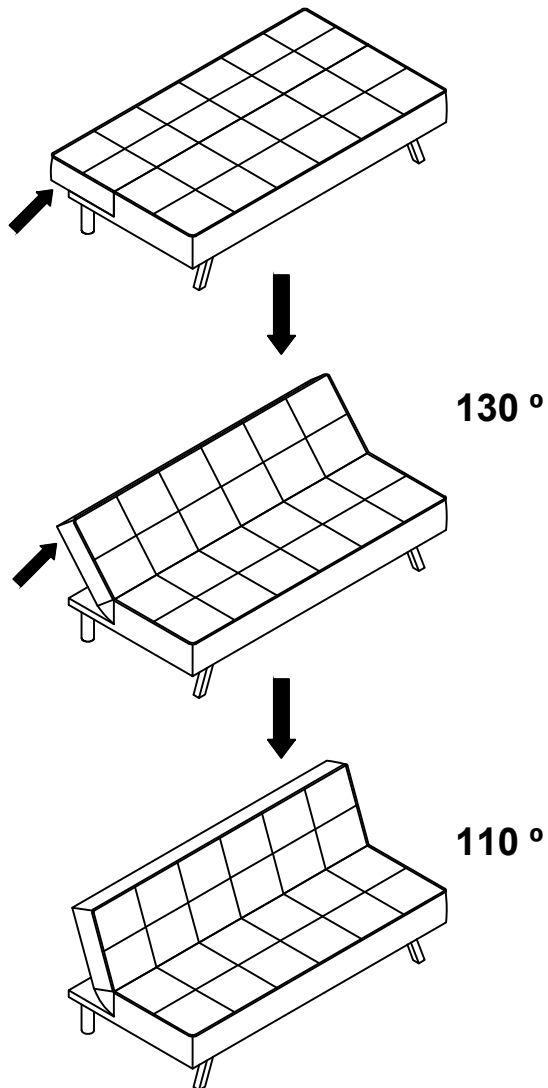

STEP 4

COMPLETE

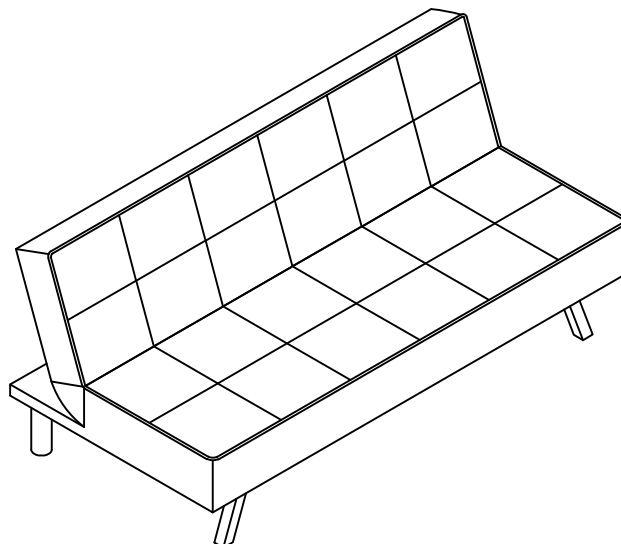

ITEM: 360281

COASTER
FINE FURNITURE

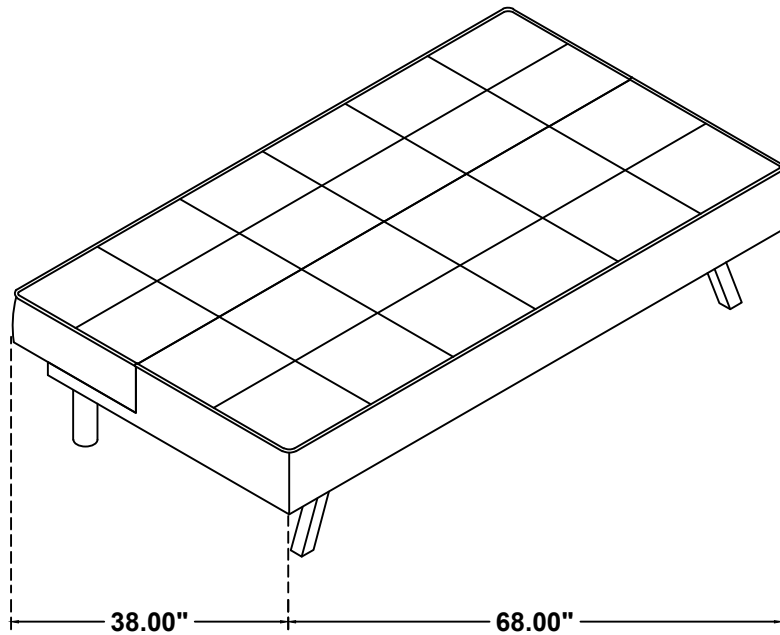
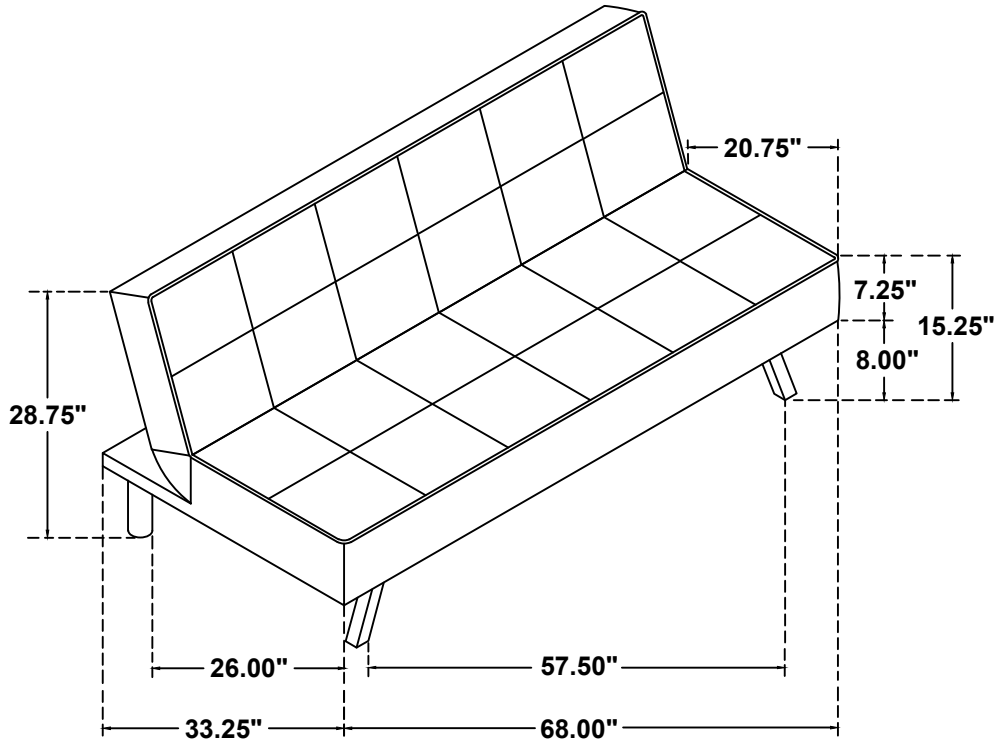

Note: Dimension tolerance $\pm 5\%$