

# ASSEMBLY INSTRUCTIONS COASTER FINE FURNITURE



Fine Furniture for every stage of life

120696  
BARSTOOL

REVISION:06/16/2020  
REVISION:08/04/2022

COASTERFURNITURE.COM

**ITEM :120696**  
**ASSEMBLY INSTRUCTIONS**



**ASSEMBLY TIPS:**

1. Remove hardware from box and sort by size.
2. Please check to see that all hardware and parts are present prior to start of assembly.
3. Please follow attached instructions in the same sequence as numbered to assure fast & easy assembly.







**Warning!**

1. Don't attempt to repair or modify parts that are broken or defective. Please contact the store immediately.
2. This product is for home use only and not intended for commercial establishments.



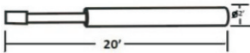

**ASSEMBLY TIME 5 MINUTES**

**PARTS IDENTIFICATION**

	<b>PART NAME</b>	<b>FIGURE</b>	<b>QTY</b>
<b>A</b>	<b>SEAT AND BACK</b>		<b>1PC</b>
<b>B</b>	<b>FOOT REST</b>		<b>1PC</b>
<b>C</b>	<b>GAS CYLINDER</b>		<b>1PC</b>
<b>D</b>	<b>BASE</b>		<b>1PC</b>
<b>E</b>	<b>DECORATIVE RING</b>		<b>1PC</b>

**HARDWARE IDENTIFICATION**

	<b>HARDWARE NAME</b>	<b>FIGURE</b>	<b>QTY</b>
<b>1</b>	<b>BOLTS 3/16"x16MM</b>		<b>4PCS</b>
<b>2</b>	<b>ALLEN WRENCH M6</b>		<b>1PC</b>

ITEM :120696  
ASSEMBLY INSTRUCTIONS



STEP1

Remove sheath(black cover)  
before using

C  
E  
D

STEP2

2  
1  
B  
A

STEP3

Firmly push top into  
gas spring

STEP4

ITEM :120696  
ASSEMBLY INSTRUCTIONS

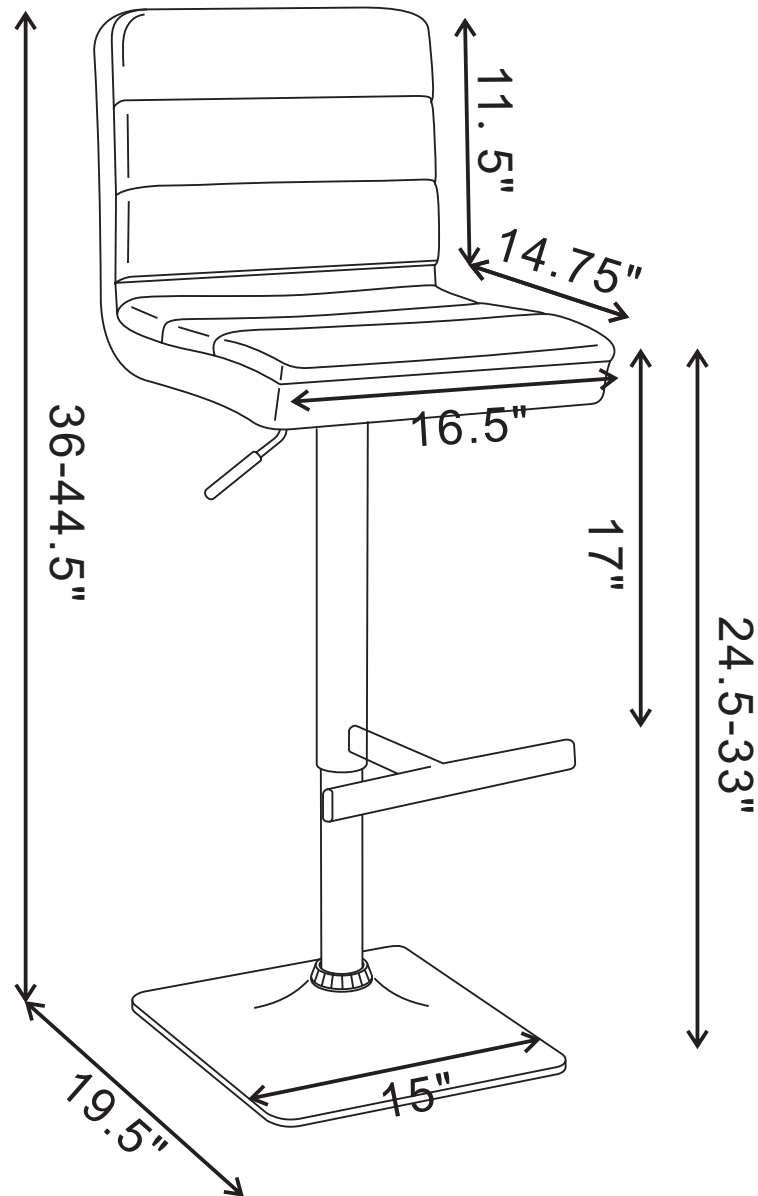

Note:Dimension tolerance±5%

COASTERFURNITURE.COM