



ASSEMBLY INSTRUCTIONS
COASTER FINE FURNITURE



Fine Furniture for every stage of life

552001
Sofa

ASSEMBLY INSTRUCTIONS

ASSEMBLY TIPS:

1. Remove hardware from box and sort by size
2. Please check to see that all hardware and parts are present prior to start of assembly.
3. Please follow attached instruction in the same sequence as numbered to assure fast & easy assembly.



Warning!

1. Don't attempt to repair or modify parts that are broken or defective. Please contact the store immediately.
2. This product is for home use only and not intended for commercial establishment

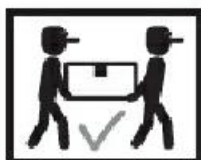









ASSEMBLY TIME

15 MINUTES

PARTS IDENTIFICATION:

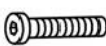
ZN HARDWARE PACKAGE

- A**  **BASE 1PC**
- B**  **BACK CUSHION 3PCS**
- C**  **LEG 4PCS**
- D**  **MIDDLE LEG 1PC**
- E**  **PILLOW 2PCS**

NO	DESCRIPTION	FIGURE	QTY
1	BOLT (M8*35mm)		8PCS
2	FLAT WASHER (M8)		8PCS
3	SPRING WASHER (M8)		8PCS
4	ALLEN KEY (M8)		1PC

ITEM:552001

ASSEMBLY INSTRUCTIONS

STEP 1

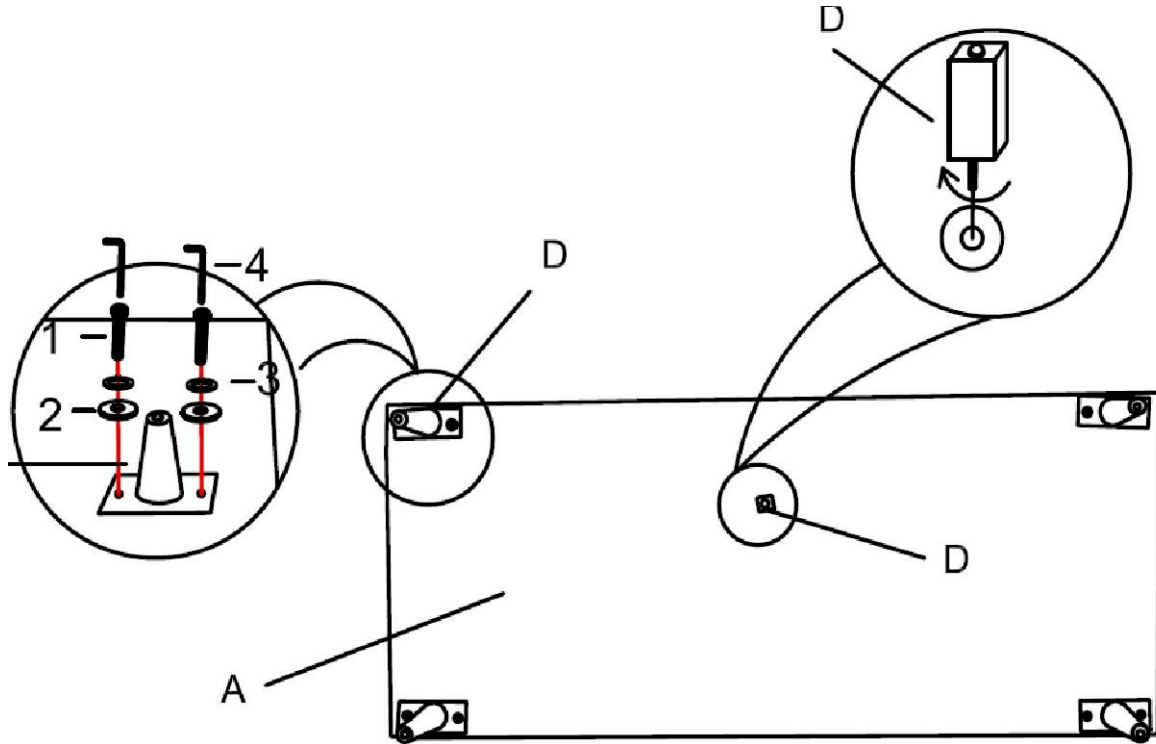

STEP 2

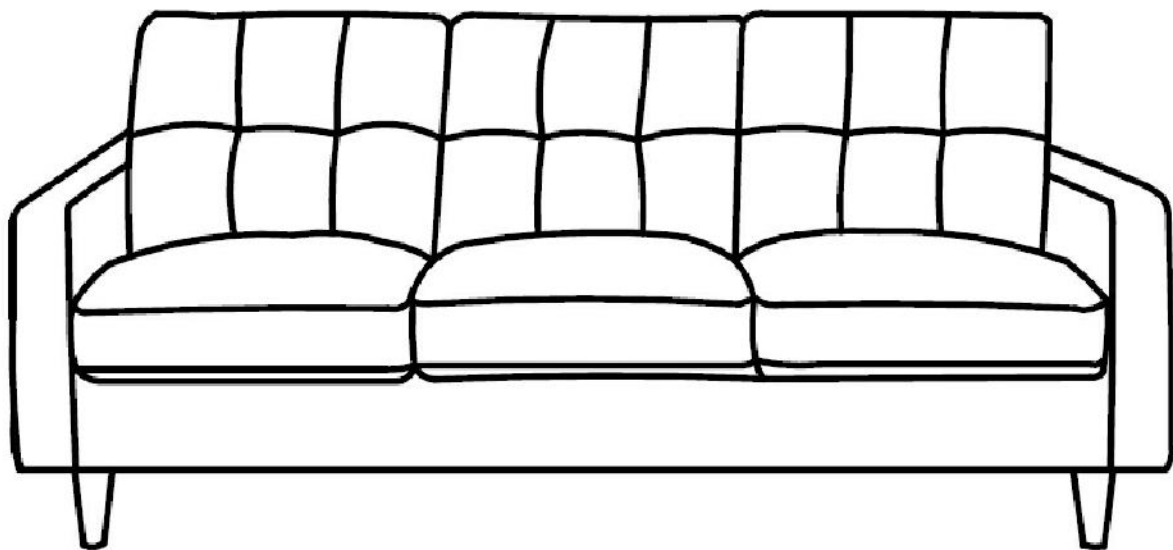

ITEM NO: 552001

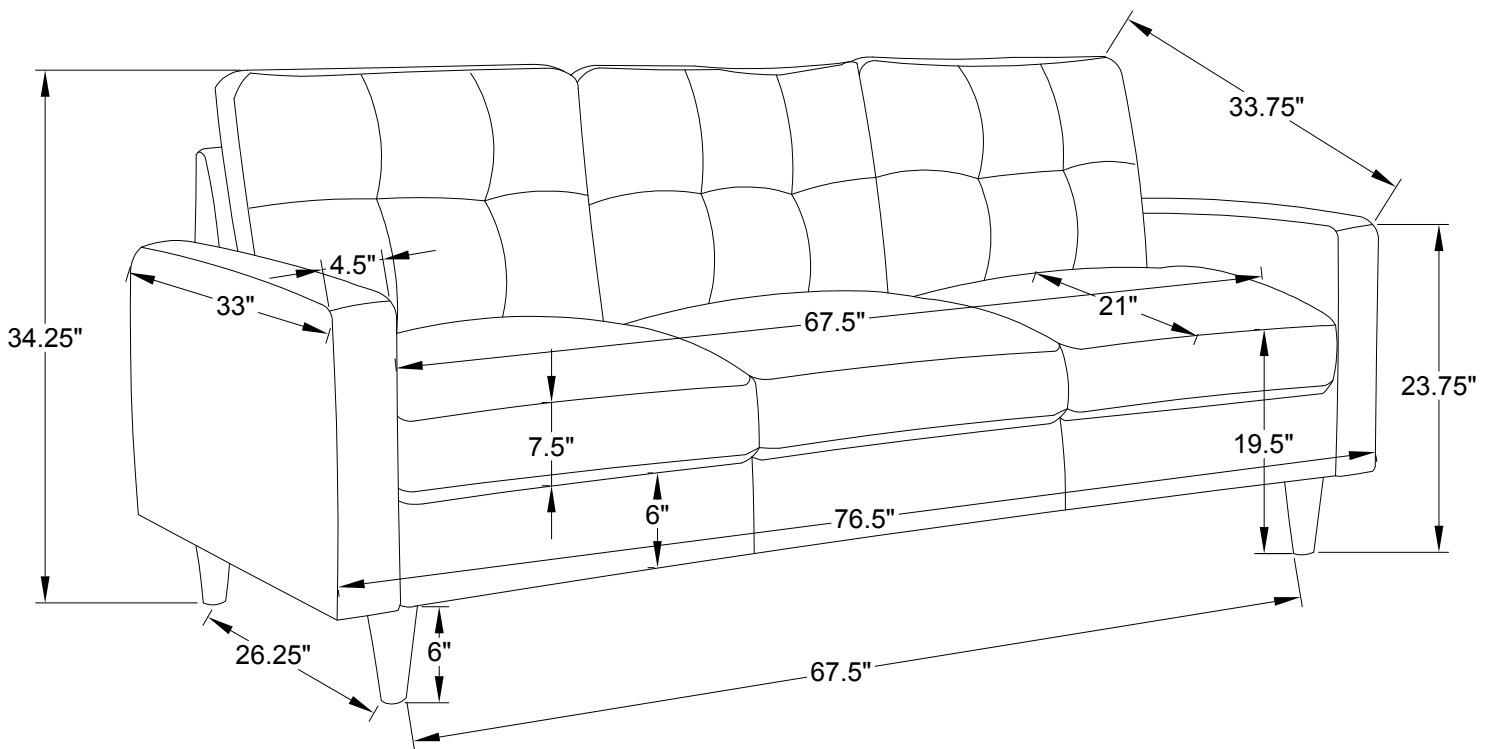

Note: Dimension tolerance $\pm 5\%$