

ASSEMBLY INSTRUCTIONS
COASTER FINE FURNITURE

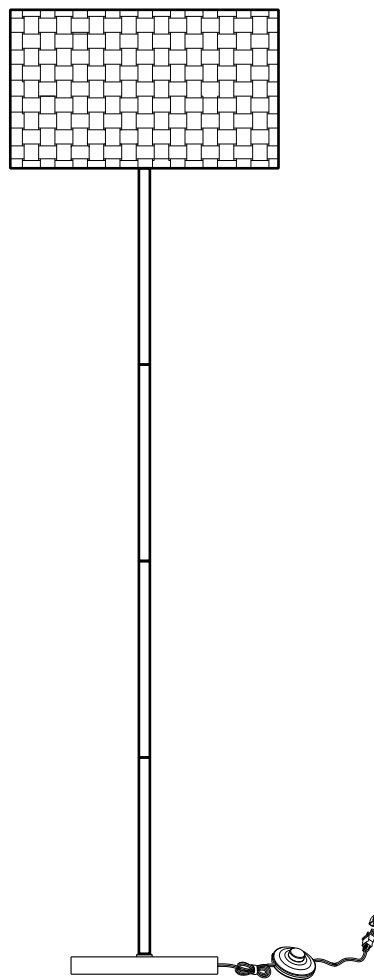

Fine Furniture for every stage of life

REVISION 1:02/20/2023

920303
FLOOR LAMP

ITEM :920303

ASSEMBLY INSTRUCTIONS

ASSEMBLY TIPS:

1. Remove hardware from box and sort by size.
2. Please check to see that all hardware and parts are present prior to start of assembly.
3. Please follow attached instructions in the same sequence as numbered to assure fast & easy assembly.

WARNING!



1. Don't attempt to repair or modify parts that are broken or defective. Please contact the store immediately
2. This product is for home use only and not intended for commercial establishments.

ASSEMBLY TIME

8 MINUTES

PARTS IDENTIFICATION

A LAMP BODY

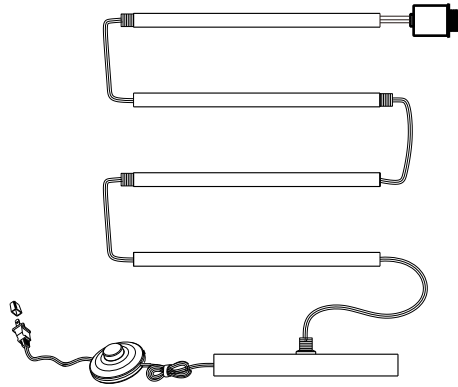

1PC

B SHADE

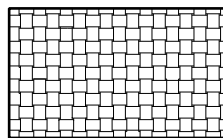

1PC

C SOCKET RING



1PC

D LIGHT BULB

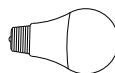

1PC

ITEM :920303

ASSEMBLY INSTRUCTIONS

STEP1

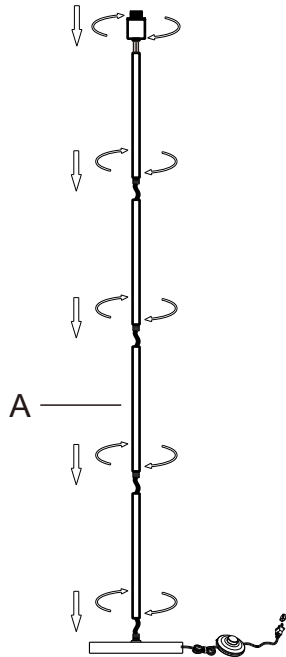

STEP2

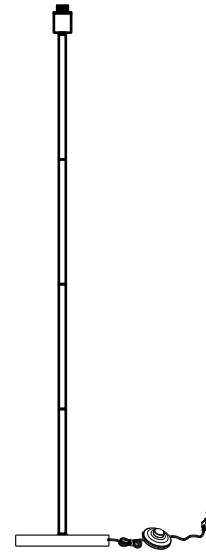

STEP3

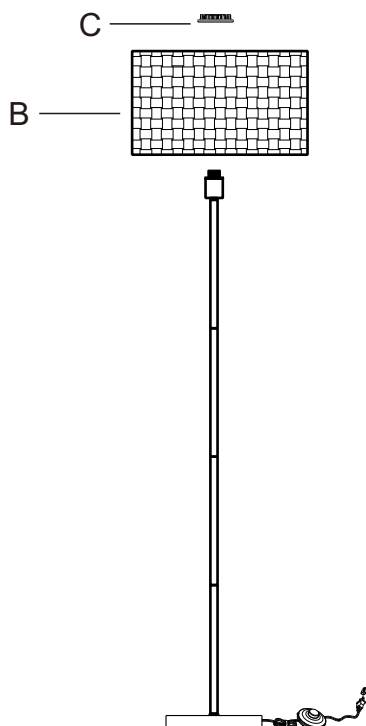

STEP4

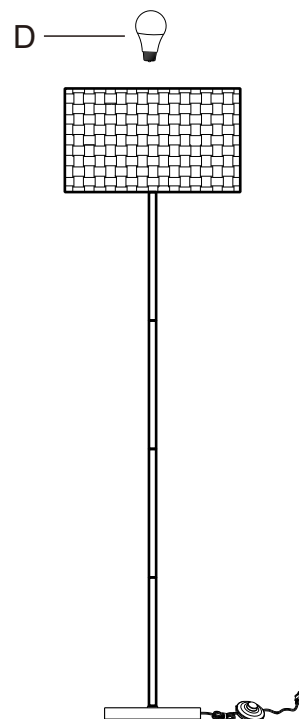

As a safety feature, and to reduce the risk of electric shock, this portable lamp includes a polarized plug (one blade is wider than the other). The plug will fit into a polarized outlet in a single direction only. If the plug does not fit fully in the outlet, reverse the plug and try again. If it still does not fit, contact a qualified electrician. **DO NOT** use with an extension cord unless, can be fully inserted. **DO NOT** alter the plug

FLOOR LAMP:TYPE A LED BULB 9W

ITEM :920303

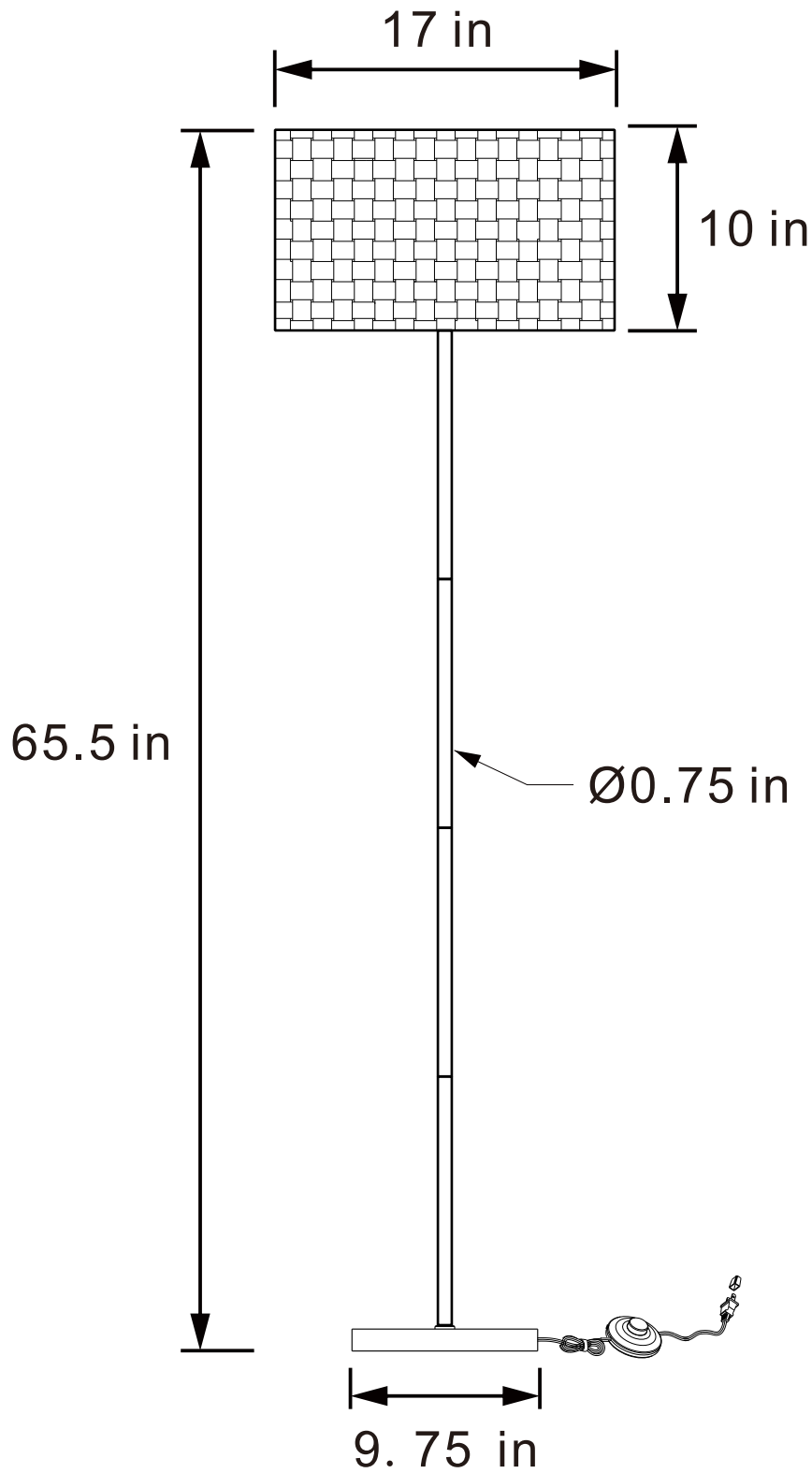

Note : Dimension tolerance $\pm 5\%$