

ASSEMBLY INSTRUCTIONS
COASTER FINE FURNITURE



Fine Furniture for every stage of life

422759F
FULL BED

ITEM: 422759F



ASSEMBLY INSTRUCTIONS

ASSEMBLY TIPS:

1. Remove hardware from box and sort by size.
2. Please check to see that all hardware and parts are present prior to start of assembly.
3. Please follow attached instructions in the same sequence as numbered to assure fast & easy assembly.



WARNING!

















1. Don't attempt to repair or modify parts that are broken or defective. Please contact the store immediately.
2. This product is for home use only and not intended for commercial establishments.



ASSEMBLY TIME





60 MINUTES

PARTS IDENTIFICATION

A1 LSF HEADBOARD LEG		1PC	B1 RSF HEADBOARD LEG		1PC
C1 LSF FOOTBOARD LEG		1PC	D1 RSF FOOTBOARD LEG		1PC
E1 HEADBOARD		2PCS	F1 RAIL 1		2PCS
G1 RAIL 2		2PCS	H1 SUPPORT LEG		2PCS
I1 CENTER SUPPORT BAR		1PC	J1 SLAT		16PCS
K1 SLAT CONNECTOR		32PCS	L1 FINIAL		4PCS
M1 RAIL METAL JOINT		2PCS	N1 HEADBOARD AND FOOTBOARD SUPPORT BAR		2PCS
O1 CENTER RAIL 1		1PC	P1 CENTER RAIL 2		1PC
Q1 CENTER SUPPORT LEG		3PCS			

HARDWARE IDENTIFICATION

Z - HARDWARE

1 BOLT(Ø 1/4"x13MM)		34PCS	4 ALLEN WRENCH(1/4")		1PC
2 BOLT(Ø 1/4"x36MM)		10PCS	5 OPEN WRENCH(1/4")		1PC
3 BOLT(Ø 1/4")		6PCS			

ITEM: 422759F

ASSEMBLY INSTRUCTIONS



STEP 1

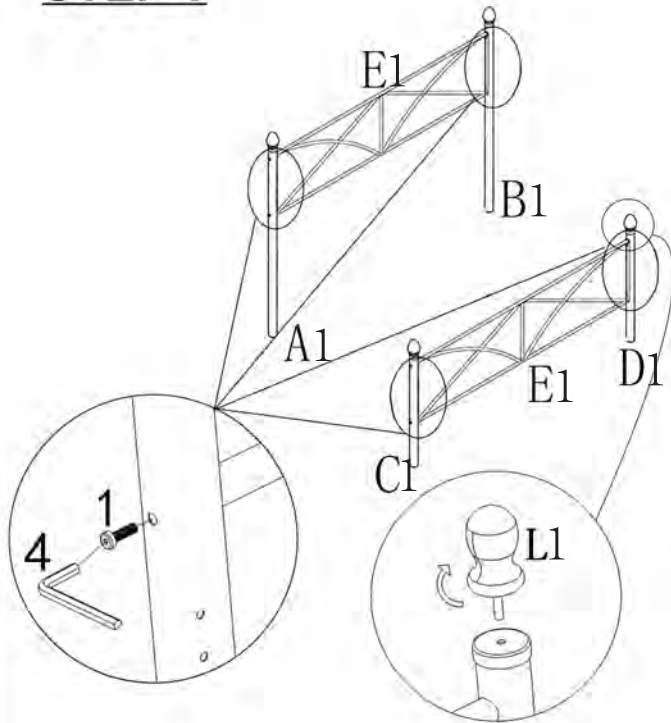

STEP 2

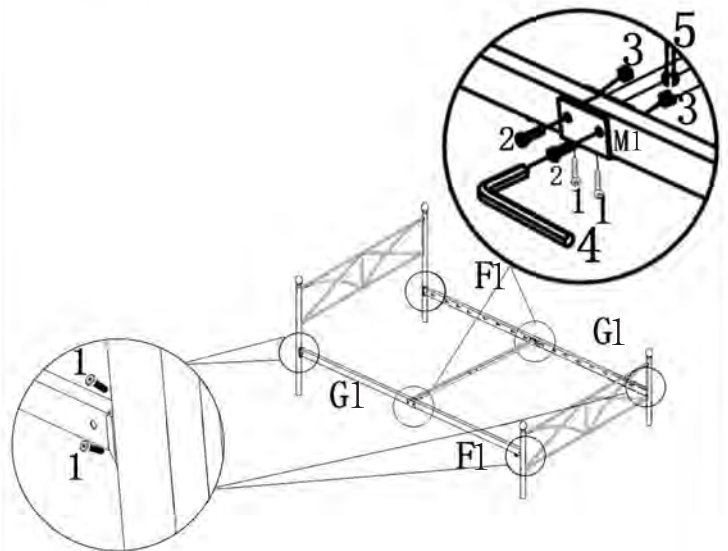

STEP 3

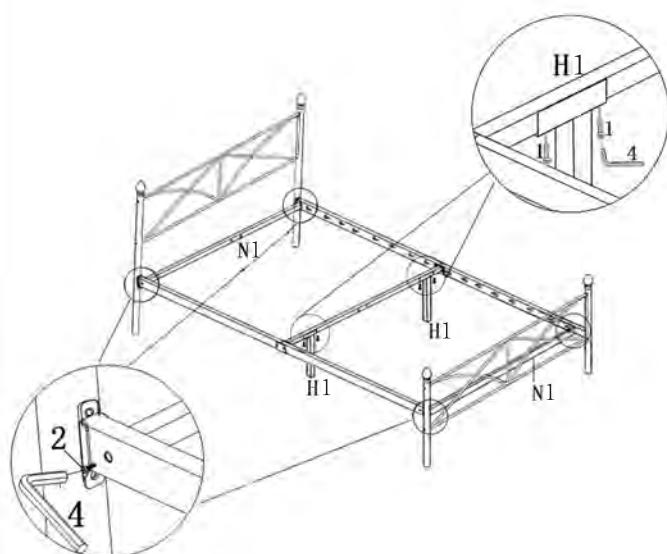

STEP 4

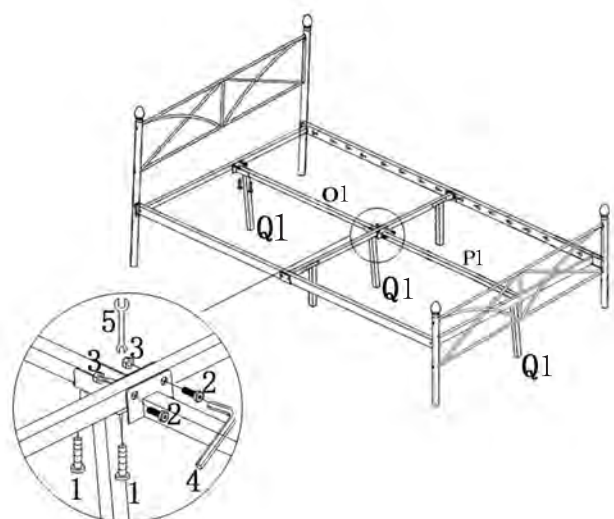

ITEM: 422759F

ASSEMBLY INSTRUCTIONS



STEP 5

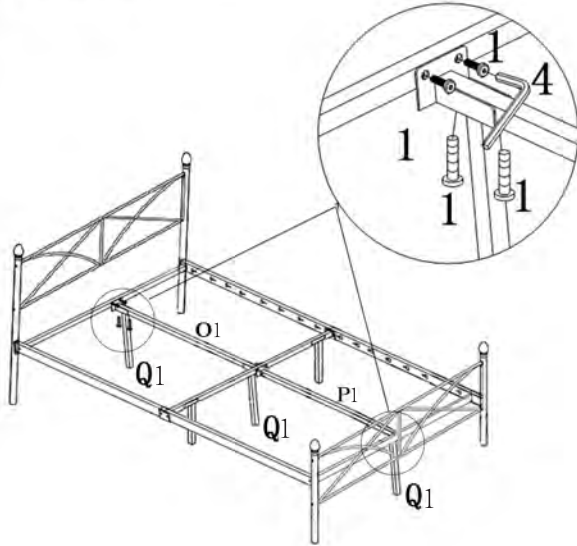

STEP 6

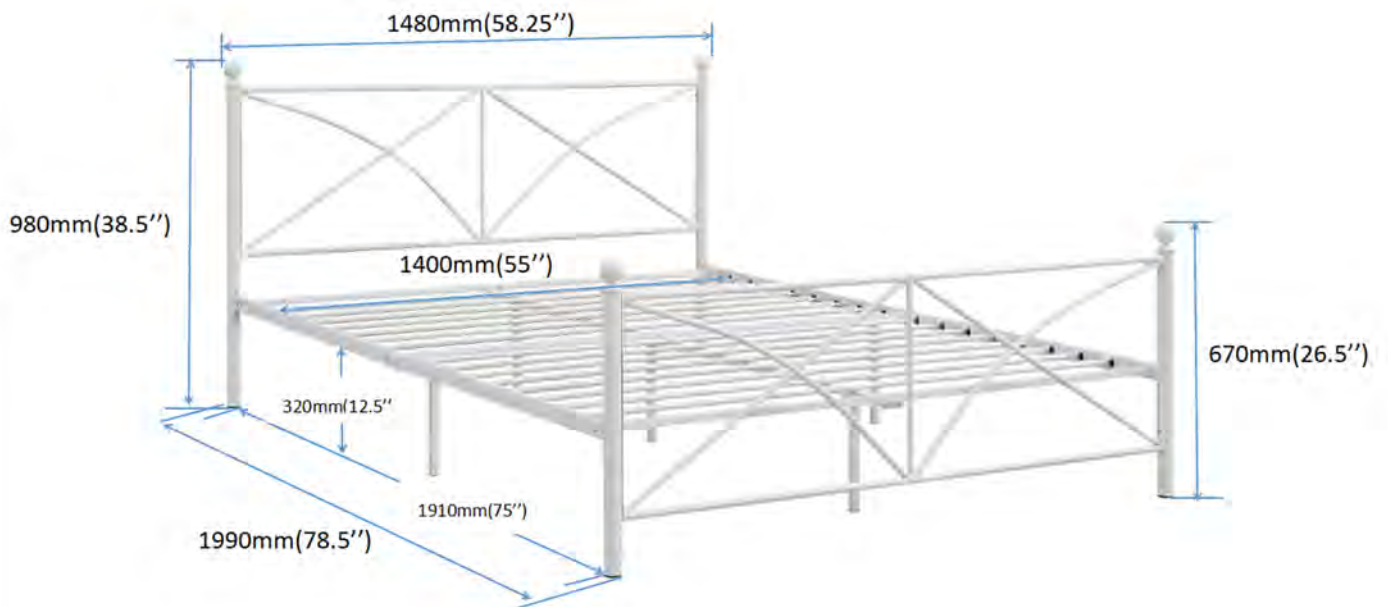
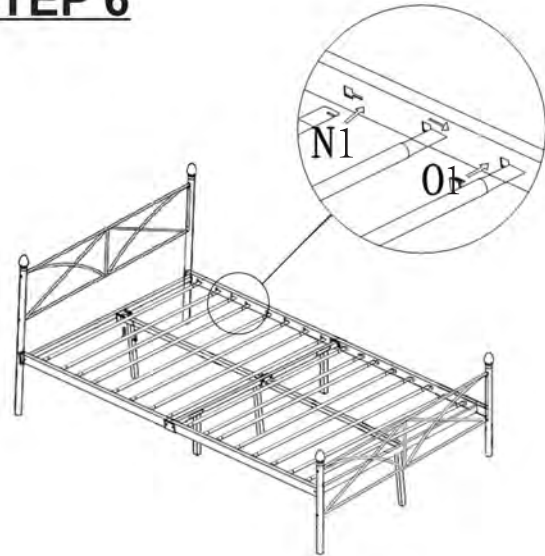

Note : Dimension tolerance $\pm 5\%$

