

ASSEMBLY INSTRUCTIONS
COASTER FINE FURNITURE

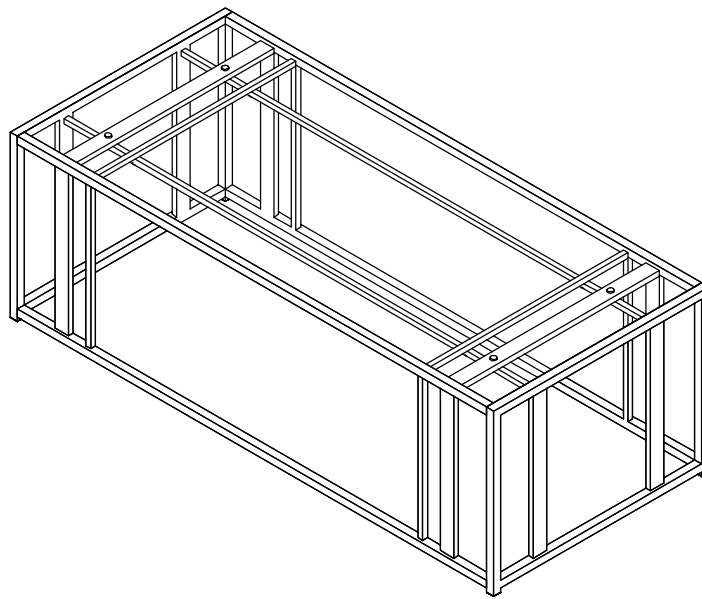

Fine Furniture for every stage of life

708358
COFFEE TABLE

ITEM: 708358



ASSEMBLY INSTRUCTIONS

ASSEMBLY TIPS:

1. Remove hardware from box and sort by size.
2. Please check to see that all hardware and parts are present prior to start of assembly.
3. Please follow attached instructions in the same sequence as numbered to assure fast & easy assembly.



WARNING!

1. Don't attempt to repair or modify parts that are broken or defective. Please contact the store immediately.
2. This product is for home use only and not intended for commercial establishments.



ASSEMBLY TIME 35 MINUTES

PARTS IDENTIFICATION

A	TOP GLASS		1PC
B	SIDE FRAME		2PCS
C	FRONT AND BACK FRAME		2PCS
D	WIDE CROSSBAR		2PCS
E	THIN CROSSBAR		2PCS
F	SUPPORT CROSSBAR		2PCS

ITEM:708358



ASSEMBLY INSTRUCTIONS

HARDWARE IDENTIFICATION

1	SHORT BOLT (1/4" x 12mm)		20PCS
2	LONG BOLT (1/4" x 18mm)		8PCS
3	SUCTION CUP (ϕ 10mm)		4PCS
4	CAP (20 x 20mm)		4PCS
5	ALLEN WRENCH (4mm)		1PC

ITEM: 708358



ASSEMBLY INSTRUCTIONS

STEP 1 Do not tighten until each step is completed or instructed.

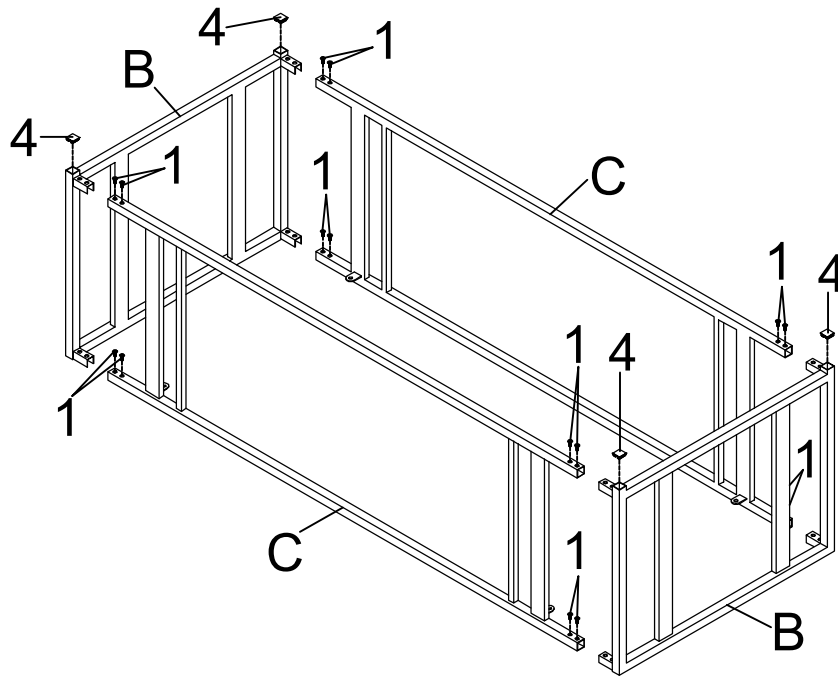

STEP 2

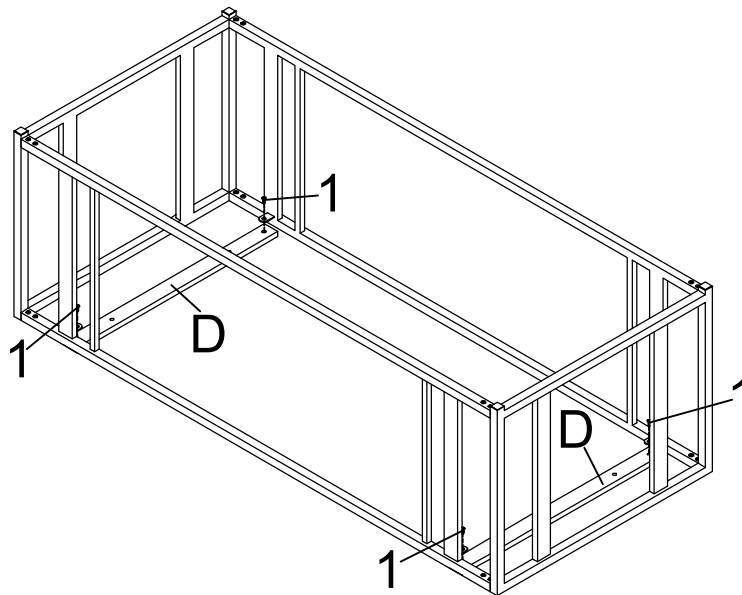

ITEM: 708358

ASSEMBLY INSTRUCTIONS

STEP 3

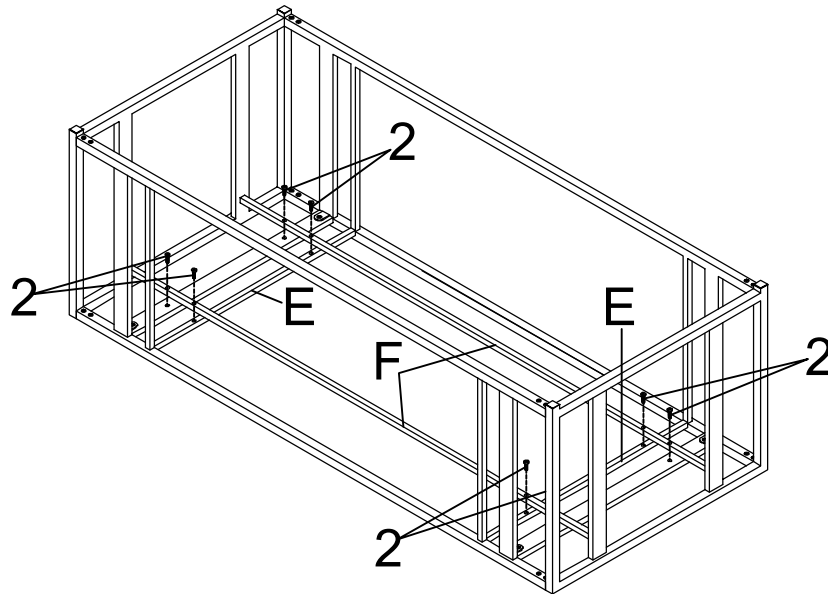

STEP 4

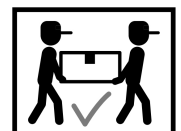
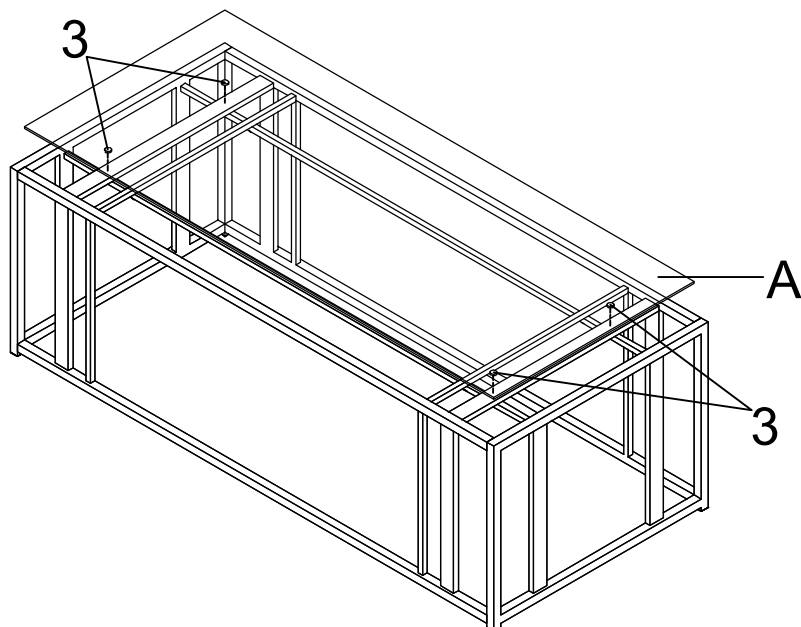

ITEM: 708358 ASSEMBLY INSTRUCTIONS



Product Size : 1372 X 610 X 457 H (MM)
Product Size : 54" X 24" X 18"

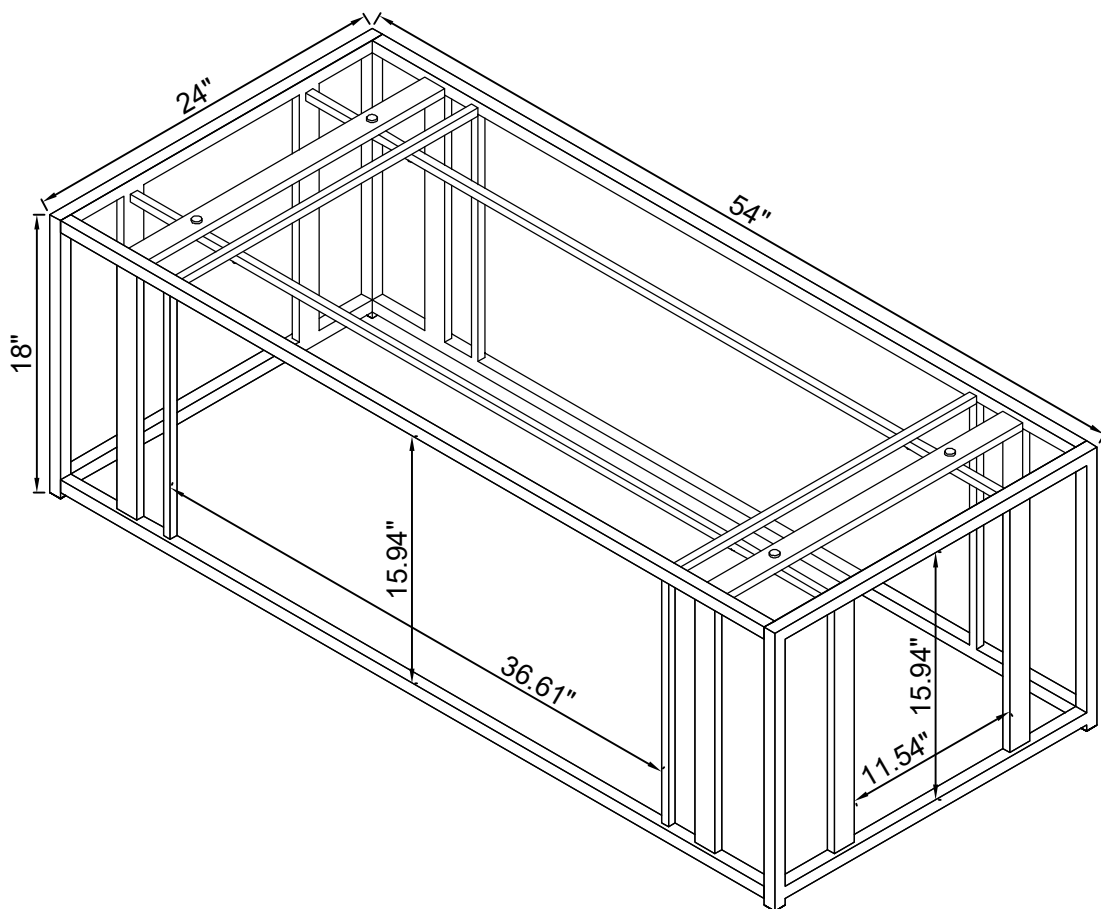

Note : Dimension tolerance $\pm 5\%$