

ASSEMBLY INSTRUCTIONS COASTER FINE FURNITURE



Fine Furniture for every stage of life

702288
COFFEE TABLE

ITEM: 702288

ASSEMBLY INSTRUCTIONS



ASSEMBLY TIPS:

1. Remove hardware from box and sort by size.
2. Please check to see that all hardware and parts are present prior to start of assembly.
3. Please follow attached instructions in the same sequence as numbered to assure fast & easy assembly.



WARNING !

1. Don't attempt to repair or modify parts that are broken or defective. Please contact the store immediately.
2. This product is for home use only and not intended for commercial establishment.

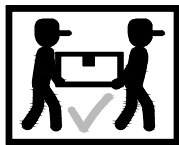

ASSEMBLY TIME 30 MINUTES

PARTS IDENTIFICATION

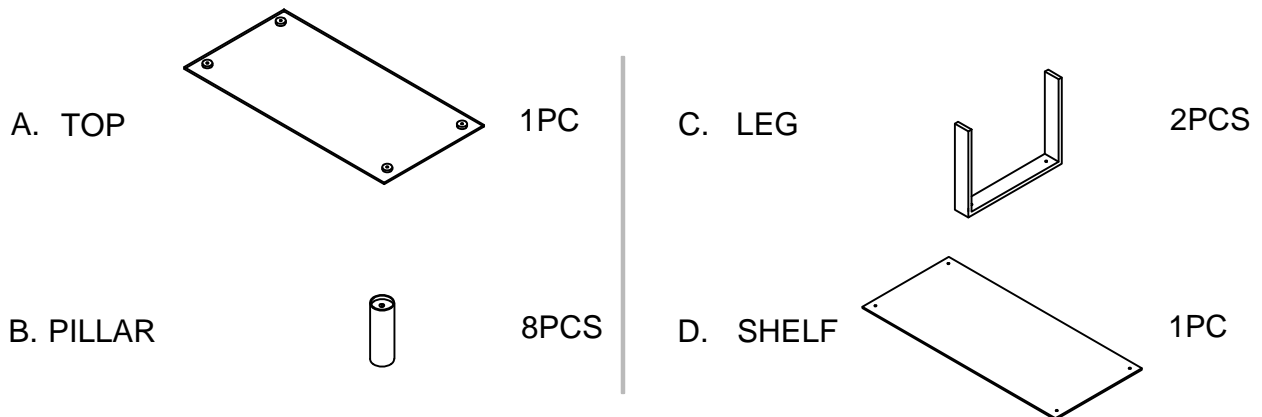

HARDWARE PACKAGE

1	SCREW (Ø5/16" *35mm-CHROME)		4PCS	5	FLAT WASHER (Ø5/16" *20mm-CHROME)		4PCS
2	STUD BOLT (Ø5/16" *(10+65mm)-CHROME)		4PCS	6	ALLEN BOLT (Ø5/16" *35mm-CHROME)		4PCS
3	CHROMED WASHER (Ø5/16" *55mm-CHROME)		8PCS	7	SMALL WASHER (Ø5/16" *25mm-CHROME)		4PCS
4	BIG WASHER (Ø5/16" *50mm-CHROME)		4PCS	8	ALLEN WRENCH (Ø5/16" *66mm-CHROME)		1PC

ITEM: 702288

ASSEMBLY INSTRUCTIONS



STEP 1

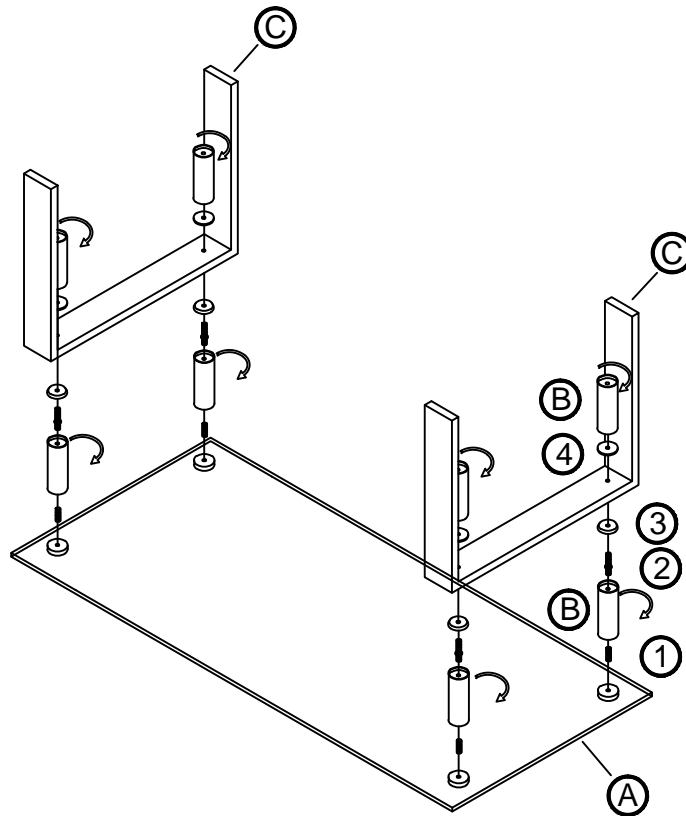

STEP 2

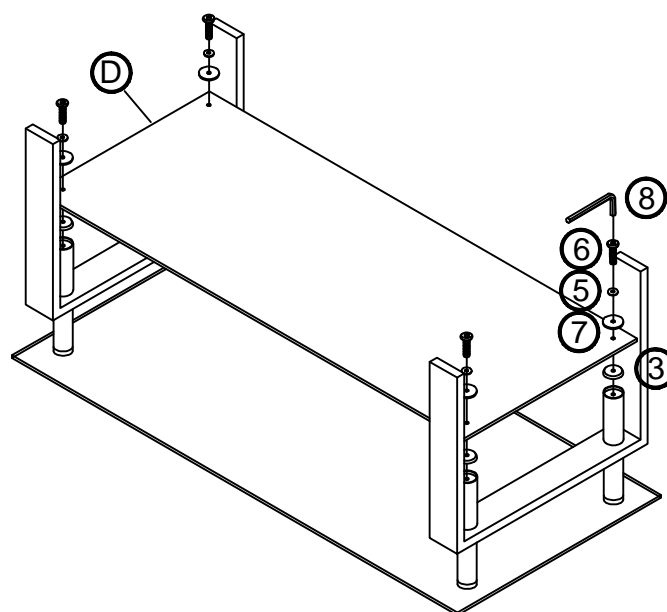

ITEM: 702288

ASSEMBLY INSTRUCTIONS



STEP 3
COMPLETE

