

ASSEMBLY INSTRUCTIONS
COASTER FINE FURNITURE



Fine Furniture for every stage of life

180079
Bar Stool

ITEM: 180079



ASSEMBLY INSTRUCTIONS

ASSEMBLY TIPS:

1. Remove hardware from box and sort by size.
2. Please check to see that all hardware and parts are present prior to start of assembly.
3. Please follow attached instructions in the same sequence as numbered to assure fast & easy assembly.



WARNING!



1. Don't attempt to repair or modify parts that are broken or defective. Please contact the store immediately.
2. This product is for home use only and not intended for commercial establishments.





ASSEMBLY TIME

10 MINUTES

PARTS IDENTIFICATION

AV	LEG FRAME		2PCS
BV	WOODEN SEAT		1PC
CV	STRETCHER		2PCS

HARDWARE IDENTIFICATION

1	HEX HEAD SCREW (Φ1/4" x 30mm - GD)		8PCS
2	ALLEN WRENCH (4MM - GD)		1PC
3	WOOD PLUG (Φ13mm - SR)		8PCS

NOTE:

Quantities shown are for one stool.

ITEM:180079



ASSEMBLY INSTRUCTIONS

STEP 1

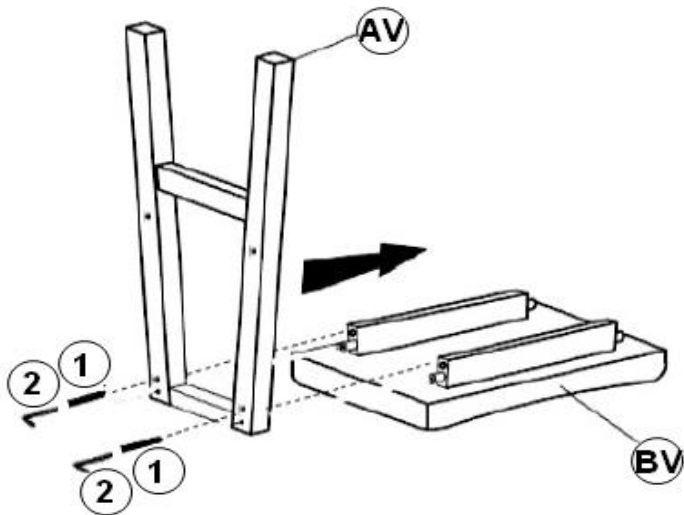

STEP 2

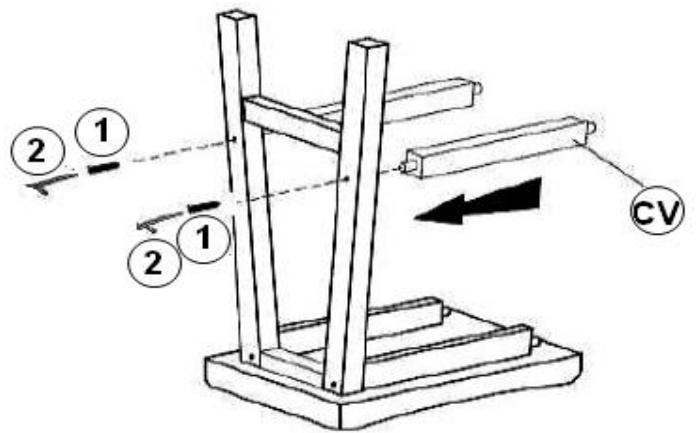

STEP 3

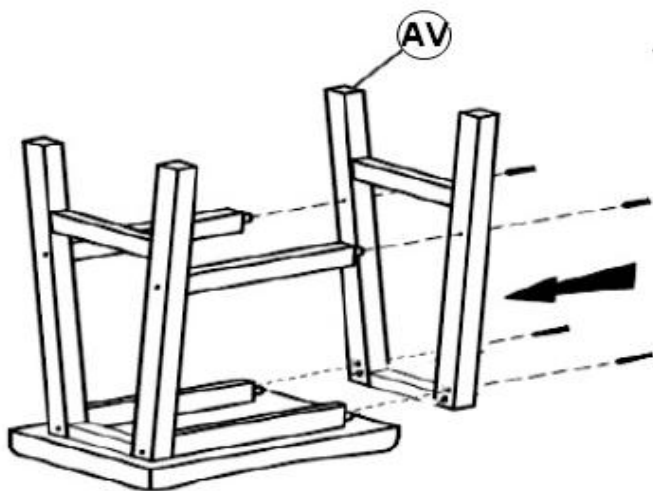

STEP 4

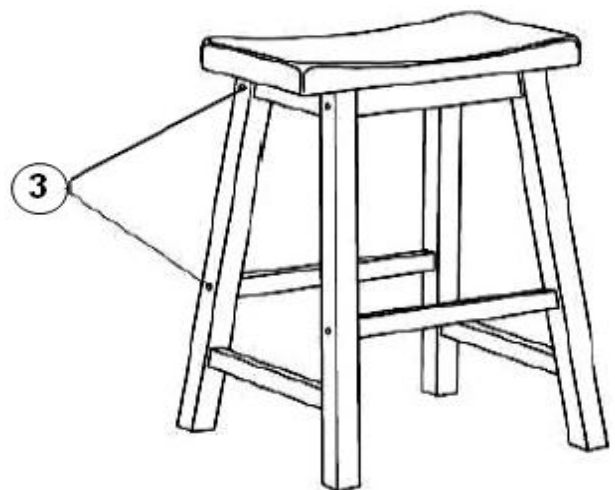

STEP 5
COMPLETE



ITEM:180079

COASTER
FINE FURNITURE

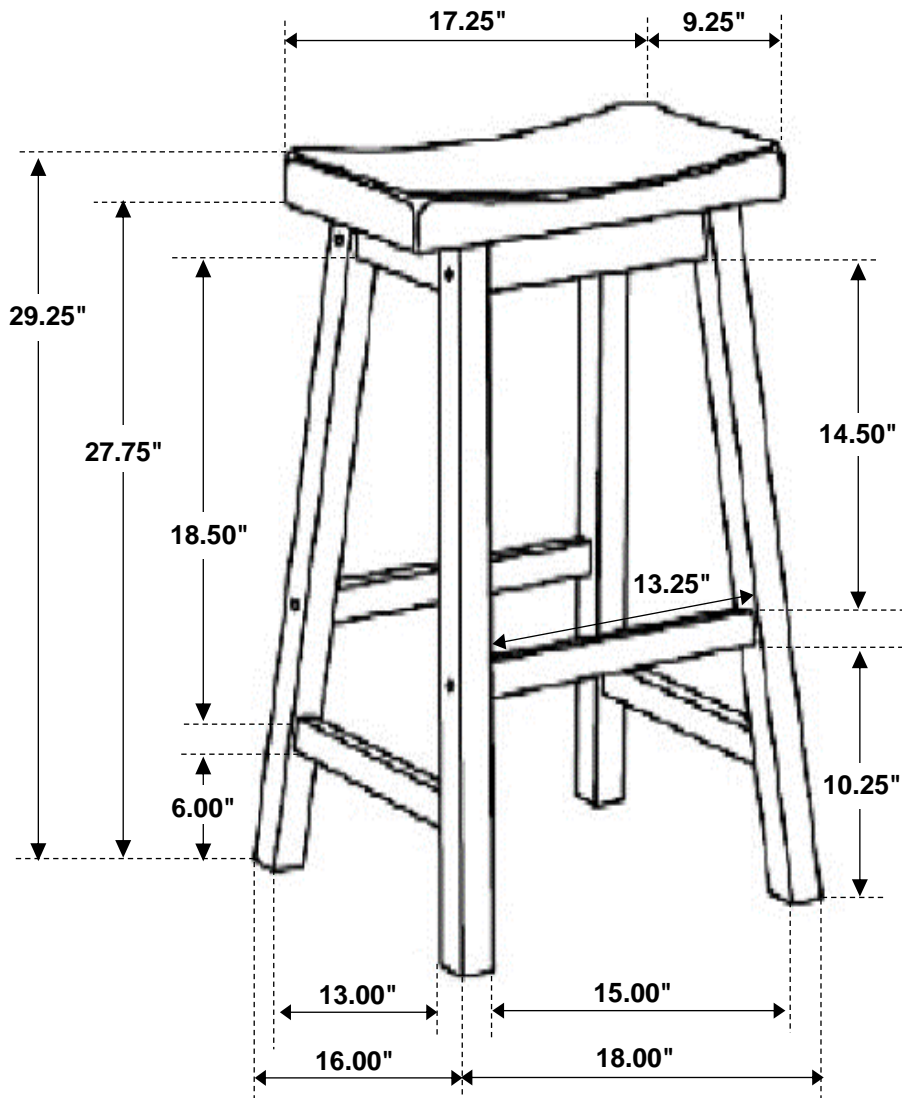

Note: Dimension tolerance $\pm 5\%$