



ASSEMBLY INSTRUCTIONS
COASTER FINE FURNITURE



Fine Furniture for every stage of life

104965
BARSTOOL

REVISION 0 : 06/16/2020
REVISION 1 : 09/15/2020
REVISION 2 : 08/01/2022

PAGE 1 OF 3

COASTERFURNITURE.COM

ITEM :104965

ASSEMBLY INSTRUCTIONS



ASSEMBLY TIPS:

1. Remove hardware from box and sort by size.
2. Please check to see that all hardware and parts are present prior to start of assembly.
3. Please follow attached instructions in the same sequence as numbered to assure fast & easy assembly.



Warning!

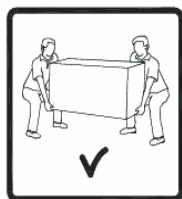

1. Don't attempt to repair or modify parts that are broken or defective. Please contact the store immediately.

2. This product is for home use only and not intended for commercial establishments.



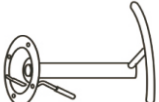
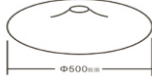
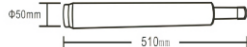

ASSEMBLY TIME	5 MINUTES
---------------	-----------

PARTS IDENTIFICATION

	PART NAME	FIGURE	QTY
A	SEAT		1PC
B	FOOTREST		1PC
C	BASE		1PC
D	GAS CYLINDER		1PC
E	COVER RING		1PC

HARDWARE IDENTIFICATION

	HARDWARE NAME	FIGURE	QTY
1	BOLTS M6x16MM		4PCS
2	ALLEN WRENCH M5		1PC

ITEM : 104965 ASSEMBLY INSTRUCTIONS

STEP 1

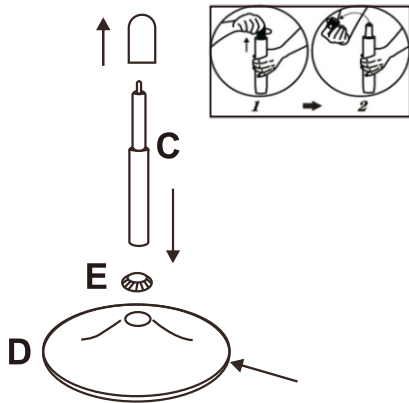

Place the chair seat (A) upside down on a soft surface. Then attach the foot rest (B) to the chair seat (A) using the bolt (1) and tighten with the allen wrench (2).

STEP 2

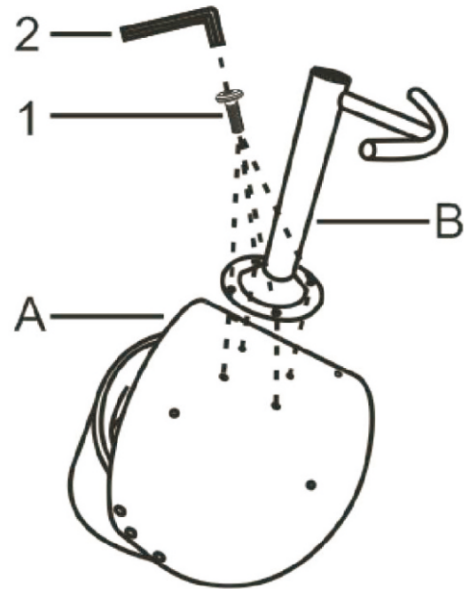

STEP 3

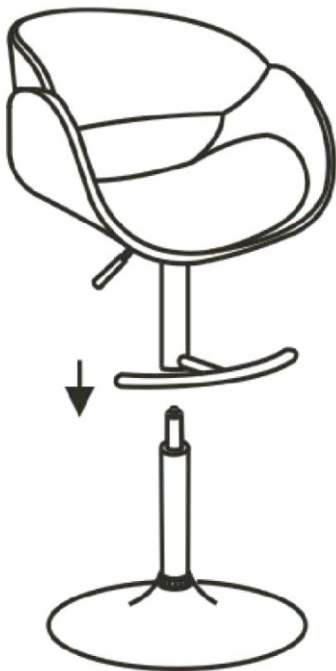

STEP 4



ITEM :104965
ASSEMBLY INSTRUCTIONS

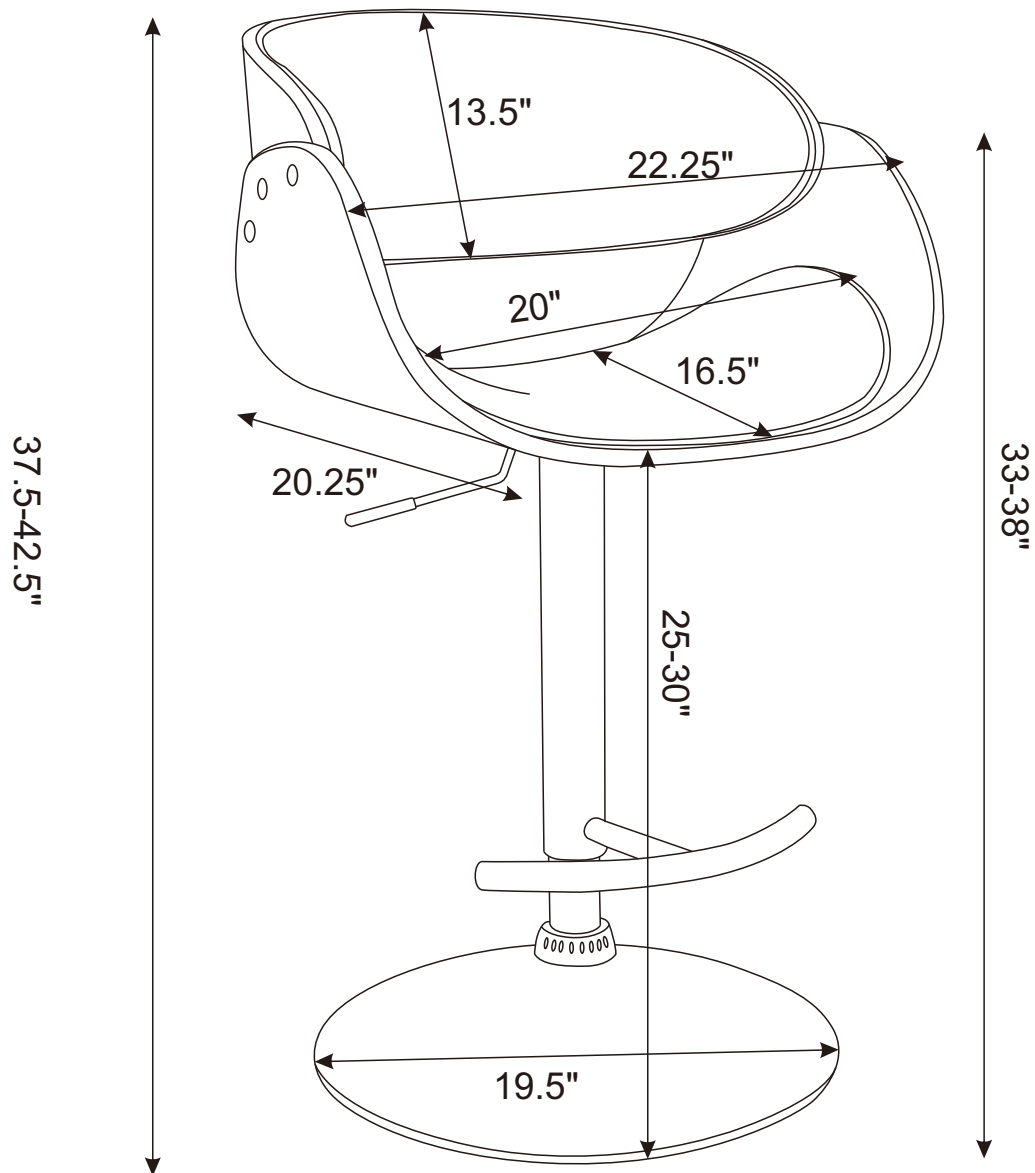

Note:Dimension tolerance±5%