

ASSEMBLY INSTRUCTIONS
COASTER FINE FURNITURE

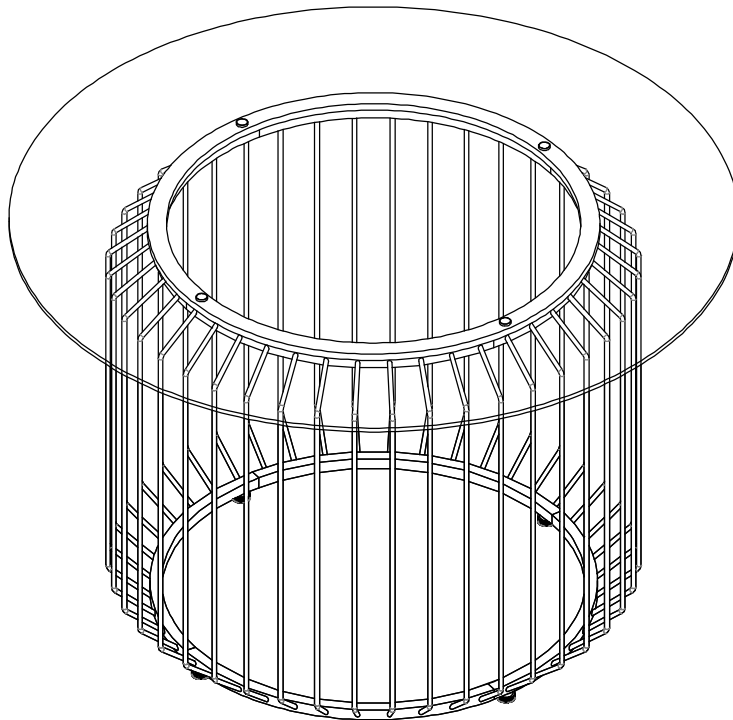

Fine Furniture for every stage of life

193430
DINING TABLE BASE

REVISION 0 : 12/29/2020
REVISION 1 : 07/26/2023

ITEM:193430

ASSEMBLY INSTRUCTIONS



ASSEMBLY TIPS:

1. Remove hardware from box and sort by size.
2. Please check to see that all hardware and parts are present prior to start of assembly.
3. Please follow attached instructions in the same sequence as numbered to assure fast & easy assembly.



WARNING!

1. Don't attempt to repair or modify parts that are broken or defective. Please contact the store immediately.
2. This product is for home use only and not intended for commercial establishments.

ASSEMBLY TIME 30 MINUTES

PARTS IDENTIFICATION

A GLASS

GLASS SOLD SEPARATELY.

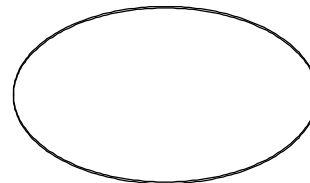

1PC

B TOP FRAME

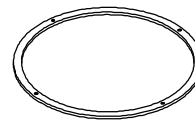

1PC

C BASE FRAME



4PCS

HARDWARE IDENTIFICATION

1	BOLT (1/4" x 12mm SR)		12PCS
2	SUCTION CUP		4PCS
3	LEVELER (1/4" x 12mm SR)		4PCS
4	ALLEN KEY (4mm)		1PC

ITEM:193430 ASSEMBLY INSTRUCTIONS



STEP 1 Do not tighten until each step is completed or instructed.

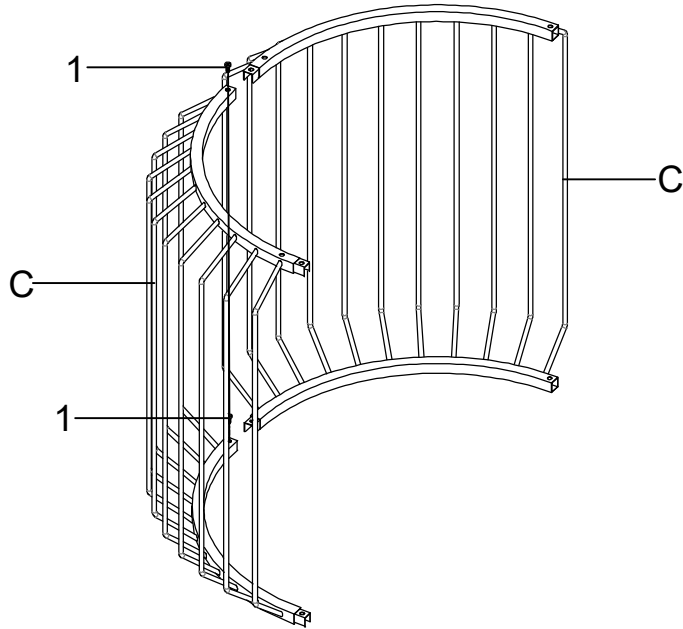

STEP 2

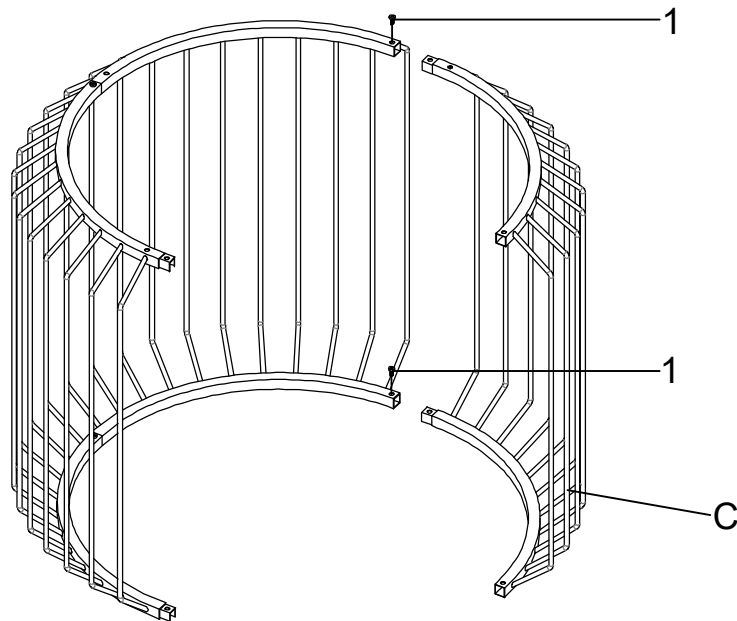

ITEM: 193430
ASSEMBLY INSTRUCTIONS
STEP 3

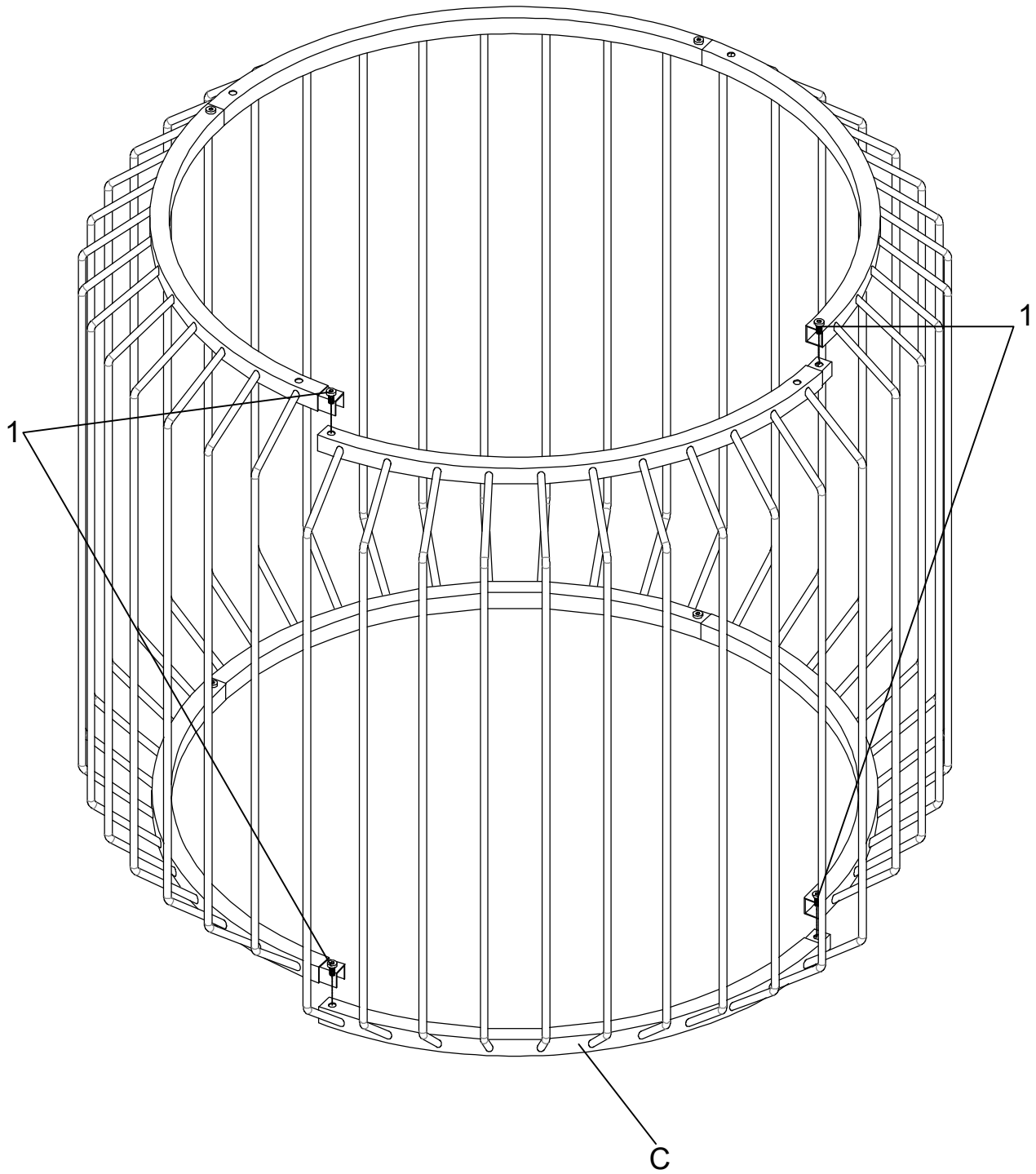

ITEM: 193430
ASSEMBLY INSTRUCTIONS
STEP 4

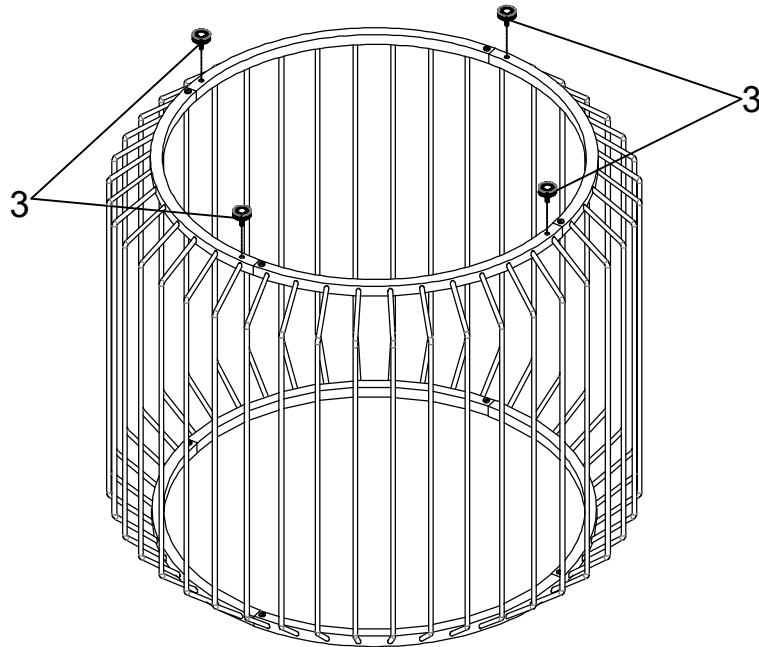

STEP 5

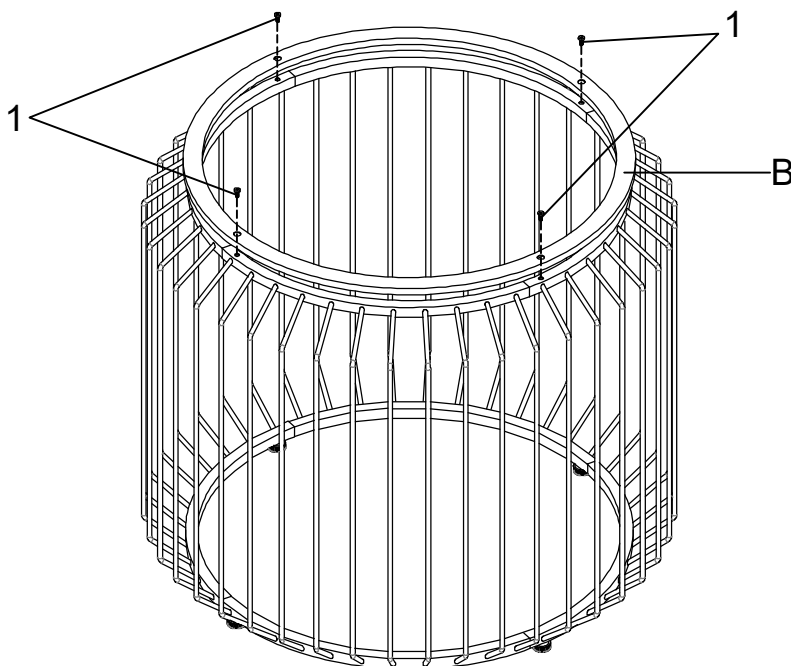

ITEM:193430
ASSEMBLY INSTRUCTIONS



STEP 6 *GLASS SOLD SEPARATELY.*

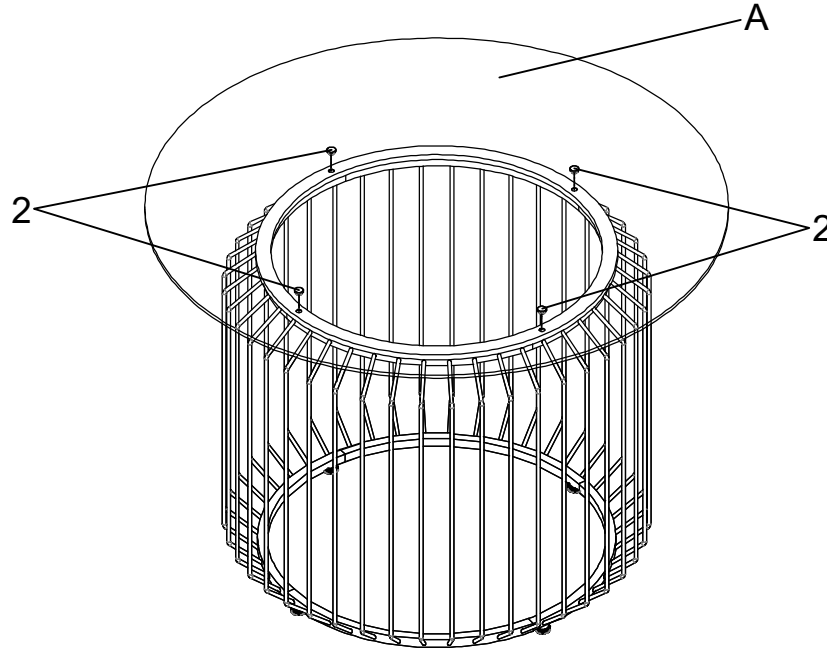

STEP 7 *GLASS SOLD SEPARATELY.*

COMPLETE

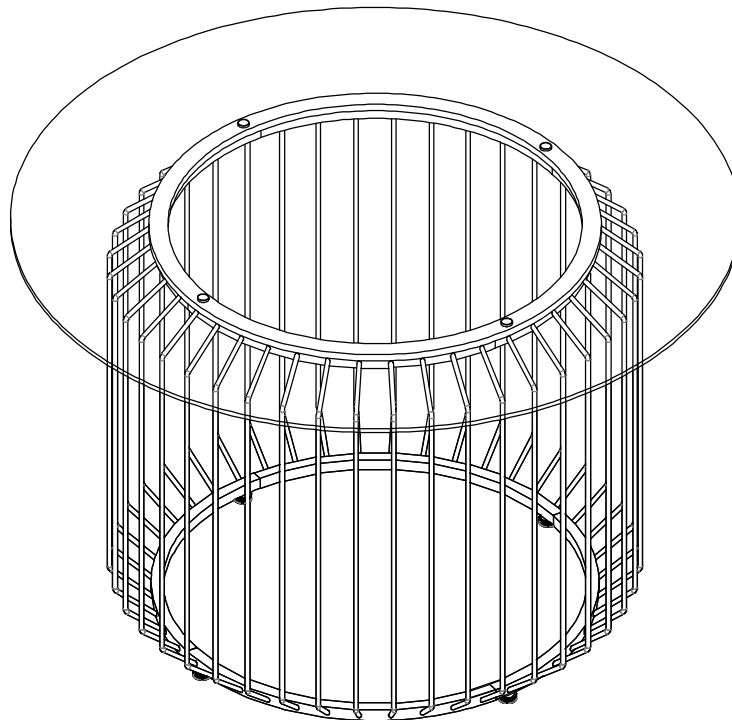

ITEM:193430 ASSEMBLY INSTRUCTIONS



Product Size : 889 DIA X 743 H (MM)

Product Size : 35" DIA X 29.25"

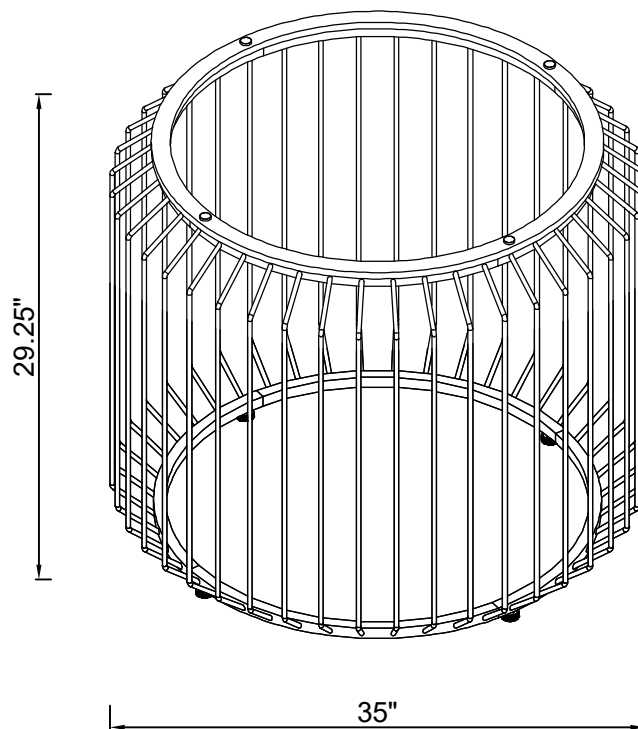

Note : Dimension tolerance $\pm 5\%$