



ASSEMBLY INSTRUCTIONS COASTER FINE FURNITURE



110272
DINING CHAIR

REVISION 0:04/21/2021
REVISION 1:05/25/2021
REVISION 2:08/23/2022
REVISION 3:02/16/2023

PAGE 1 OF 4

COASTERFURNITURE.COM

ITEM:110272



ASSEMBLY INSTRUCTIONS

ASSEMBLY TIPS:

1. Remove hardware from box and sort by size.
2. Please check to see that all hardware and parts are present prior to start of assembly.
3. Please follow attached instructions in the same sequence as numbered to assure fast & easy assembly.



WARNING!

1. Don't attempt to repair or modify parts that are broken or defective. Please contact the store immediately.
2. This product is for home use only and not intended for commercial establishments.

ASSEMBLY TIME

5 MINUTES

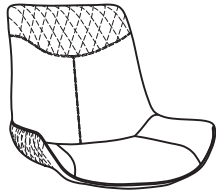

A SEAT AND BACK 1PC

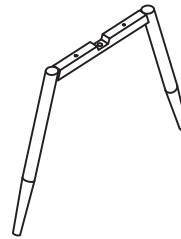

C LOWER LEG 1PC

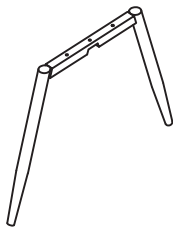



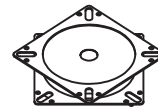

B UPPER LEG 1PC



D SWIVEL 1PC

HARDWARE IDENTIFICATION

Z	HARDWARE NAME	FIGURE	QTY
1	BOLT	 M6*16	6PCS
2	FLAT WASHER	 6* 18	9PCS
3	BOLT	 M6*25	3PCS
4	ALLEN WRENCH	 M5	1PC

ITEM:110272

ASSEMBLY INSTRUCTIONS

STEP 1

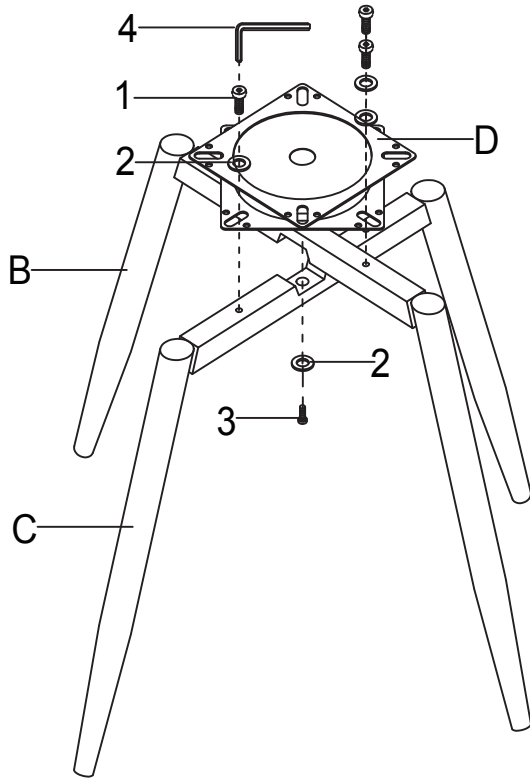

STEP 2

