

ASSEMBLY INSTRUCTIONS
COASTER FINE FURNITURE

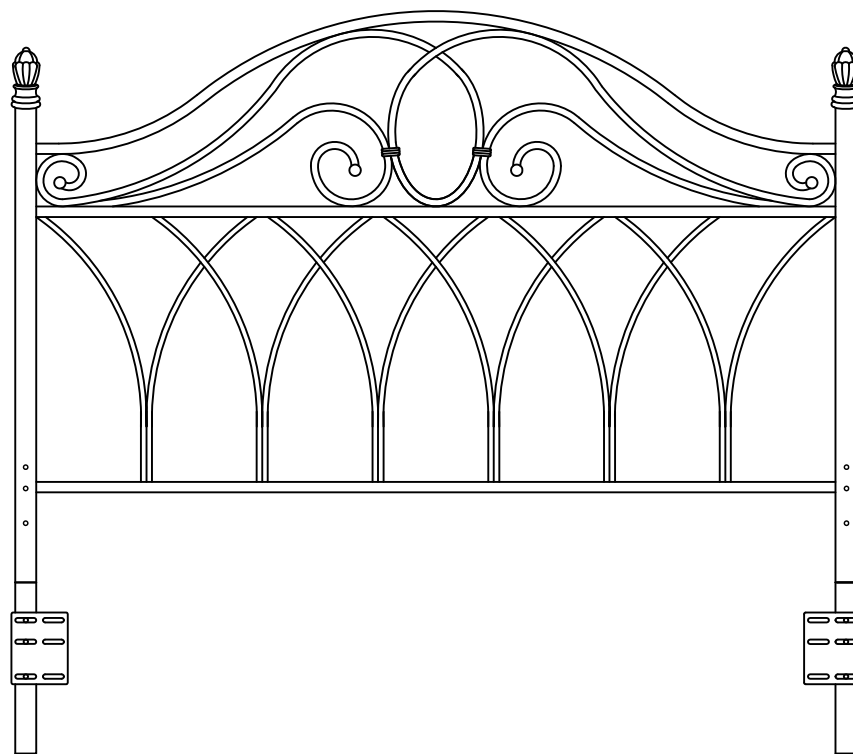

Fine Furniture for every stage of life

300186QF
Queen / Full Headboard

ITEM:300186QF



ASSEMBLY INSTRUCTIONS

ASSEMBLY TIPS:

1. Remove hardware from box and sort by size.
2. Please check to see that all hardware and parts are present prior to start of assembly.
3. Please follow attached instructions in the same sequence as numbered to assure fast & easy assembly.



WARNING !



1. Don't attempt to repair or modify parts that are broken or defective. Please contact the store immediately.
2. This product is for home use only and not intended for commercial establishment.







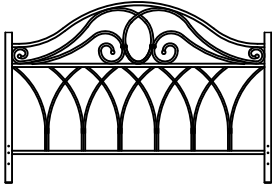
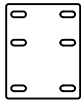



ASSEMBLY TIME

15 MINUTE

PARTS IDENTIFICATION

A HEADBOARD		1PC	C ADJUSTING PLATE		2PCS
B SUPPORT LEG		2PCS	D FINIAL		2PCS

HARDWARE IDENTIFICATION

1	BOLT (1/4"x2-1/4" - BLK)		4PCS	5	NUT (φ1/4"x11x8mm - BLK)		8PCS
2	BOLT (1/4"x7/8" - BLK)		4PCS	6	PLASTIC END CAP (φ1-1/2"mm - BLK)		2PCS
3	WASHER (φ16mm - BLK)		12PCS	7	ALLEN KEY (4x22X60mm - BLK)		1PC
4	WASHER (φ25mm - BLK)		8PCS	8	WRENCH (11.3x12.5X55mm - WHT)		1PC

NOTE:

Phillips head screw driver is required in the assembly process; however, manufacturer does not provide this item.

ITEM: **300186QF**



ASSEMBLY INSTRUCTIONS

ASSEMBLY

Do not fully tighten all bolts until assembly is complete.
This will help all parts to assemble properly.

STEP 1:

60" ASSEMBLY INSTRUCTIONS

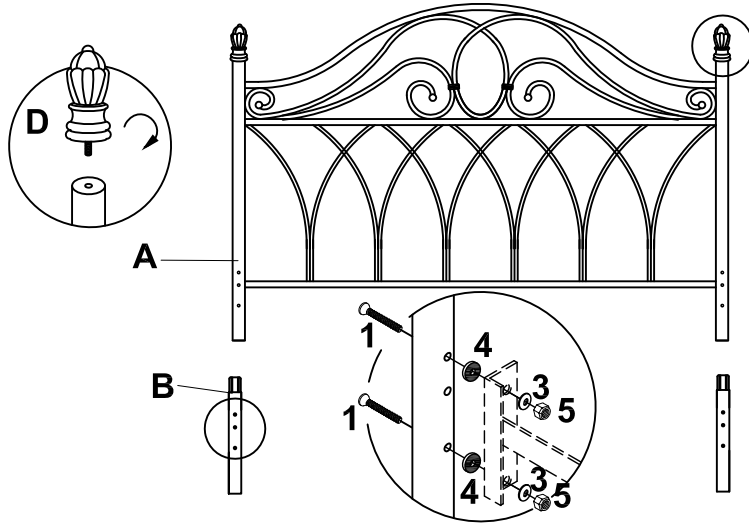

STEP 2:

54" ASSEMBLY INSTRUCTIONS

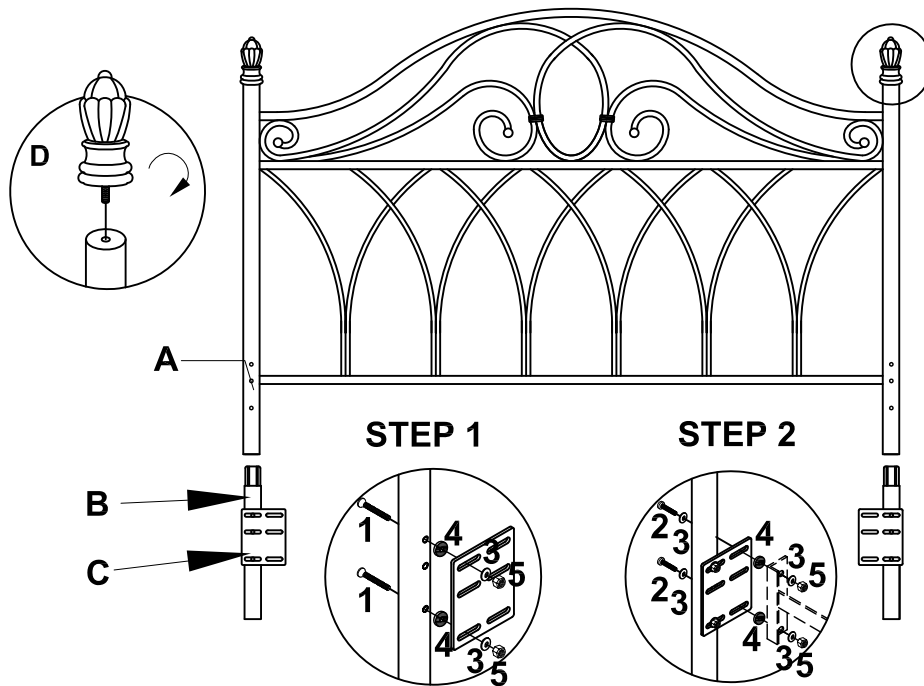

ITEM: **300186QF**

ASSEMBLY INSTRUCTIONS

STEP 3:

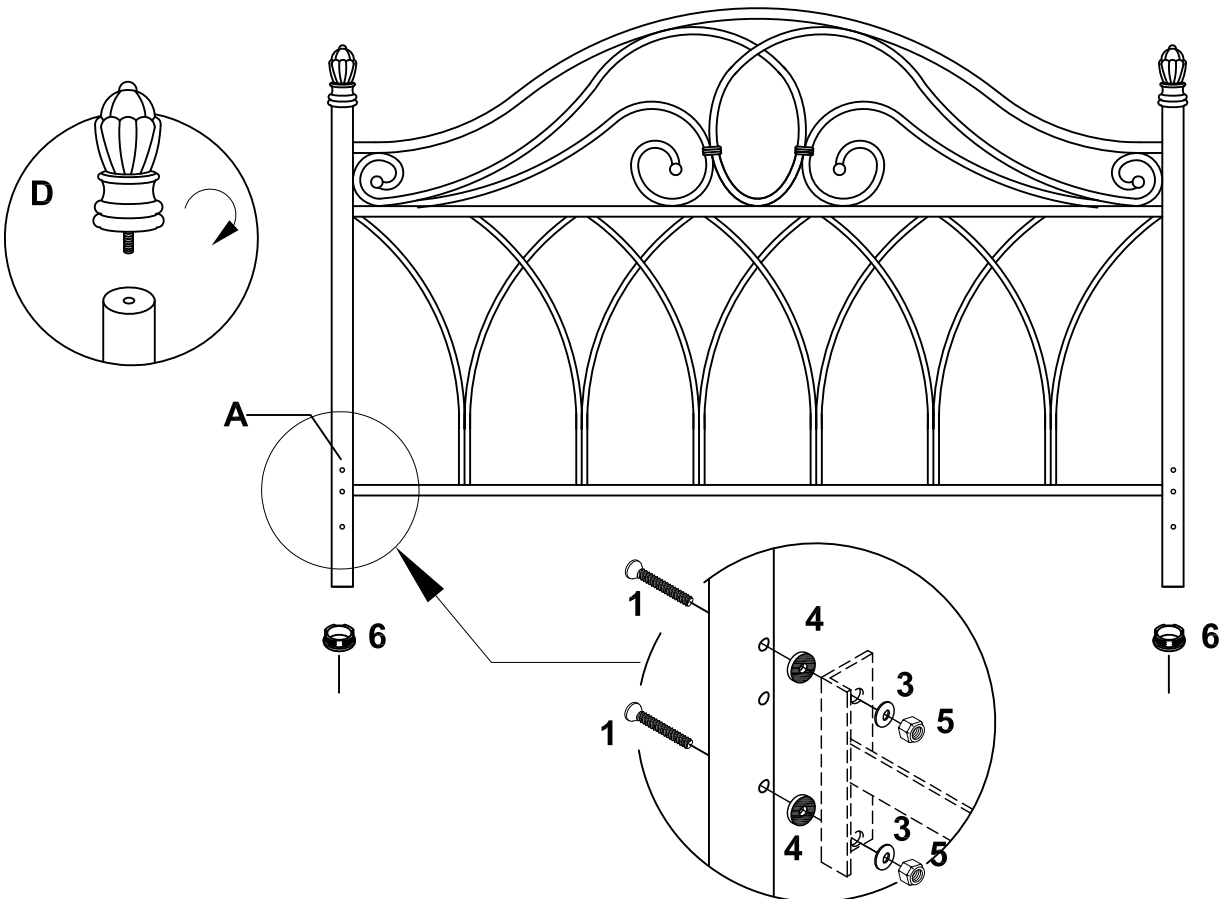

ITEM: **300186QF**

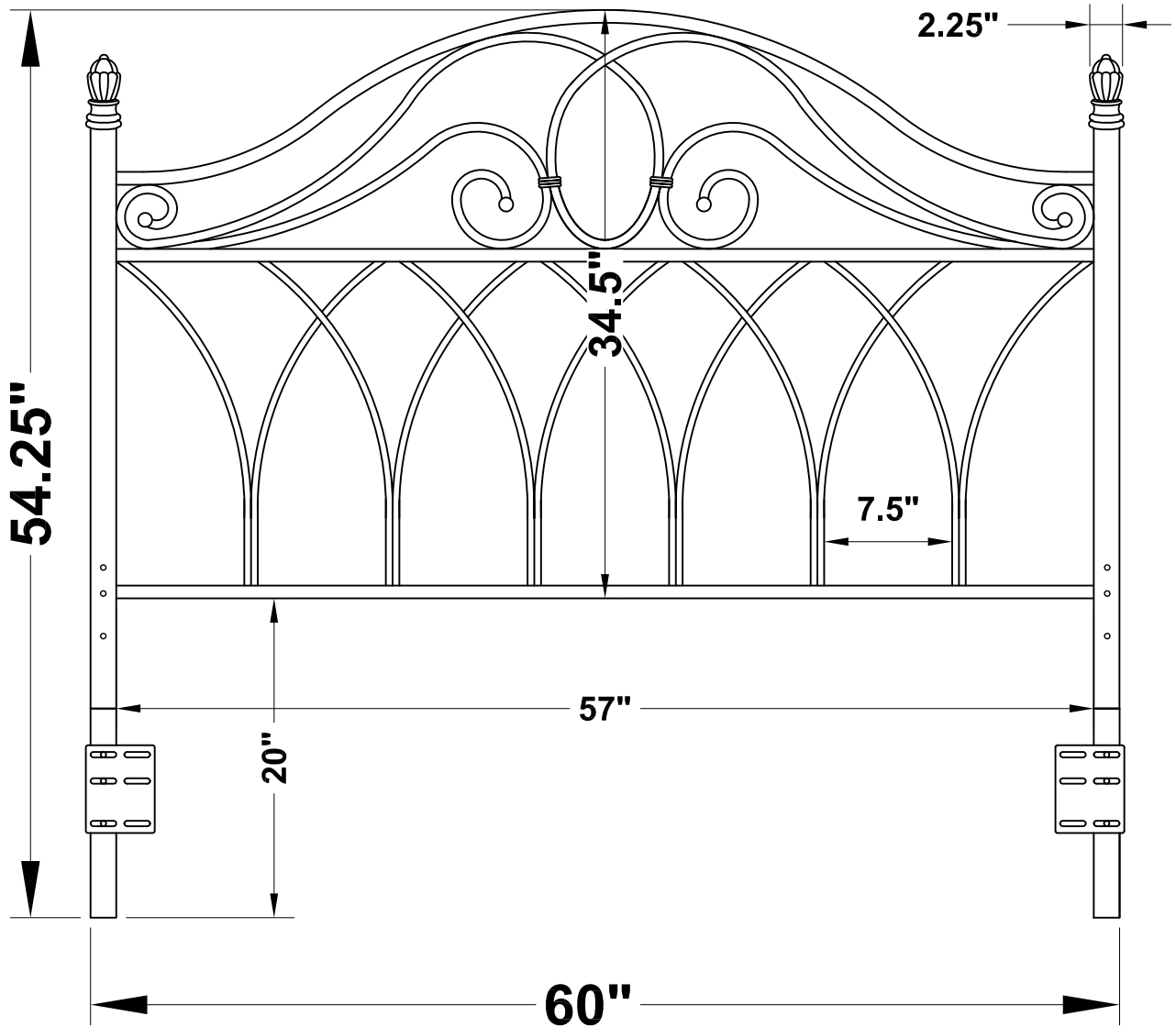

Note : Dimension tolerance $\pm 5\%$