

ASSEMBLY INSTRUCTIONS
COASTER FINE FURNITURE

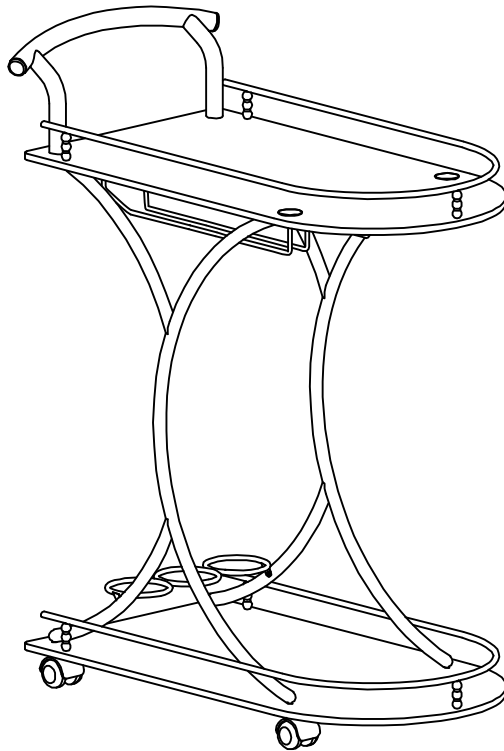

Fine Furniture for every stage of life

910002
SERVING CART

REVISION 0 : 11/10/2017
REVISION 1 : 09/02/2022

ITEM:910002



ASSEMBLY INSTRUCTIONS

ASSEMBLY TIPS:

1. Remove hardware from box and sort by size.
2. Please check to see that all hardware and parts are present prior to start of assembly.
3. Please follow attached instructions in the same sequence as numbered to assure fast & easy assembly.



WARNING!

1. Don't attempt to repair or modify parts that are broken or defective. Please contact the store immediately.
2. This product is for home use only and not intended for commercial establishments.

ASSEMBLY TIME 45 MINUTES

PARTS IDENTIFICATION

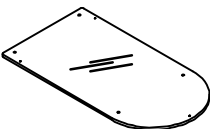
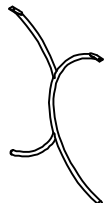
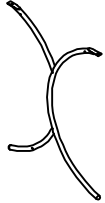
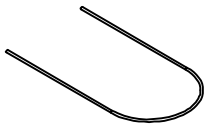
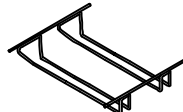
A	HAND RAIL		1PC
B	GLASS		2PCS
CL	LEFT SIDE FRAME		1PC
CR	RIGHT SIDE FRAME		1PC
D	U FRAME		2PCS
E	GLASS HOLDER		1PC

ITEM:910002

ASSEMBLY INSTRUCTIONS

PARTS IDENTIFICATION



F	BOTTLE HOLDER		1PC
G	CASTER		2CPS
H	CASTER WITH LOCK		2CPS

HARDWARE IDENTIFICATION

1	PLASTIC SPACER (ϕ 12 x 30mm)		6PCS	8	SMALL PLASTIC WASHER (ϕ 23mm)		12PCS
2	BOLT CAP (ϕ 35mm)		2PCS	9	CAP (ϕ 25mm)		2PCS
3	LONG CROSS HEAD BOLT (3/16" x 38mm)		6PCS	10	SHORT CROSS HEAD BOLT (3/16" x 12mm)		2PCS
4	SHORT BOLT (1/4" x 12mm SR)		2PCS	11	LARGE PLASTIC WAHER (ϕ 25 x 5mm)		2PCS
5	LARGE BOLT (1/4" x 38mm SR)		2PCS	12	ALLEN KEY (4mm)		1PC
6	SMALL WASHER (ϕ 12mm SR)		6PCS	13	HEXAGONAL KEY (8mm)		1PC
7	LARGE WASHER (ϕ 25mm SR)		4PCS				

ITEM:910002



ASSEMBLY INSTRUCTIONS

STEP 1 Do not tighten until each step is completed or instructed.

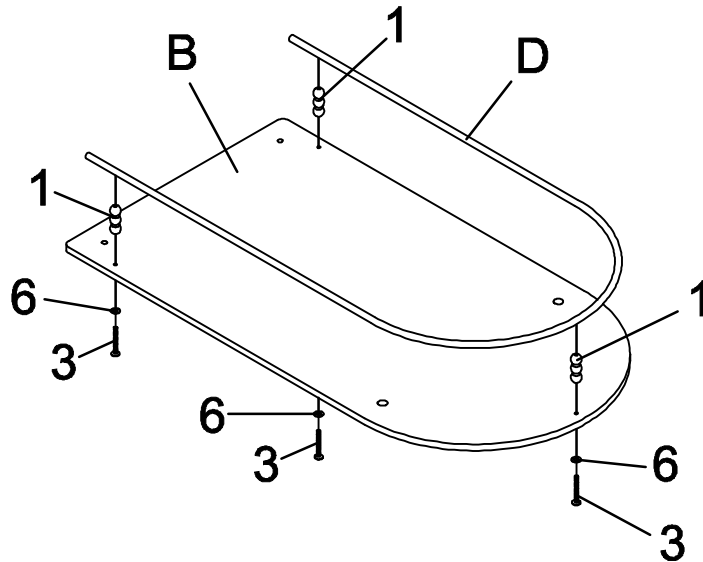

STEP 2

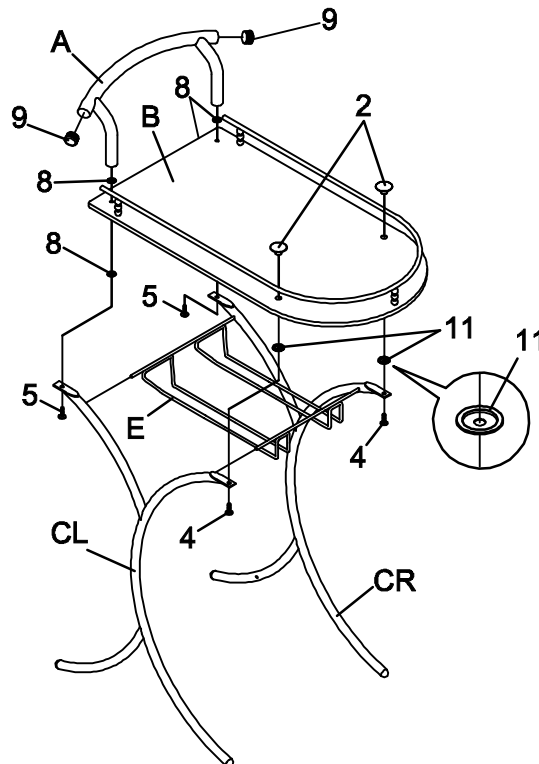

ITEM:910002

ASSEMBLY INSTRUCTIONS

STEP 3

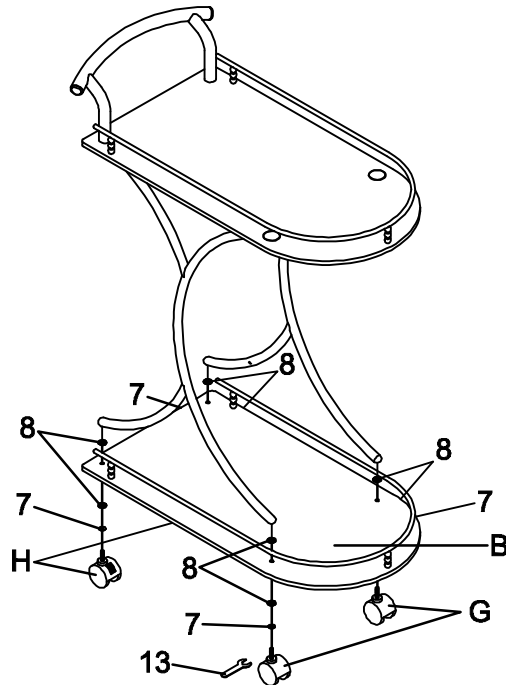

STEP 4 COMPLETE

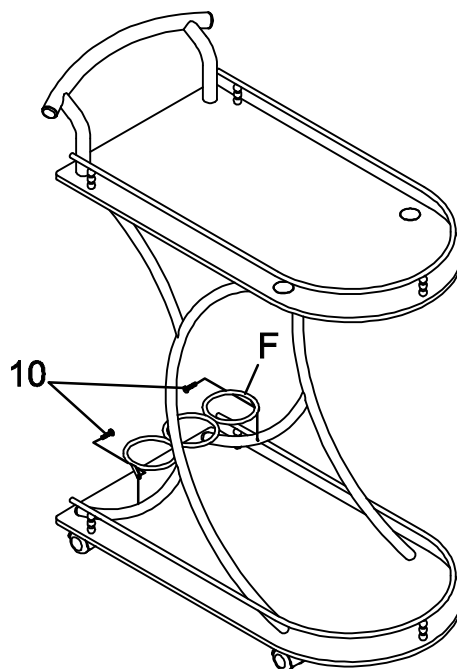

COMPLETE



ITEM:910002 ASSEMBLY INSTRUCTIONS



Product Size : 673 X 400 X 857 H (MM)

Product Size : 26 1/2" X 15 3/4" X 33 3/4"

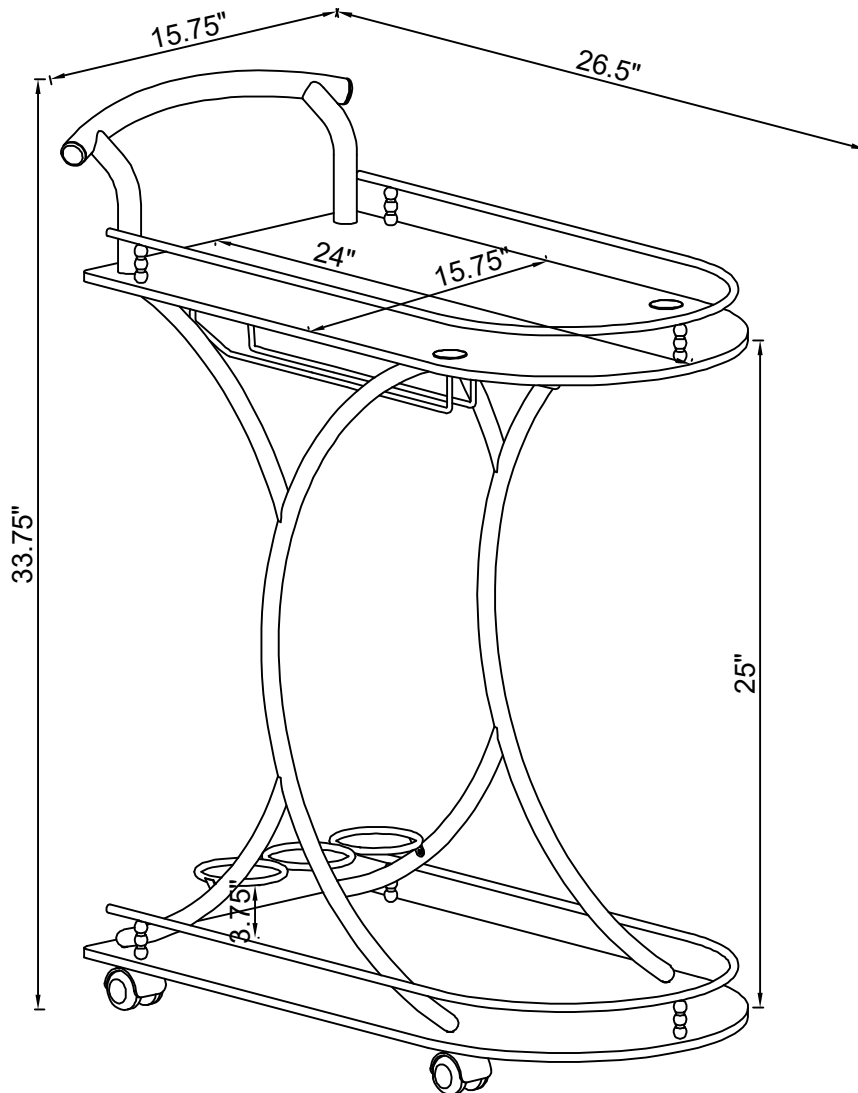

Note : Dimension tolerance $\pm 5\%$