

ASSEMBLY INSTRUCTIONS
COASTER FINE FURNITURE



Fine Furniture for every stage of life

108441
DINING TABLE

REVISION 0 : 06/08/2018
REVISION 1 : 08/25/2023

ITEM: 108441



ASSEMBLY INSTRUCTIONS

ASSEMBLY TIPS:

1. Remove hardware from box and sort by size.
2. Please check to see that all hardware and parts are present prior to start of assembly.
3. Please follow attached instructions in the same sequence as numbered to assure fast & easy assembly.



WARNING!

1. Don't attempt to repair or modify parts that are broken or defective. Please contact the store immediately.
2. This product is for home use only and not intended for commercial establishments.



ASSEMBLY TIME 30 MINUTES

PARTS IDENTIFICATION

B1: Top

A GLASS

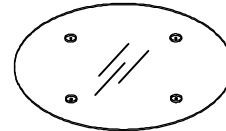

1PC

B2: Base

B LEG

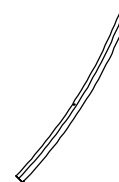

4PCS

HARDWARE IDENTIFICATION

1 SHORT BOLT
(5/16" x 10mm GD)



4PCS

2 LONG BOLT
(5/16" x 63mm GD)



4PCS

3 LEVELER
(5/16" x 18mm BLK)



4PCS

4 CAP
(25 x 50mm GD)



4PCS

5 WASHER
(Ø19mm SR)



4PCS

6 ALLEN WRENCH
(4mm)



1PC

HARDWARE PACK IS LOCATED IN 108441B2

PAGE 2 OF 5

COASTERFURNITURE.COM

ITEM:108441



ASSEMBLY INSTRUCTIONS

STEP 1 Do not tighten until each step is completed or instructed.

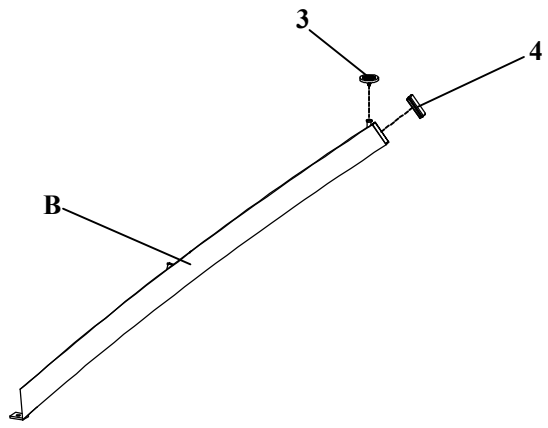

STEP 2

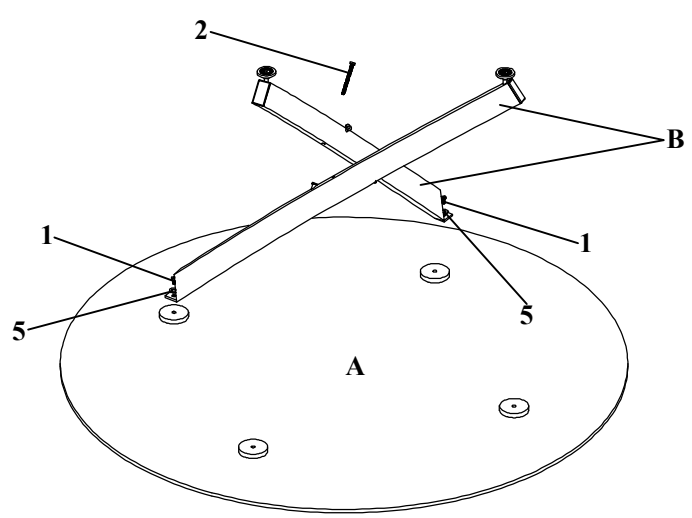

ITEM: 108441

ASSEMBLY INSTRUCTIONS

STEP 3

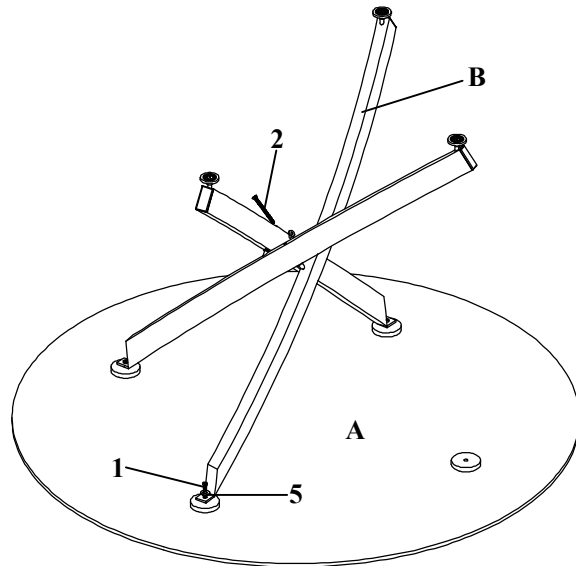

STEP 4

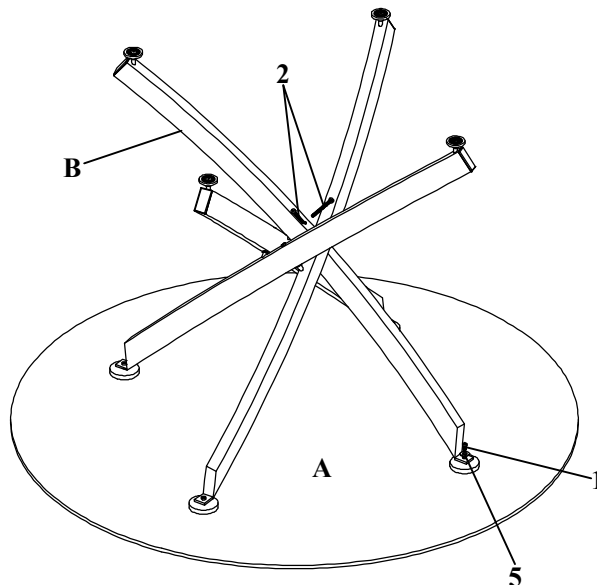

COMPLETE

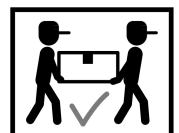
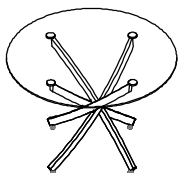

ITEM:108441 ASSEMBLY INSTRUCTIONS



Product Size : 1168 DIA X 750H (MM)
Product Size : 46" DIA X 29 1/2"

