



# ASSEMBLY INSTRUCTIONS COASTER FINE FURNITURE



*Fine Furniture for every stage of life*

## 205331KE (B1-B3) *Eastern King Bed*

REVISION 0 : 11/29/2016  
REVISION 1 : 12/13/2018  
REVISION 2 : 11/18/2019  
REVISION 3 : 08/07/2020

PAGE 1 OF 5

COASTERFURNITURE.COM

# ITEM: 205331KE(B1-B3)



## ASSEMBLY INSTRUCTIONS

### ASSEMBLY TIPS:

1. Remove hardware from box and sort by size.
2. Please check to see that all hardware and parts are present prior to start of assembly.
3. Please follow attached instructions in the same sequence as numbered to assure fast & easy assembly.



### WARNING!

1. Don't attempt to repair or modify parts that are broken or defective. Please contact the store immediately.
2. This product is for home use only and not intended for commercial establishments.

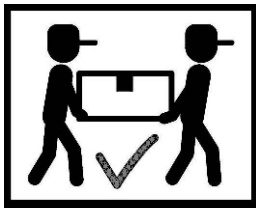

ASSEMBLY TIME

30 MINUTES

## PARTS IDENTIFICATION

### B1 (BOX 1)

A HEADBOARD PANEL

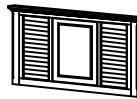

1PC

B LEFT HEADBOARD LEG



1PC

C RIGHT HEADBOARD LEG



1PC

### B2 (BOX 2)

D FOOTBOARD

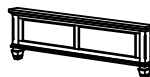

1PC

### B3 (BOX 3)

E BED RAIL



2PCS

FF BED SLAT



4PCS

G BED SLAT SUPPORT WITH LEVELER



8PCS

HB 205331KE (B1)  
FROM BOX 1  
HEADBOARD COMPLETE

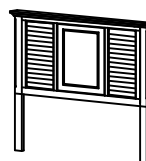

1PC

D 205331KE (B2)  
FROM BOX 2  
FOOTBOARD

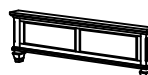

1PC

# ITEM: 205331KE(B1-B3)



## ASSEMBLY INSTRUCTIONS

### ASSEMBLY TIPS:

1. Remove hardware from box and sort by size.
2. Please check to see that all hardware and parts are present prior to start of assembly.
3. Please follow attached instructions in the same sequence as numbered to assure fast & easy assembly.





### WARNING!

1. Don't attempt to repair or modify parts that are broken or defective. Please contact the store immediately.
2. This product is for home use only and not intended for commercial establishments.

## HARDWARE IDENTIFICATION

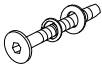
### Z-B3 (BOX 3) - HARDWARE PACK IS LOCATED IN 205331KE(B3)

1	<b>ALLEN WRENCH</b> (M4 - BLK)		1PC
2	<b>BOLT</b> (M6 x 50mm - BLK)		8PCS
3	<b>FLAT HEAD SCREW</b> (#8 x 1 1/8" - BLK)		8PCS

### NOTE:

Phillips head screw driver is required in the assembly process; however, manufacturer does not provide this item.

ITEM: **205331KE(B1-B3)**



**ASSEMBLY INSTRUCTIONS**

**STEP 1**

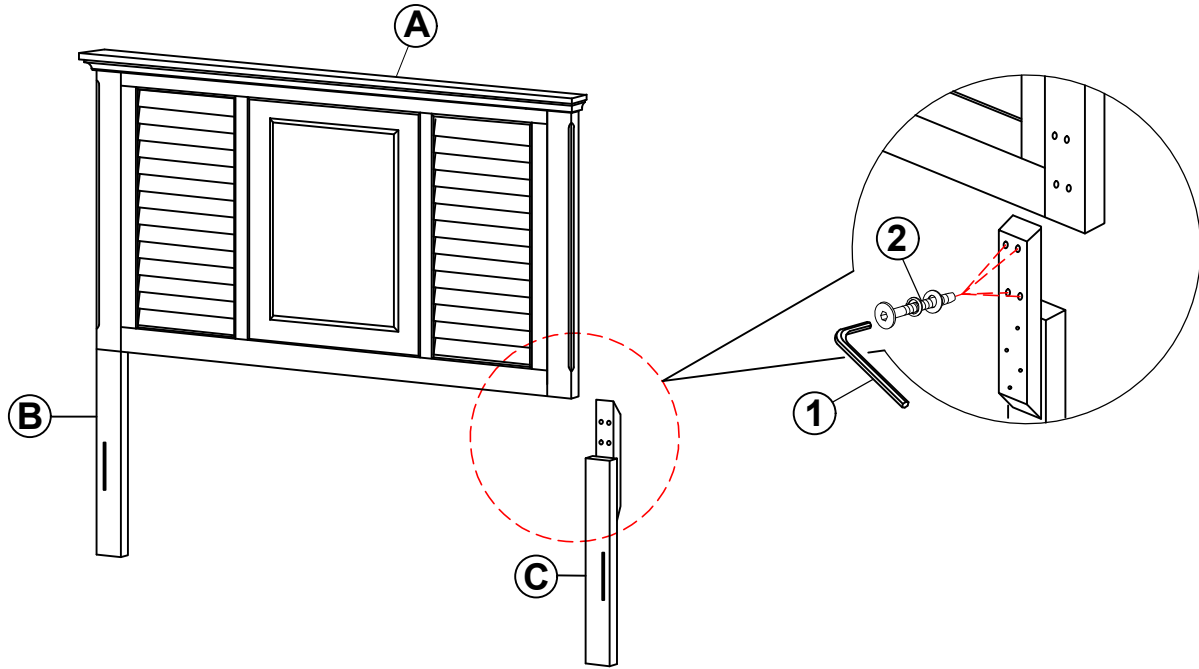

**STEP 2**

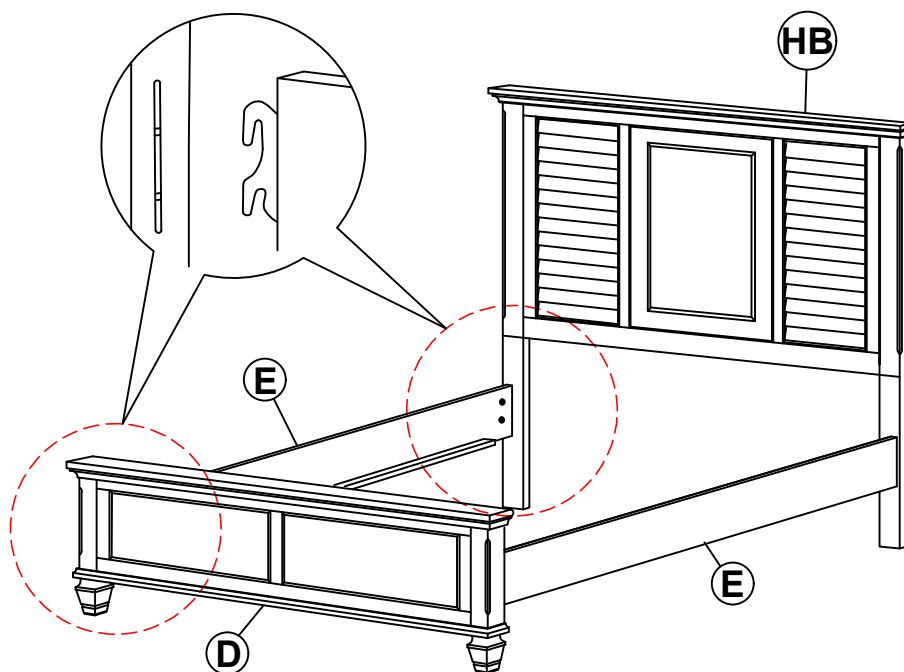

ITEM: **205331KE(B1-B3)**



**ASSEMBLY INSTRUCTIONS**

**STEP 3**

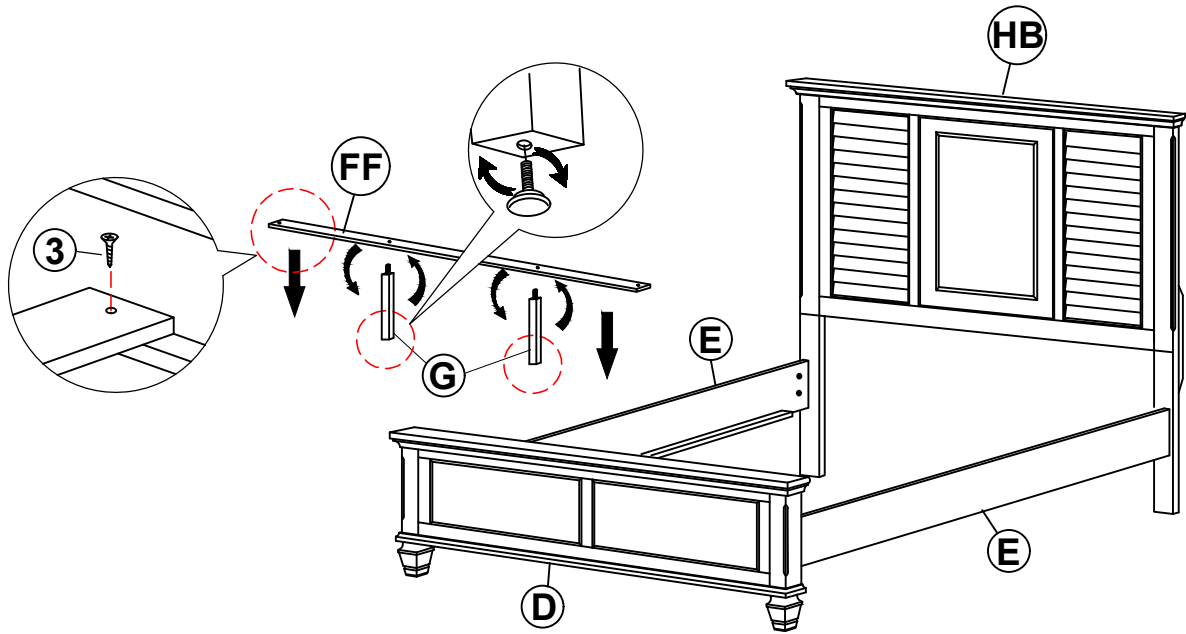

**STEP 4  
COMPLETE**

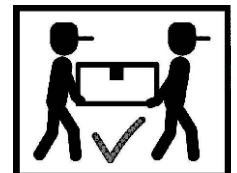
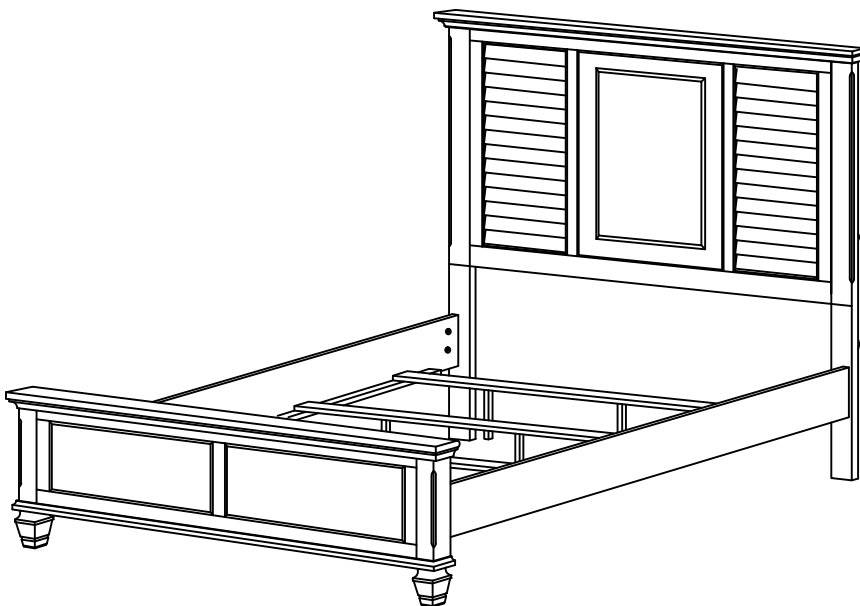

ITEM: **205331KE(B1-B3)**



Inner Size : 77.00"W X 81.00"D

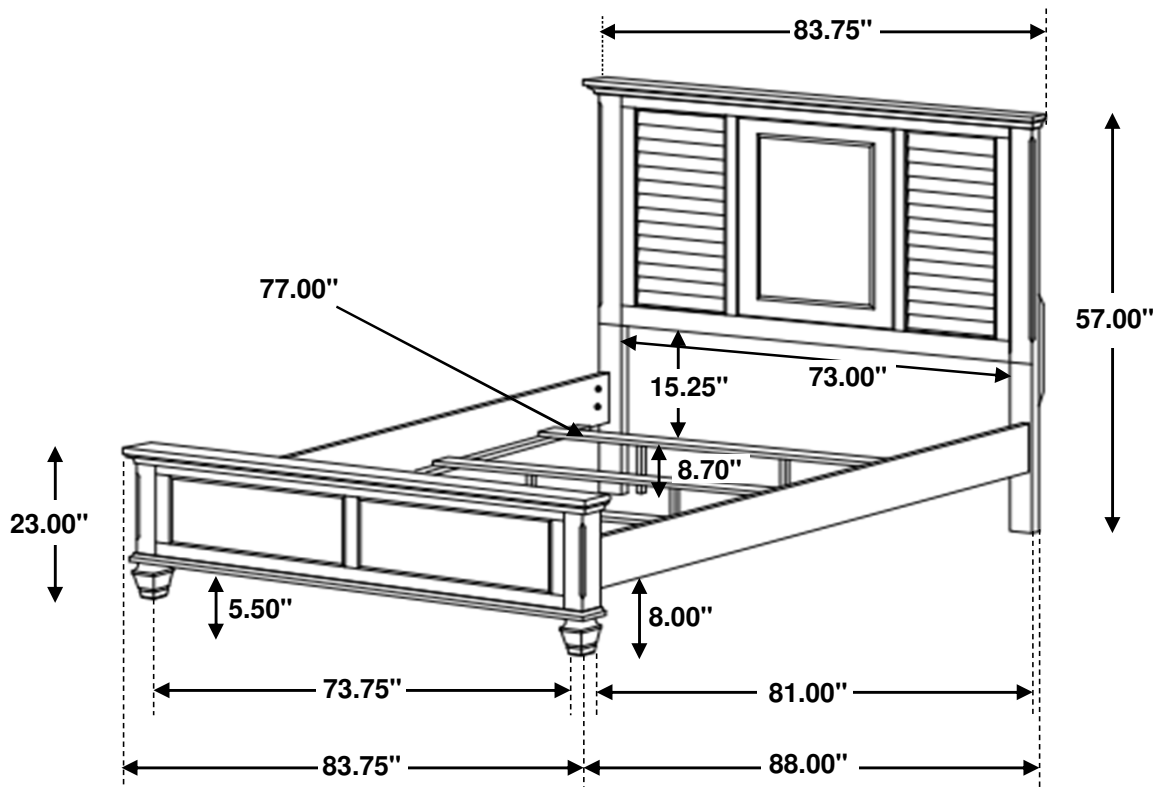

Note : Dimension tolerance  $\pm 5\%$