



ASSEMBLY INSTRUCTIONS
COASTER FINE FURNITURE



Fine Furniture for every stage of life

610265P
Power Loveseat

ITEM: 610265P

ASSEMBLY INSTRUCTIONS



ASSEMBLY TIPS:

- 1.Remove hardware from box and sort by size.
- 2.Please check to see that all hardware and parts are present prior to start of assembly.
- 3.Please follow attached instructions in the same sequence as numbered to assure fast & easy assembly.



WARNING







- 1.Don't attempt to repair or modify parts that are broken or defective. Please contact the store immediately.
- 2.This product is for home use only and not intended for commercial establishments.



ASSEMBLY TIME

5 MINUTES

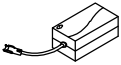
PARTS IDENTIFICATION

| | | | |
|---|--------------|---|-----|
| A | SEAT |  | 1PC |
| B | LEFT BACK |  | 1PC |
| C | CONSOLE BACK |  | 1PC |
| D | RIGHT BACK |  | 1PC |
| E | ADAPTER |  | 1PC |
| F | POWER CABLE |  | 1PC |

ITEM: **610265P**
ASSEMBLY INSTRUCTIONS



STEP 1

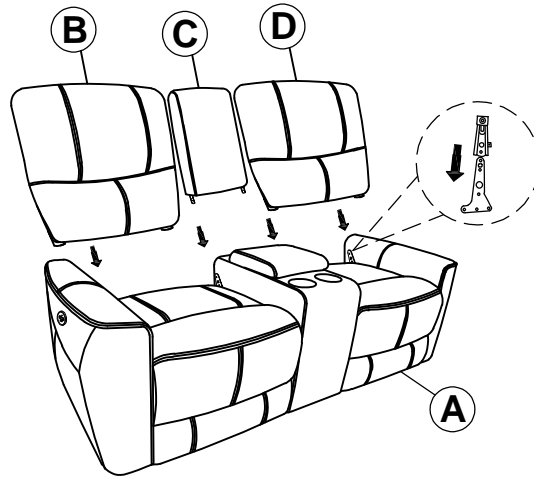

STEP 2

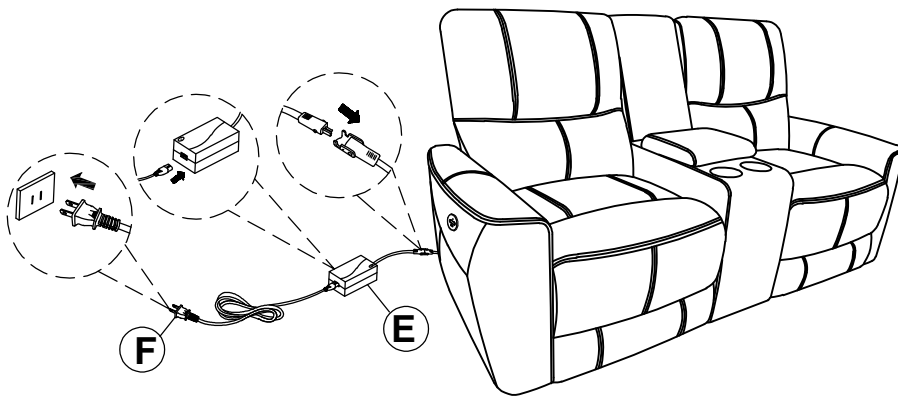

STEP 3
COMPLETE

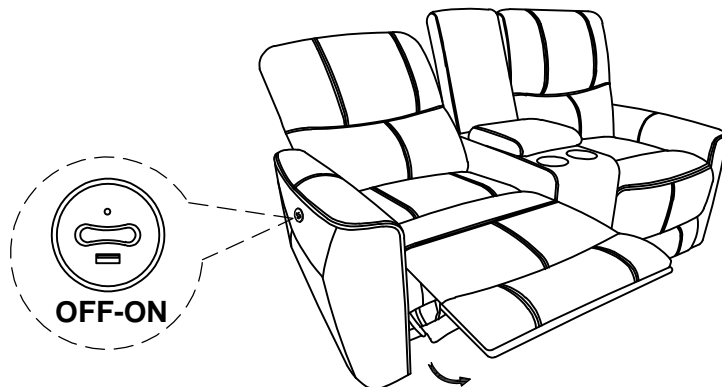

ITEM: 610265P

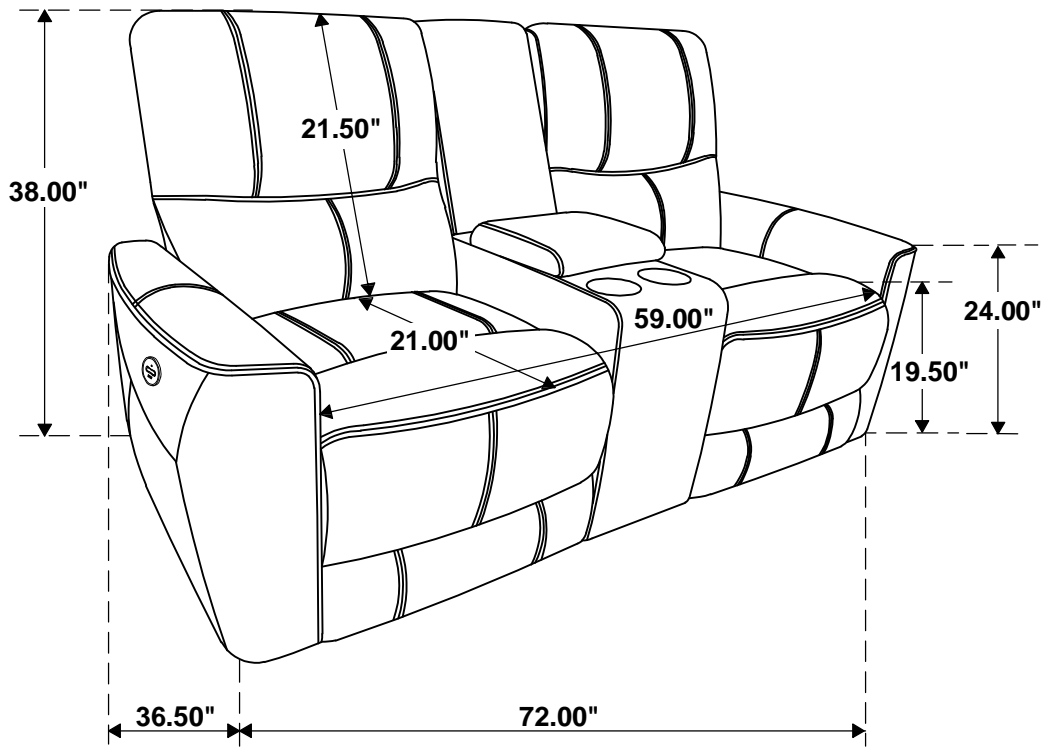

Note: Dimension tolerance $\pm 5\%$