

ASSEMBLY INSTRUCTIONS
COASTER FINE FURNITURE



Fine Furniture for every stage of life

105362
Dining Side Chair

REVISION 0: 05/26/2014
REVISION 1: 08/19/2014
REVISION 2: 02/18/2016
REVISION 3: 11/13/2020

ITEM: 105362



ASSEMBLY INSTRUCTIONS

ASSEMBLY TIPS :

1. Remove hardware from box and sort by size.
2. Please check to see that all hardware and parts are present prior to start of assembly.
3. Please follow attached instructions in the same sequence as numbered to assure fast & easy assembly.



WARNING !

1. Don't attempt to repair or modify parts that are broken or defective. Please contact the store immediately.
2. This product is for home use only and not intended for commercial establishments.

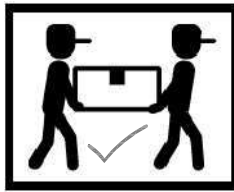

ASSEMBLY TIME

15 MINUTES

PARTS IDENTIFICATION

AF BACKREST



1PC

BF UPPER LEG FRAME

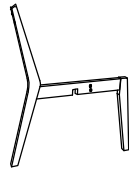

1PC

CF LOWER LEG FRAME

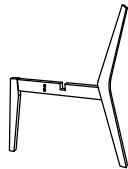

1PC

DF WOOD CLEAT



1PC

EF SEAT CUSHION



1PC

HARDWARE IDENTIFICATION

1 ALLEN WRENCH
(M4 x 110MM - BLK)



1PC

2 LONG BOLT
(M6 x 60MM - RBW)



4PCS

3 MEDIUM BOLT
(M6 x 35MM - RBW)



4PCS

4 SHORT BOLT
(M6 x 25MM - RBW)



4PCS

5 BOLT
(M7 x 50MM - ZB)

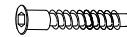

1PC

6 LOCK WASHER
(1/4" - BLK)



8PCS

7 FLAT WASHER
(M6 X 13MM - RBW)



4PCS

8 WOOD PLUG
(Ø14.5 X 9MM)



4PCS

NOTE :

Phillips head screw driver is required in the assembly process; However, manufacturer not provide this item. Quantities shown are for one chair.

ITEM: **105362**



ASSEMBLY INSTRUCTIONS

STEP 1

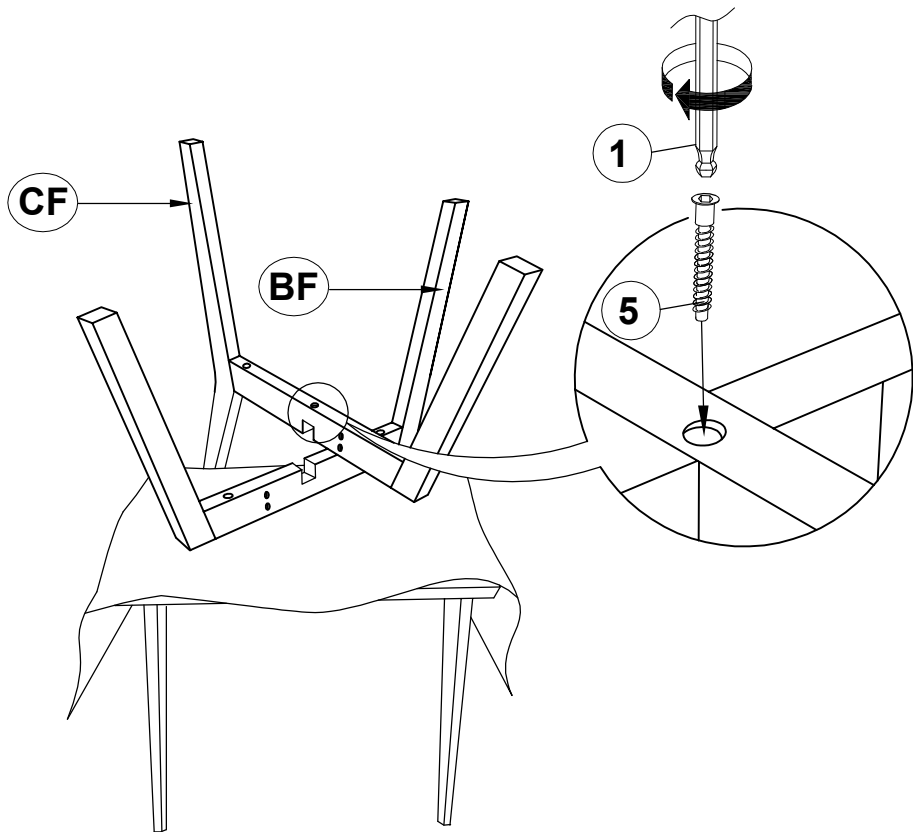

STEP 2

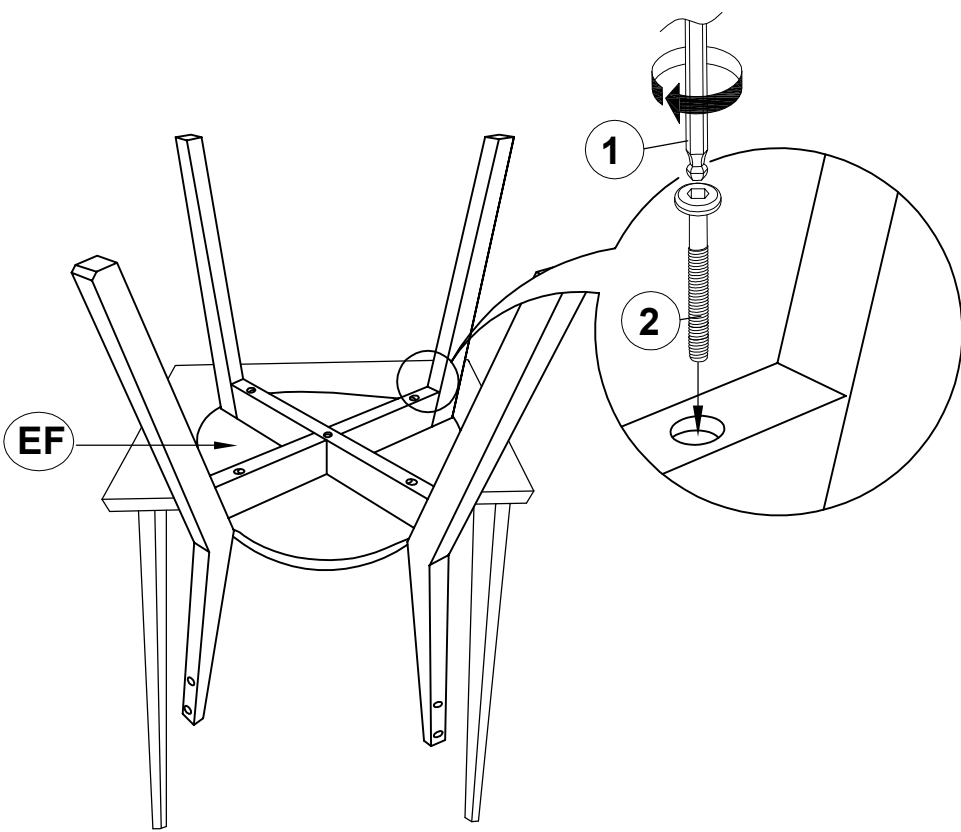

ITEM: **105362**

ASSEMBLY INSTRUCTIONS

STEP 3

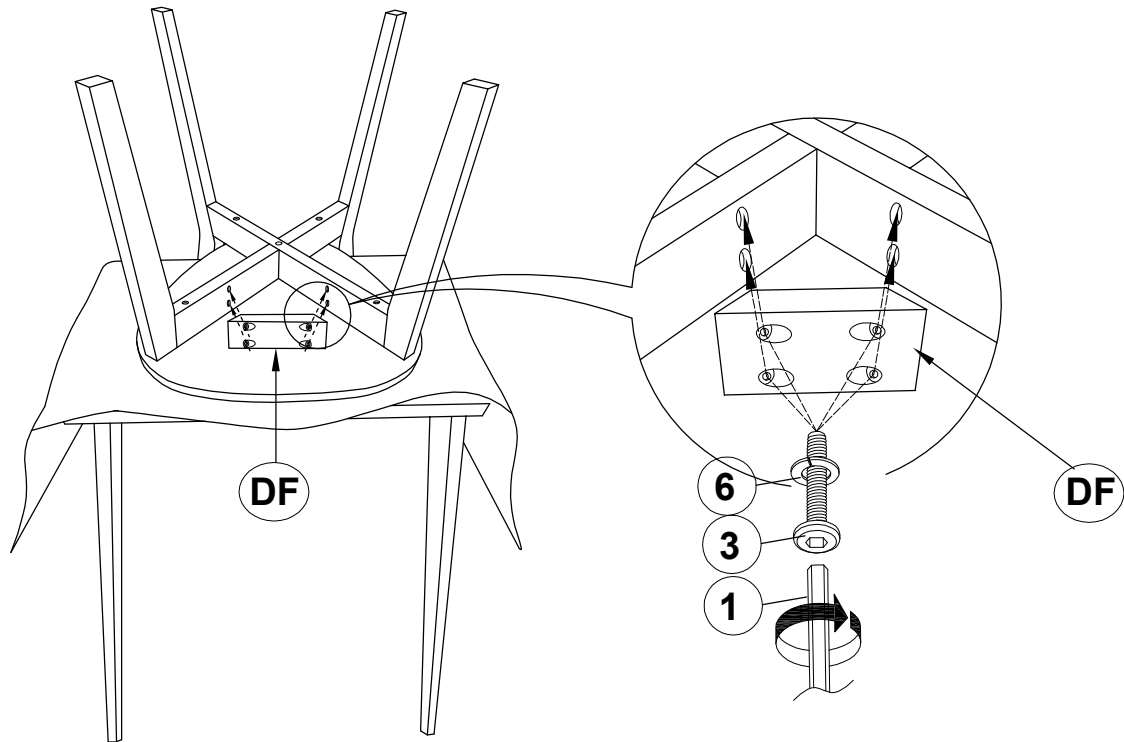

STEP 4

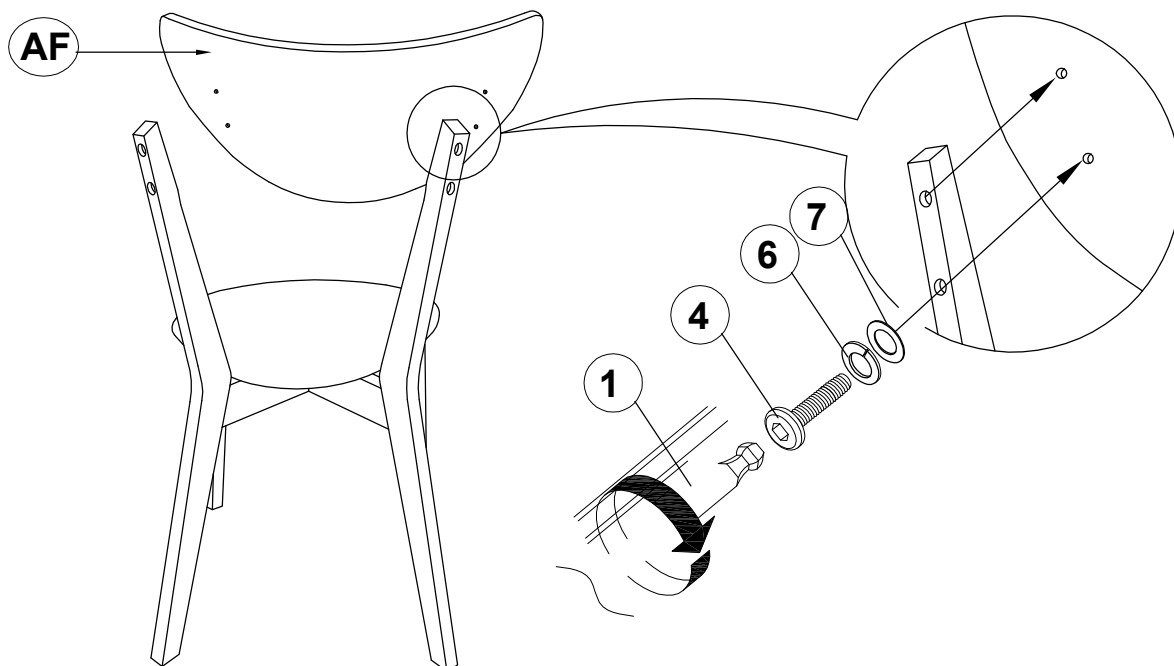

ITEM: **105362**



ASSEMBLY INSTRUCTIONS

STEP 5

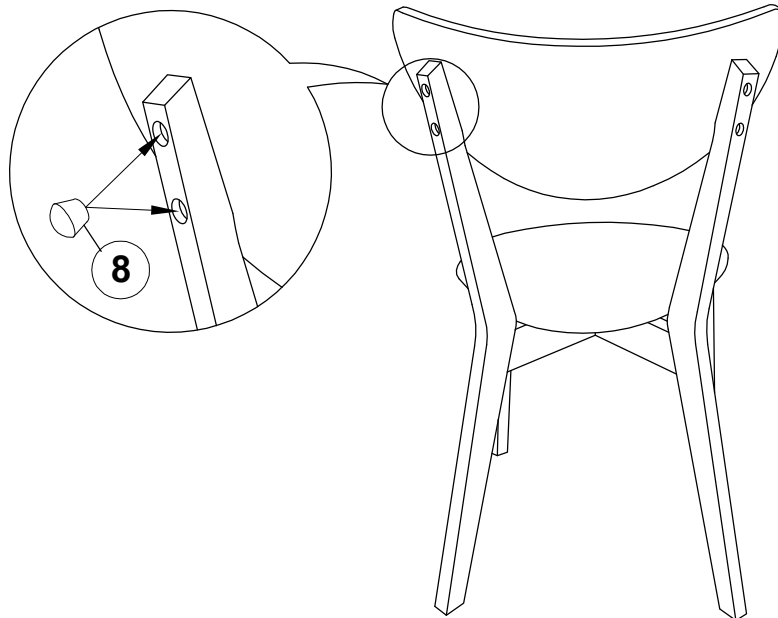

STEP 6
COMPLETE

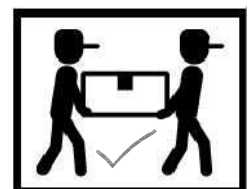
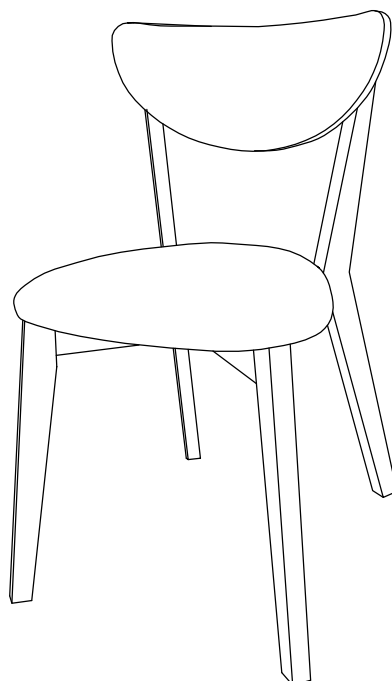

ITEM: **105362**

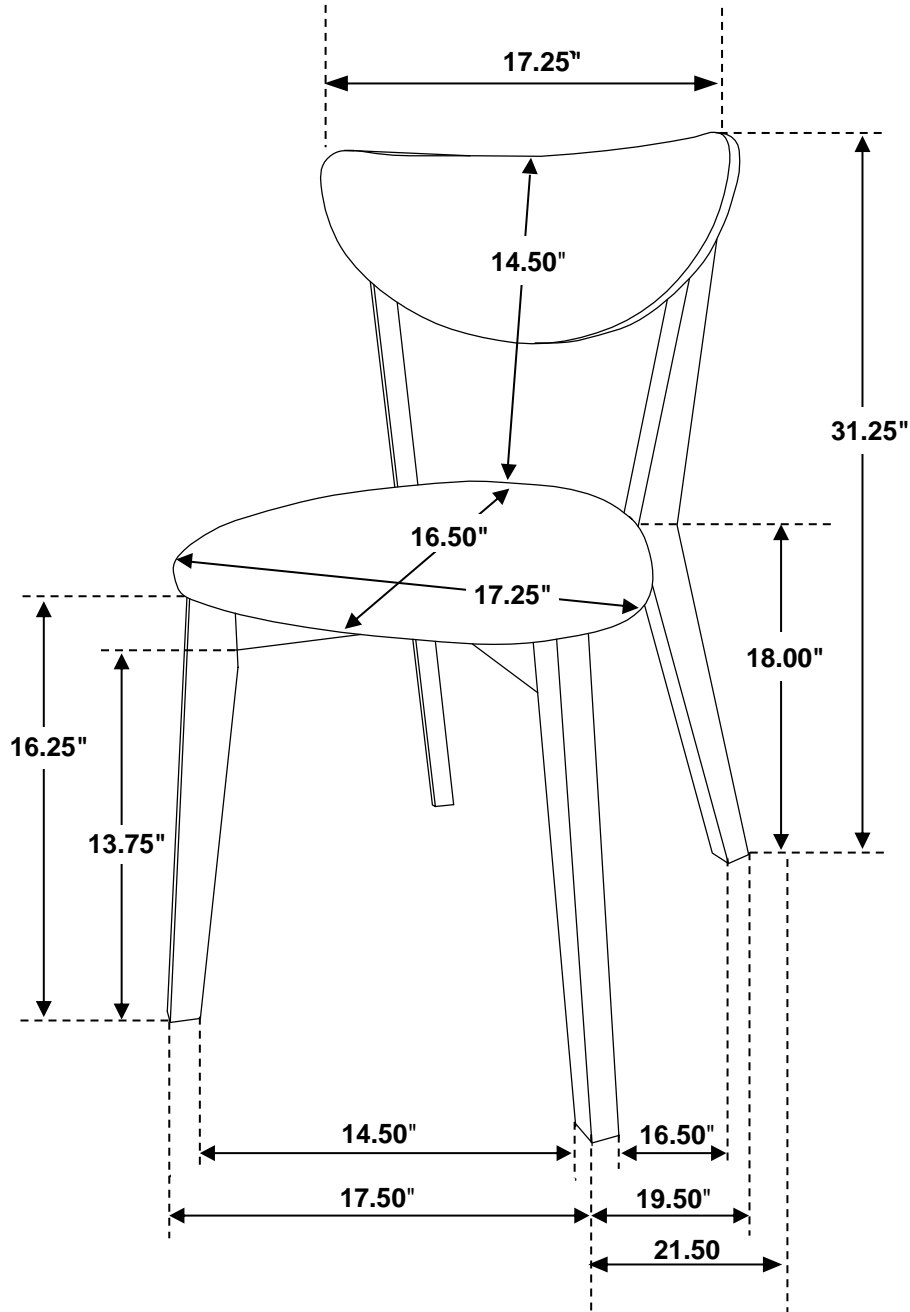

Note: Dimension tolerance $\pm 5\%$