

ASSEMBLY INSTRUCTIONS
COASTER FINE FURNITURE



Fine Furniture for every stage of life

115112

Dining Side Chair

ITEM: 115112



ASSEMBLY INSTRUCTIONS

ASSEMBLY TIPS :

1. Remove hardware from box and sort by size.
2. Please check to see that all hardware and parts are present prior to start of assembly.
3. Please follow attached instructions in the same sequence as numbered to assure fast & easy assembly.



WARNING !

1. Don't attempt to repair or modify parts that are broken or defective. Please contact the store immediately.
2. This product is for home use only and not intended for commercial establishments.

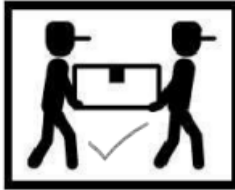

ASSEMBLY TIME

15 MINUTES

PARTS IDENTIFICATION

A	RIGHT LEG FRAME		1PC	D	SHORT RAIL		1PC
B	LEFT LEG FRAME		1PC	E	SEAT CUSHION		1PC
C	LONG RAIL		1PC	F	BACKREST		1PC

HARDWARE IDENTIFICATION

1	ALLEN WRENCH (M4 x 110MM - BLK)		1PC	5	FLAT WASHER (M6 X 13MM - RBW)		6PCS
2	LONG BOLT (M6 x 50MM - RBW)		4PCS	6	PAN HEAD SCREW (#8 x 1 1/4" - BLK)		4PCS
3	SHORT BOLT (M6 x 35MM - RBW)		2PCS	7	WOOD DOWEL (M10 x 30MM)		2PCS
4	LOCK WASHER (1/4" - BLK)		6PCS	8	WOOD PLUG (Ø14.5 X 9MM)		2PCS

NOTE :

Phillips head screw driver is required in the assembly process ; However, manufacturer not provide this item. Quantities shown are for one chair.

ITEM: 115112

ASSEMBLY INSTRUCTIONS

STEP 1

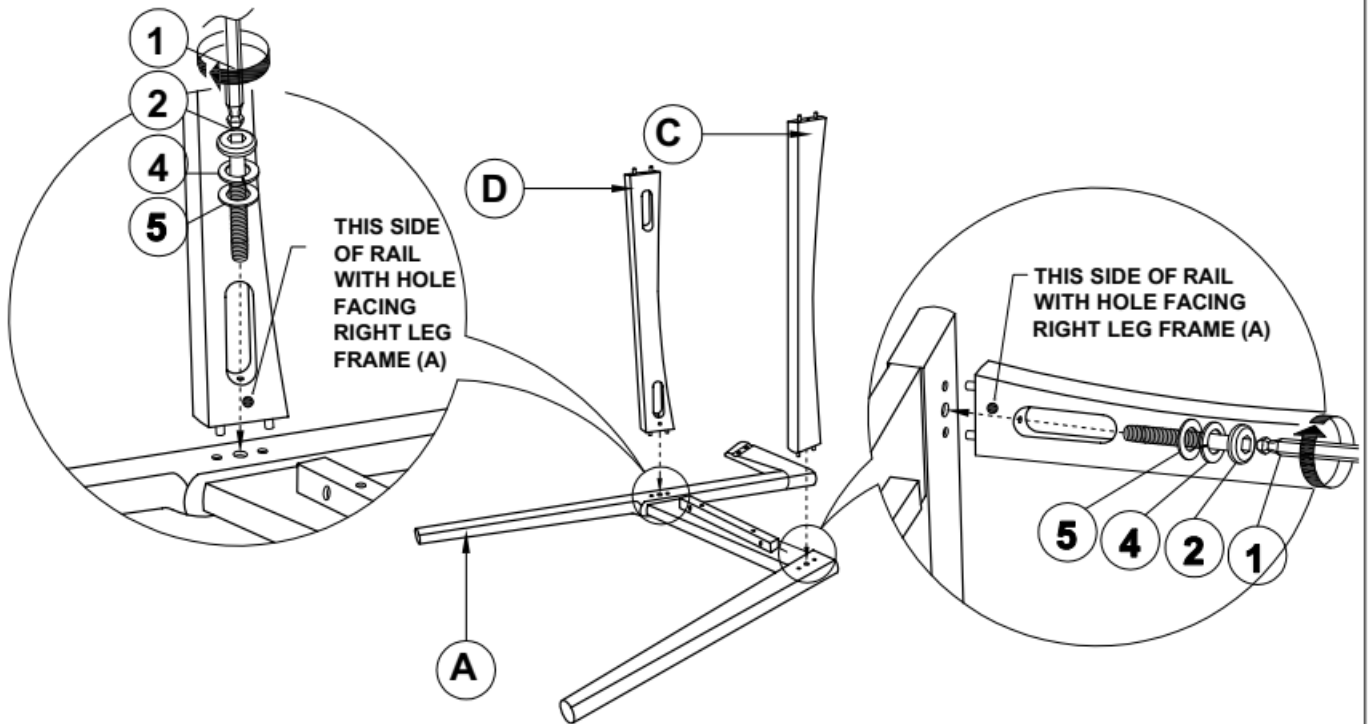

STEP 2

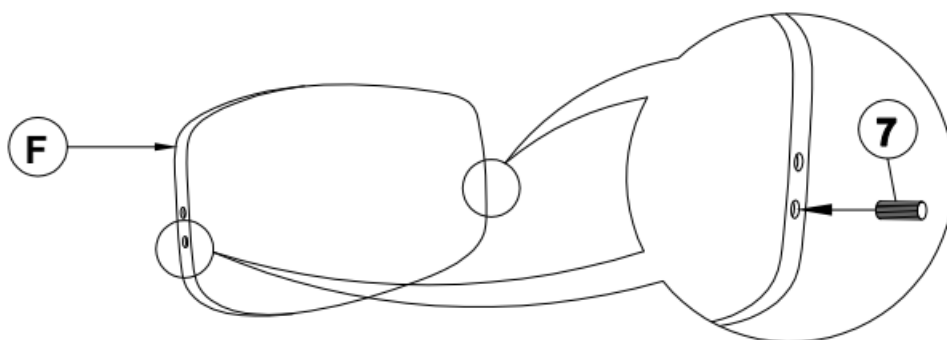

ITEM: **115112**
ASSEMBLY INSTRUCTIONS



STEP 3

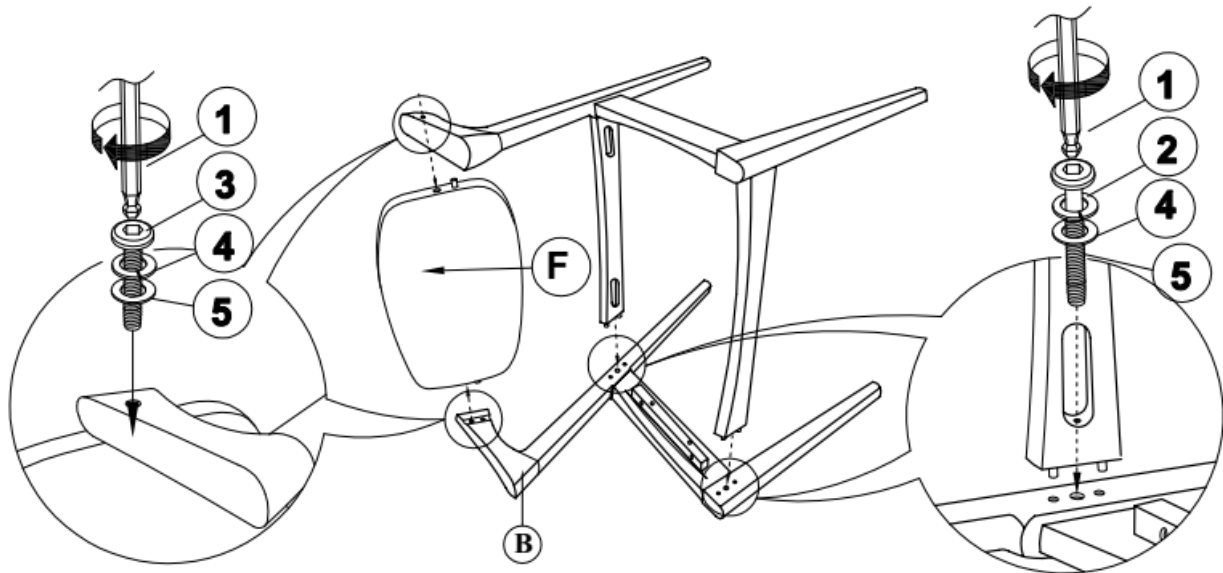

STEP 4

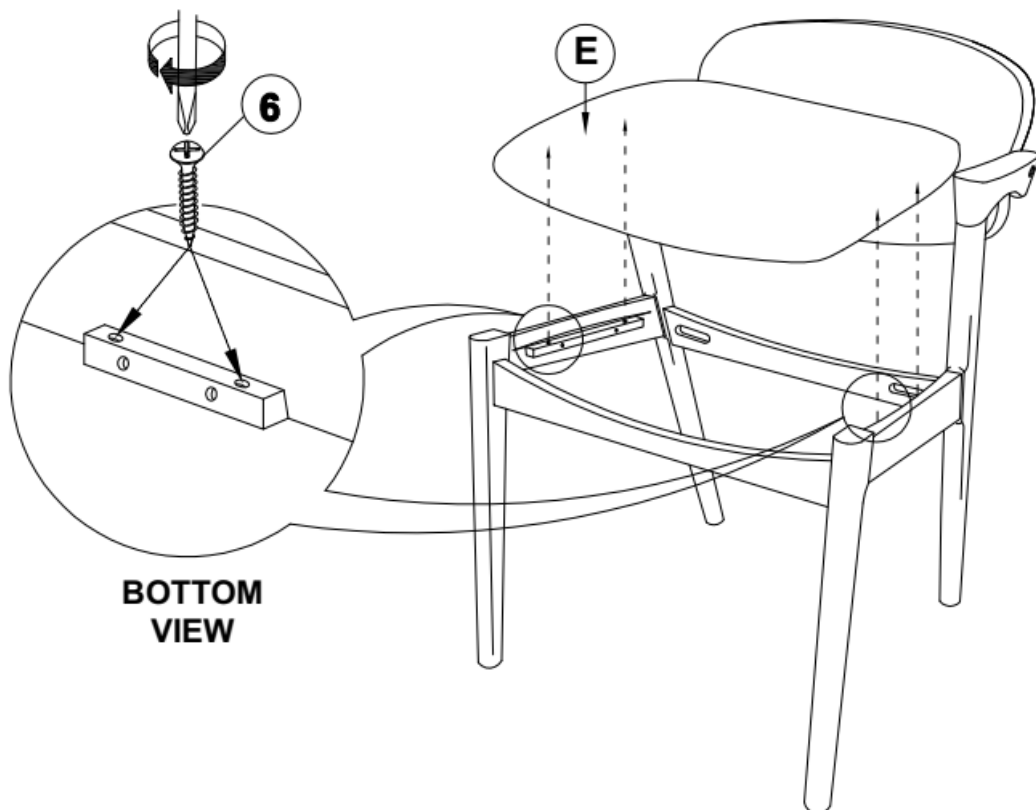

ITEM: **115112**
ASSEMBLY INSTRUCTIONS



STEP 5

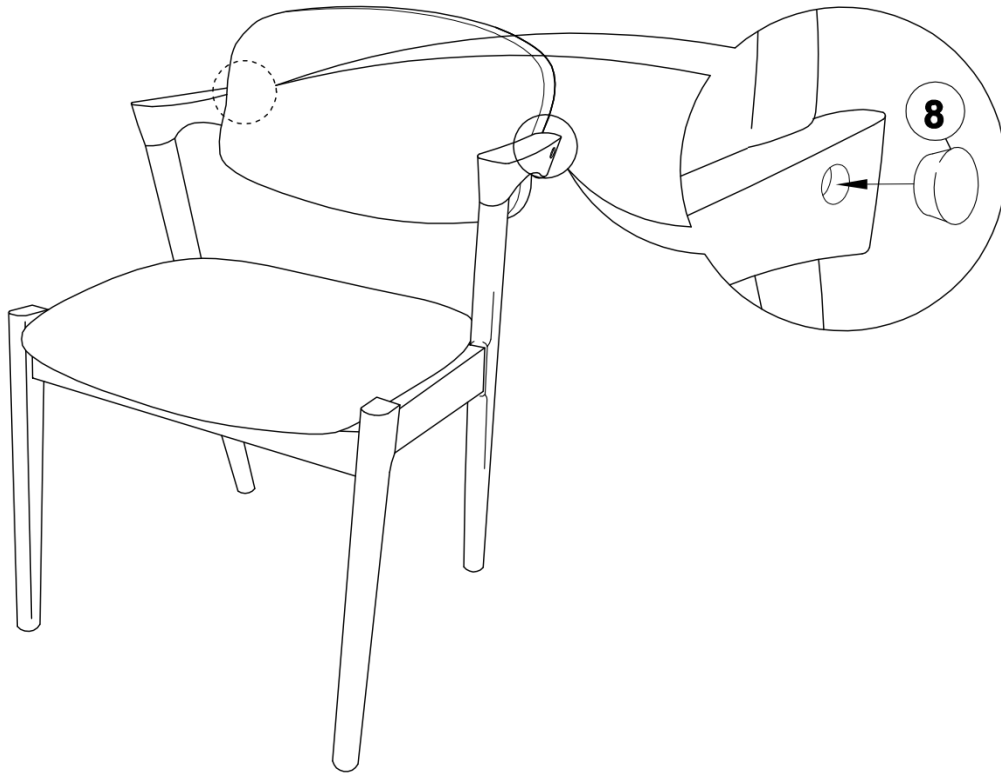

STEP 6
COMPLETE

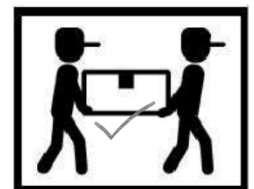

ITEM: **115112**

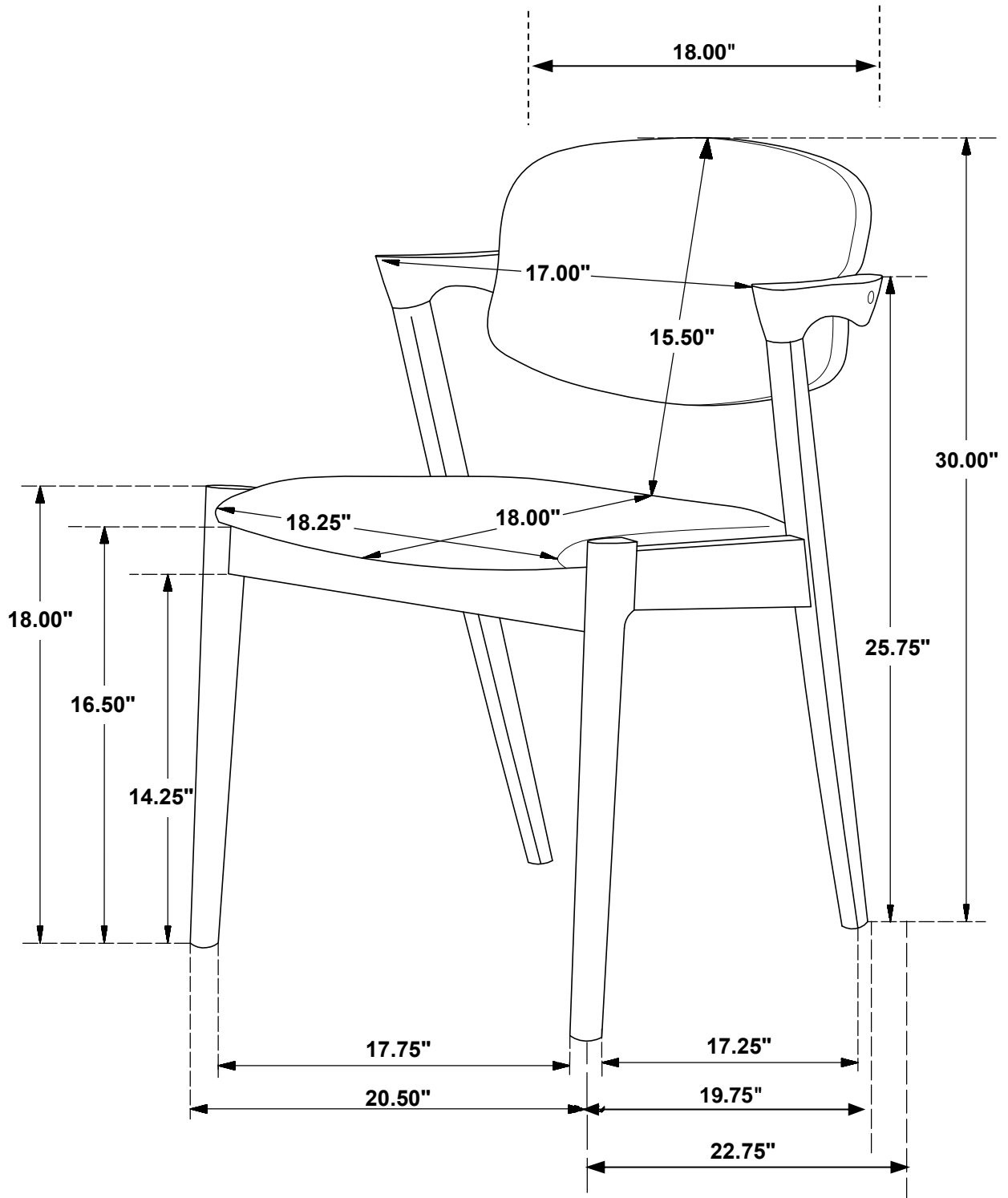

Note : Dimension tolerance $\pm 5\%$