

ASSEMBLY INSTRUCTIONS
COASTER FINE FURNITURE



Fine Furniture for every stage of life

551705
Armless Chair

ITEM: 551705



ASSEMBLY INSTRUCTIONS

ASSEMBLY TIPS:

1. Remove hardware from box and sort by size.
2. Please check to see that all hardware and parts are present prior to start of assembly.
3. Please follow attached instructions in the same sequence as numbered to assure fast & easy assembly.



WARNING!

1. Don't attempt to repair or modify parts that are broken or defective. Please contact the store immediately.
2. This product is for home use only and not intended for commercial establishments.

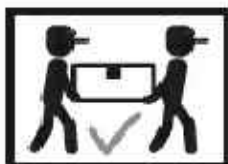

ASSEMBLY TIME

5 MINUTES

PARTS IDENTIFICATION

A SEAT



1PC

B BACK



1PC

C BACK CUSHION



1PC

D LEG



4PCS

HARDWARE IDENTIFICATION

1 HEX NUT

(Ø5/16"*6mm - RBW)



2PCS

2 FLAT WASHER

(Ø5/16"*16*1.5MM-RBW)



2PCS

3 THREADED BOLT

(Ø5/16"*85MM - RBW)



2PCS

4 WRENCH

(M13*89MM - RBW)



1PC

5 PLASTIC WASHER

(Ø50*2MM - BLK)



4PCS

6 LOCK WASHER

(Ø5/16"*2MM - RBW)



2PCS

ITEM: 551705

ASSEMBLY INSTRUCTIONS



STEP 1

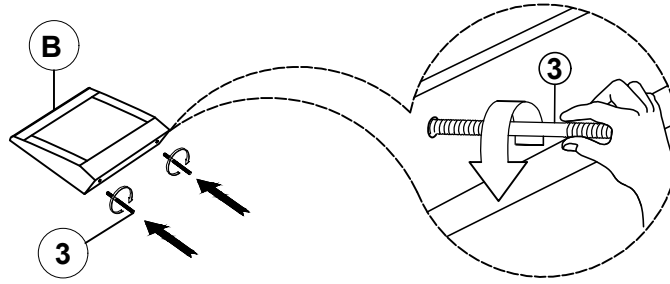

STEP 2

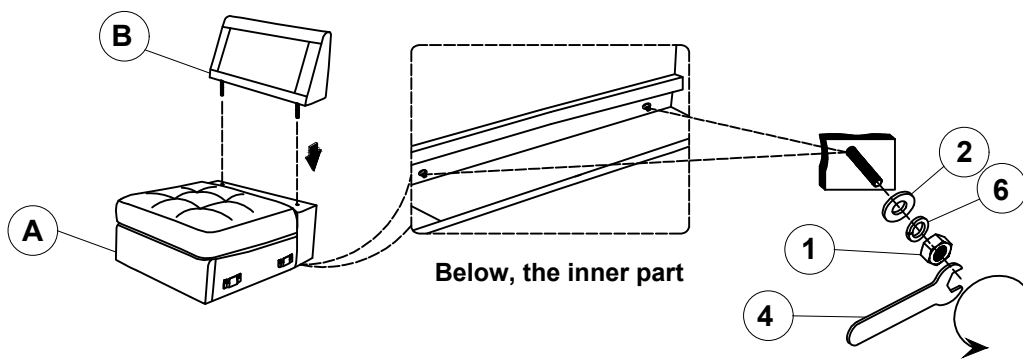

STEP 3

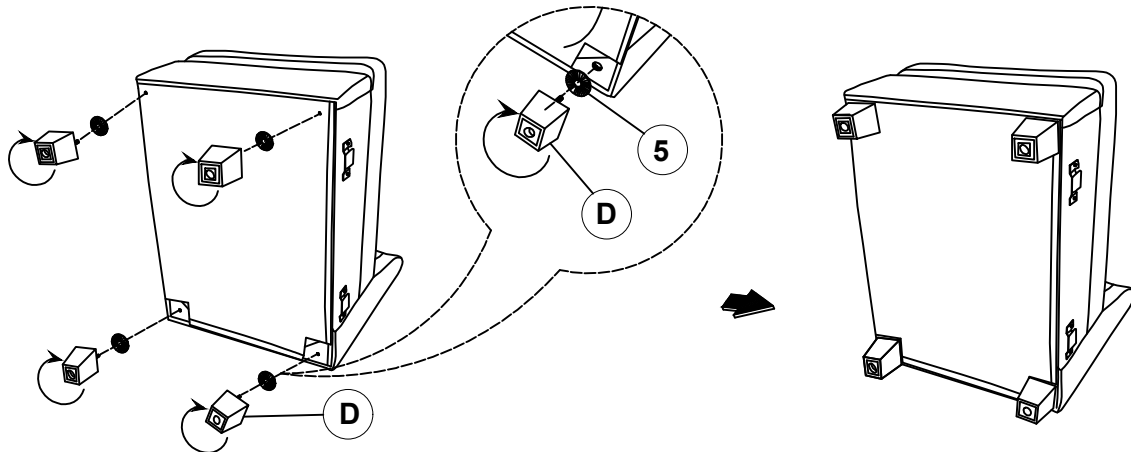

STEP 4 **COMPLETE**

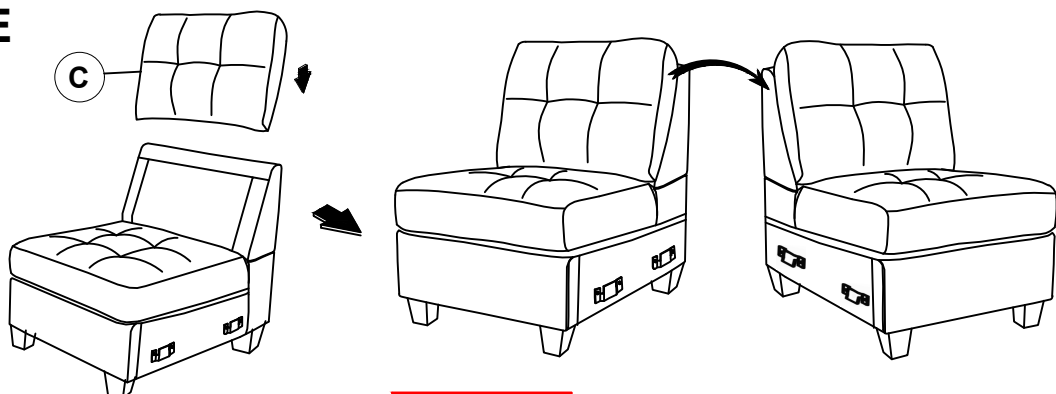

ITEM: 551705

ASSEMBLY INSTRUCTIONS



STEP 7

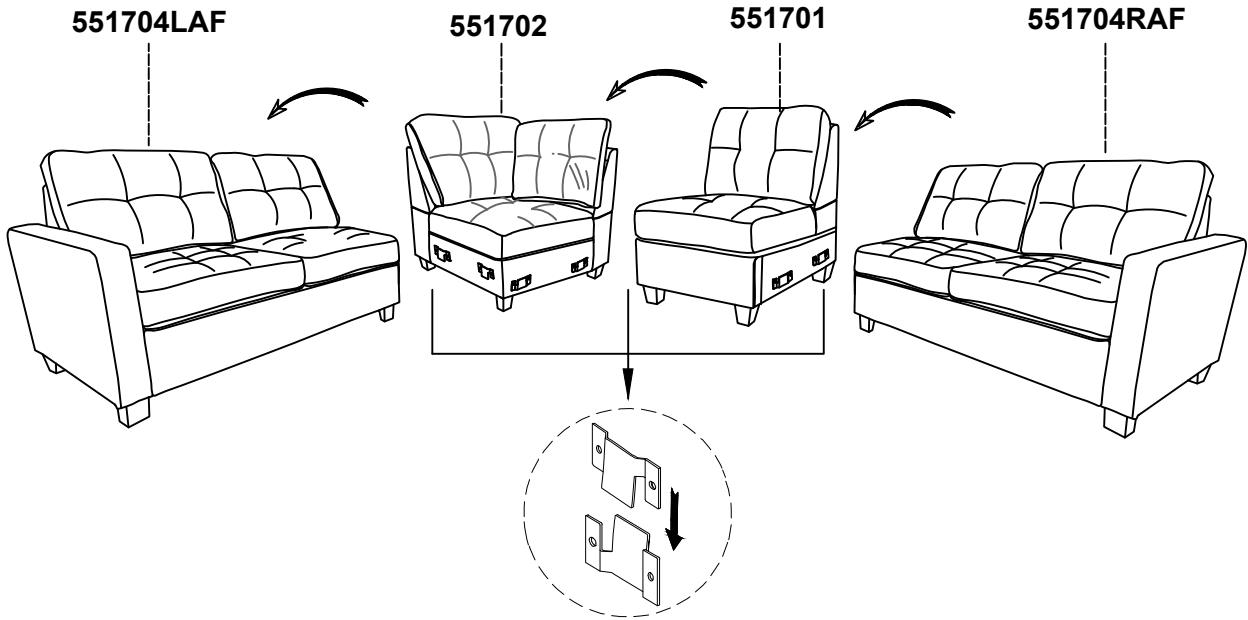

STEP 8

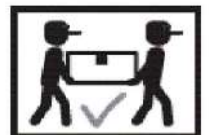
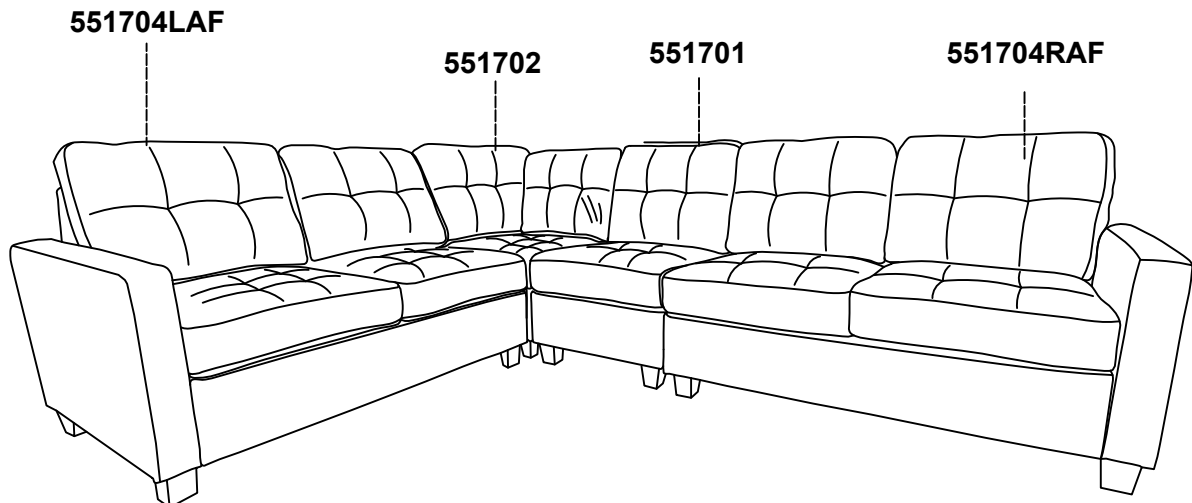

ITEM: 551705

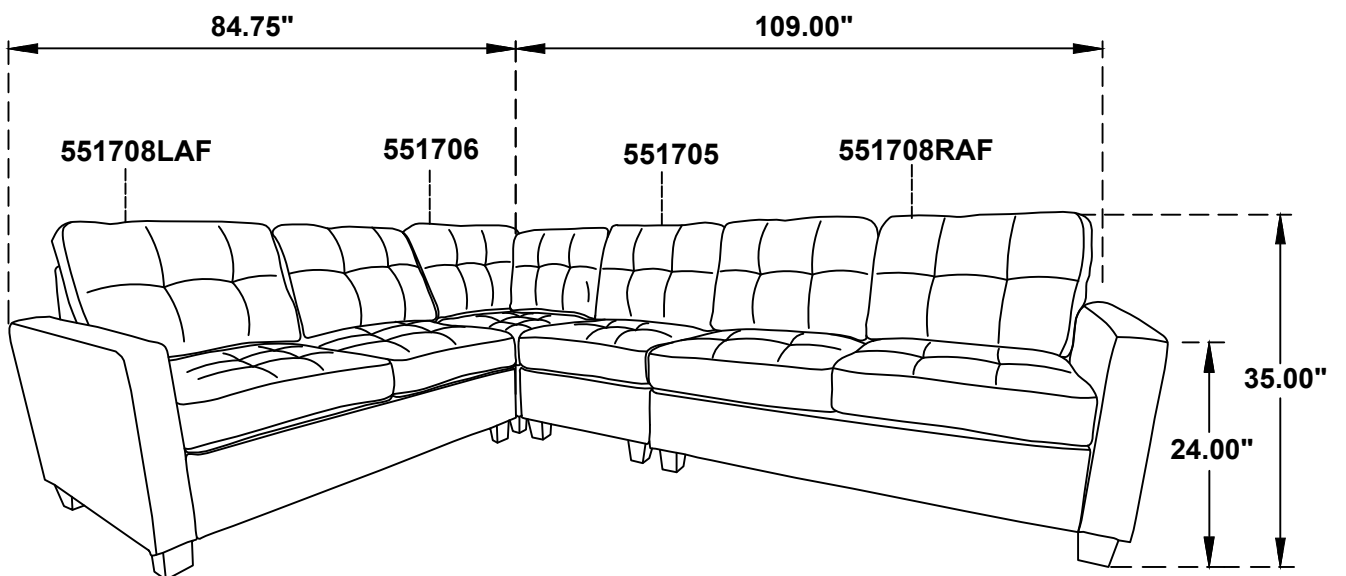
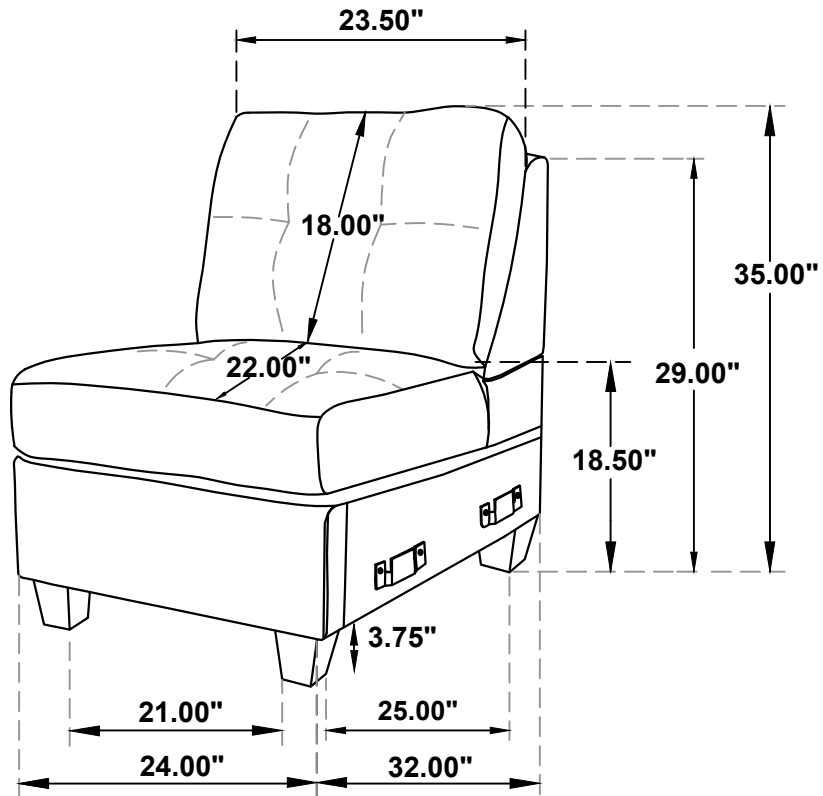

Note: Dimension tolerance $\pm 5\%$